

ARM[®] Compiler

Version 5.06

armasm User Guide



ARM® Compiler

armasm User Guide

Copyright © 2010-2016 ARM Limited or its affiliates. All rights reserved.

Release Information

Document History

Issue	Date	Confidentiality	Change
A	May 2010	Non-Confidential	ARM Compiler v4.1 Release
B	30 September 2010	Non-Confidential	Update 1 for ARM Compiler v4.1
C	28 January 2011	Non-Confidential	Update 2 for ARM Compiler v4.1 Patch 3
D	30 April 2011	Non-Confidential	ARM Compiler v5.0 Release
E	29 July 2011	Non-Confidential	Update 1 for ARM Compiler v5.0
F	30 September 2011	Non-Confidential	ARM Compiler v5.01 Release
G	29 February 2012	Non-Confidential	Document update 1 for ARM Compiler v5.01 Release
H	27 July 2012	Non-Confidential	ARM Compiler v5.02 Release
I	31 January 2013	Non-Confidential	ARM Compiler v5.03 Release
J	27 November 2013	Non-Confidential	ARM Compiler v5.04 Release
K	10 September 2014	Non-Confidential	ARM Compiler v5.05 Release
L	29 July 2015	Non-Confidential	ARM Compiler v5.06 Release
M	11 November 2016	Non-Confidential	Update 3 for ARM Compiler v5.06 Release

Non-Confidential Proprietary Notice

This document is protected by copyright and other related rights and the practice or implementation of the information contained in this document may be protected by one or more patents or pending patent applications. No part of this document may be reproduced in any form by any means without the express prior written permission of ARM. **No license, express or implied, by estoppel or otherwise to any intellectual property rights is granted by this document unless specifically stated.**

Your access to the information in this document is conditional upon your acceptance that you will not use or permit others to use the information for the purposes of determining whether implementations infringe any third party patents.

THIS DOCUMENT IS PROVIDED “AS IS”. ARM PROVIDES NO REPRESENTATIONS AND NO WARRANTIES, EXPRESS, IMPLIED OR STATUTORY, INCLUDING, WITHOUT LIMITATION, THE IMPLIED WARRANTIES OF MERCHANTABILITY, SATISFACTORY QUALITY, NON-INFRINGEMENT OR FITNESS FOR A PARTICULAR PURPOSE WITH RESPECT TO THE DOCUMENT. For the avoidance of doubt, ARM makes no representation with respect to, and has undertaken no analysis to identify or understand the scope and content of, third party patents, copyrights, trade secrets, or other rights.

This document may include technical inaccuracies or typographical errors.

TO THE EXTENT NOT PROHIBITED BY LAW, IN NO EVENT WILL ARM BE LIABLE FOR ANY DAMAGES, INCLUDING WITHOUT LIMITATION ANY DIRECT, INDIRECT, SPECIAL, INCIDENTAL, PUNITIVE, OR CONSEQUENTIAL DAMAGES, HOWEVER CAUSED AND REGARDLESS OF THE THEORY OF LIABILITY, ARISING OUT OF ANY USE OF THIS DOCUMENT, EVEN IF ARM HAS BEEN ADVISED OF THE POSSIBILITY OF SUCH DAMAGES.

This document consists solely of commercial items. You shall be responsible for ensuring that any use, duplication or disclosure of this document complies fully with any relevant export laws and regulations to assure that this document or any portion thereof is not exported, directly or indirectly, in violation of such export laws. Use of the word “partner” in reference to ARM’s customers is not intended to create or refer to any partnership relationship with any other company. ARM may make changes to this document at any time and without notice.

If any of the provisions contained in these terms conflict with any of the provisions of any signed written agreement covering this document with ARM, then the signed written agreement prevails over and supersedes the conflicting provisions of these terms. This document may be translated into other languages for convenience, and you agree that if there is any conflict between the English version of this document and any translation, the terms of the English version of the Agreement shall prevail.

Words and logos marked with ® or ™ are registered trademarks or trademarks of ARM Limited or its affiliates in the EU and/or elsewhere. All rights reserved. Other brands and names mentioned in this document may be the trademarks of their respective owners. Please follow ARM's trademark usage guidelines at <http://www.arm.com/about/trademark-usage-guidelines.php>

Copyright © 2010-2016, ARM Limited or its affiliates. All rights reserved.

ARM Limited. Company 02557590 registered in England.

110 Fulbourn Road, Cambridge, England CB1 9NJ.

LES-PRE-20349

Confidentiality Status

This document is Non-Confidential. The right to use, copy and disclose this document may be subject to license restrictions in accordance with the terms of the agreement entered into by ARM and the party that ARM delivered this document to.

Unrestricted Access is an ARM internal classification.

Product Status

The information in this document is Final, that is for a developed product.

Web Address

<http://www.arm.com>

Contents

ARM® Compiler armasm User Guide

Preface

About this book 24

Chapter 1

Overview of the Assembler

1.1 *About the ARM Compiler toolchain assemblers* 1-28
1.2 *Key features of the assembler* 1-29
1.3 *How the assembler works* 1-30
1.4 *Directives that can be omitted in pass 2 of the assembler* 1-32

Chapter 2

Overview of the ARM Architecture

2.1 *About the ARM architecture* 2-35
2.2 *ARM, Thumb, and ThumbEE instruction sets* 2-36
2.3 *Changing between ARM, Thumb, and ThumbEE state* 2-37
2.4 *Processor modes, and privileged and unprivileged software execution* 2-38
2.5 *Processor modes in ARMv6-M and ARMv7-M* 2-39
2.6 *NEON technology* 2-40
2.7 *VFP hardware* 2-41
2.8 *ARM registers* 2-42
2.9 *General-purpose registers* 2-44
2.10 *Register accesses* 2-45
2.11 *Predeclared core register names* 2-46
2.12 *Predeclared extension register names* 2-47
2.13 *Predeclared XScale register names* 2-48
2.14 *Predeclared coprocessor names* 2-49

2.15	Program Counter	2-50
2.16	Application Program Status Register	2-51
2.17	The Q flag	2-52
2.18	Current Program Status Register	2-53
2.19	Saved Program Status Registers	2-54
2.20	ARM and Thumb instruction set overview	2-55
2.21	Access to the inline barrel shifter	2-56

Chapter 3

Structure of Assembly Language Modules

3.1	Syntax of source lines in assembly language	3-58
3.2	Literals	3-60
3.3	ELF sections and the AREA directive	3-61
3.4	An example ARM assembly language module	3-62

Chapter 4

Writing ARM Assembly Language

4.1	About the Unified Assembler Language	4-65
4.2	Register usage in subroutine calls	4-66
4.3	Load immediate values	4-67
4.4	Load immediate values using MOV and MVN	4-68
4.5	Load immediate values using MOV32	4-69
4.6	Load immediate values using LDR Rd, =const	4-70
4.7	Literal pools	4-71
4.8	Load addresses into registers	4-73
4.9	Load addresses to a register using ADR	4-74
4.10	Load addresses to a register using ADRL	4-76
4.11	Load addresses to a register using LDR Rd, =label	4-77
4.12	Other ways to load and store registers	4-79
4.13	Load and store multiple register instructions	4-80
4.14	Load and store multiple register instructions in ARM and Thumb	4-81
4.15	Stack implementation using LDM and STM	4-82
4.16	Stack operations for nested subroutines	4-84
4.17	Block copy with LDM and STM	4-85
4.18	Memory accesses	4-87
4.19	The Read-Modify-Write operation	4-88
4.20	Optional hash with immediate constants	4-89
4.21	Use of macros	4-90
4.22	Test-and-branch macro example	4-91
4.23	Unsigned integer division macro example	4-92
4.24	Instruction and directive relocations	4-94
4.25	Symbol versions	4-96
4.26	Frame directives	4-97
4.27	Exception tables and Unwind tables	4-98
4.28	Assembly language changes after RVCT v2.1	4-99

Chapter 5

Condition Codes

5.1	Conditional instructions	5-102
5.2	Conditional execution in ARM state	5-103
5.3	Conditional execution in Thumb state	5-104
5.4	Updates to the condition flags	5-105
5.5	Condition code suffixes and related flags	5-106

5.6	Comparison of condition code meanings in integer and floating-point code	5-107
5.7	Benefits of using conditional execution	5-109
5.8	Example showing the benefits of using conditional instructions	5-110
5.9	Optimization for execution speed	5-113

Chapter 6

Using the Assembler

6.1	armasm command-line syntax	6-115
6.2	Specify command-line options with an environment variable	6-116
6.3	Using stdin to input source code to the assembler	6-117
6.4	Built-in variables and constants	6-118
6.5	Identifying versions of armasm in source code	6-122
6.6	Diagnostic messages	6-123
6.7	Interlocks diagnostics	6-124
6.8	Automatic IT block generation	6-125
6.9	Thumb branch target alignment	6-126
6.10	Thumb code size diagnostics	6-127
6.11	ARM and Thumb instruction portability diagnostics	6-128
6.12	Instruction width diagnostics	6-129
6.13	Two pass assembler diagnostics	6-130
6.14	Conditional assembly	6-131
6.15	Using the C preprocessor	6-132
6.16	Address alignment	6-134
6.17	Instruction width selection in Thumb	6-135

Chapter 7

Symbols, Literals, Expressions, and Operators

7.1	Symbol naming rules	7-138
7.2	Variables	7-139
7.3	Numeric constants	7-140
7.4	Assembly time substitution of variables	7-141
7.5	Register-relative and PC-relative expressions	7-142
7.6	Labels	7-143
7.7	Labels for PC-relative addresses	7-144
7.8	Labels for register-relative addresses	7-145
7.9	Labels for absolute addresses	7-146
7.10	Numeric local labels	7-147
7.11	Syntax of numeric local labels	7-148
7.12	String expressions	7-149
7.13	String literals	7-150
7.14	Numeric expressions	7-151
7.15	Syntax of numeric literals	7-152
7.16	Syntax of floating-point literals	7-153
7.17	Logical expressions	7-154
7.18	Logical literals	7-155
7.19	Unary operators	7-156
7.20	Binary operators	7-157
7.21	Multiplicative operators	7-158
7.22	String manipulation operators	7-159
7.23	Shift operators	7-160
7.24	Addition, subtraction, and logical operators	7-161
7.25	Relational operators	7-162

7.26	Boolean operators	7-163
7.27	Operator precedence	7-164
7.28	Difference between operator precedence in assembly language and C	7-165

Chapter 8

NEON Programming

8.1	Architecture support for NEON	8-168
8.2	Half-precision extension for NEON	8-169
8.3	Fused Multiply-Add extension for NEON	8-170
8.4	Extension register bank mapping in NEON	8-171
8.5	NEON views of the extension register bank	8-173
8.6	Load values to NEON registers	8-174
8.7	Conditional execution of NEON instructions	8-175
8.8	Floating-point exceptions in NEON	8-176
8.9	NEON data types	8-177
8.10	Extended notation extension for NEON	8-178
8.11	NEON vectors	8-179
8.12	Normal, long, wide, and narrow NEON operation	8-180
8.13	Saturating NEON instructions	8-181
8.14	NEON scalars	8-182
8.15	Polynomial arithmetic over $\{0, 1\}$	8-183
8.16	NEON system registers	8-184
8.17	Flush-to-zero mode in NEON	8-185
8.18	NEON operations not affected by flush-to-zero mode	8-186
8.19	When to use flush-to-zero mode in NEON	8-187
8.20	The effects of using flush-to-zero mode in NEON	8-188

Chapter 9

VFP Programming

9.1	Architecture support for VFP	9-191
9.2	Half-precision extension for VFP	9-192
9.3	Fused Multiply-Add extension for VFP	9-193
9.4	Extension register bank mapping in VFP	9-194
9.5	VFP views of the extension register bank	9-196
9.6	Load values to VFP registers	9-197
9.7	Conditional execution of VFP instructions	9-198
9.8	Floating-point exceptions in VFP	9-199
9.9	VFP data types	9-200
9.10	Extended notation extension for VFP	9-201
9.11	VFP system registers	9-202
9.12	Flush-to-zero mode	9-203
9.13	When to use flush-to-zero mode in VFP	9-204
9.14	The effects of using flush-to-zero mode in VFP	9-205
9.15	VFP operations not affected by flush-to-zero mode	9-206
9.16	VFP vector mode	9-207
9.17	Vectors in the VFP extension register bank	9-208
9.18	VFP vector wrap-around	9-210
9.19	VFP vector stride	9-211
9.20	Restriction on vector length	9-212
9.21	Control of scalar, vector, and mixed operations	9-213
9.22	Overview of VFP directives and vector notation	9-214
9.23	Pre-UAL VFP syntax and mnemonics	9-215

9.24	Vector notation	9-217
9.25	VFPASSERT SCALAR	9-218
9.26	VFPASSERT VECTOR	9-219

Chapter 10

Assembler Command-line Options

10.1	--16	10-223
10.2	--32	10-224
10.3	--apcs=qualifier...qualifier	10-225
10.4	--arm	10-227
10.5	--arm_only	10-228
10.6	--bi	10-229
10.7	--bigend	10-230
10.8	--brief_diagnostics, --no_brief_diagnostics	10-231
10.9	--checkreglist	10-232
10.10	--comment_section, --no_comment_section	10-233
10.11	--compatible=name	10-234
10.12	--cpreproc	10-235
10.13	--cpreproc_opts=option[,option,...]	10-236
10.14	--cpu=list	10-237
10.15	--cpu=name	10-238
10.16	--debug	10-241
10.17	--depend=dependfile	10-242
10.18	--depend_format=string	10-243
10.19	--diag_error=tag[,tag,...]	10-244
10.20	--diag_remark=tag[,tag,...]	10-245
10.21	--diag_style={arm ide gnu}	10-246
10.22	--diag_suppress=tag[,tag,...]	10-247
10.23	--diag_warning=tag[,tag,...]	10-248
10.24	--dllexport_all	10-249
10.25	--dwarf2	10-250
10.26	--dwarf3	10-251
10.27	--errors=errorfile	10-252
10.28	--execstack, --no_execstack	10-253
10.29	--execute_only	10-254
10.30	--exceptions, --no_exceptions	10-255
10.31	--exceptions_unwind, --no_exceptions_unwind	10-256
10.32	--fpmode=model	10-257
10.33	--fpu=list	10-258
10.34	--fpu=name	10-259
10.35	--g	10-261
10.36	--help	10-262
10.37	--idir[,dir,...]	10-263
10.38	--keep	10-264
10.39	--length=n	10-265
10.40	--li	10-266
10.41	--library_type=lib	10-267
10.42	--list=file	10-268
10.43	--list=	10-269
10.44	--littleend	10-270
10.45	--m	10-271

10.46	--maxcache=n	10-272
10.47	--md	10-273
10.48	--no_code_gen	10-274
10.49	--no_esc	10-275
10.50	--no_hide_all	10-276
10.51	--no_regs	10-277
10.52	--no_terse	10-278
10.53	--no_warn	10-279
10.54	-o filename	10-280
10.55	--pd	10-281
10.56	--predefine "directive"	10-282
10.57	--reduce_paths, --no_reduce_paths	10-283
10.58	--regnames	10-284
10.59	--report-if-not-wysiwyg	10-285
10.60	--show_cmdline	10-286
10.61	--split_ldm	10-287
10.62	--thumb	10-288
10.63	--thumbx	10-289
10.64	--unaligned_access, --no_unaligned_access	10-290
10.65	--unsafe	10-291
10.66	--untyped_local_labels	10-292
10.67	--version_number	10-293
10.68	--via=filename	10-294
10.69	--vsn	10-295
10.70	--width=n	10-296
10.71	--xref	10-297

Chapter 11

ARM and Thumb Instructions

11.1	ARM and Thumb instruction summary	11-303
11.2	Instruction width specifiers	11-311
11.3	Flexible second operand (Operand2)	11-312
11.4	Syntax of Operand2 as a constant	11-313
11.5	Syntax of Operand2 as a register with optional shift	11-314
11.6	Shift operations	11-315
11.7	Saturating instructions	11-318
11.8	Condition code suffixes	11-319
11.9	ADC	11-320
11.10	ADD	11-322
11.11	ADR (PC-relative)	11-325
11.12	ADR (register-relative)	11-327
11.13	ADRL pseudo-instruction	11-329
11.14	AND	11-331
11.15	ASR	11-333
11.16	B	11-335
11.17	BFC	11-337
11.18	BFI	11-338
11.19	BIC	11-339
11.20	BKPT	11-341
11.21	BL	11-342
11.22	BLX	11-344

11.23	<i>BX</i>	11-346
11.24	<i>BXJ</i>	11-348
11.25	<i>CBZ and CBNZ</i>	11-349
11.26	<i>CDP and CDP2</i>	11-350
11.27	<i>CLREX</i>	11-351
11.28	<i>CLZ</i>	11-352
11.29	<i>CMP and CMN</i>	11-353
11.30	<i>CPS</i>	11-355
11.31	<i>CPY pseudo-instruction</i>	11-357
11.32	<i>DBG</i>	11-358
11.33	<i>DMB</i>	11-359
11.34	<i>DSB</i>	11-361
11.35	<i>EOR</i>	11-363
11.36	<i>ERET</i>	11-365
11.37	<i>HVC</i>	11-366
11.38	<i>ISB</i>	11-367
11.39	<i>IT</i>	11-368
11.40	<i>LDC and LDC2</i>	11-370
11.41	<i>LDM</i>	11-372
11.42	<i>LDR (immediate offset)</i>	11-374
11.43	<i>LDR (PC-relative)</i>	11-377
11.44	<i>LDR (register offset)</i>	11-380
11.45	<i>LDR (register-relative)</i>	11-383
11.46	<i>LDR pseudo-instruction</i>	11-386
11.47	<i>LDR, unprivileged</i>	11-388
11.48	<i>LDREX</i>	11-390
11.49	<i>LSL</i>	11-392
11.50	<i>LSR</i>	11-394
11.51	<i>MAR</i>	11-396
11.52	<i>MCR and MCR2</i>	11-397
11.53	<i>MCRR and MCRR2</i>	11-398
11.54	<i>MIA, MIAPH, and MIAxy</i>	11-399
11.55	<i>MLA</i>	11-401
11.56	<i>MLS</i>	11-402
11.57	<i>MOV</i>	11-403
11.58	<i>MOV32 pseudo-instruction</i>	11-405
11.59	<i>MOVT</i>	11-406
11.60	<i>MRA</i>	11-407
11.61	<i>MRC and MRC2</i>	11-408
11.62	<i>MRRC and MRRC2</i>	11-409
11.63	<i>MRS (PSR to general-purpose register)</i>	11-410
11.64	<i>MRS (system coprocessor register to ARM register)</i>	11-412
11.65	<i>MSR (ARM register to system coprocessor register)</i>	11-413
11.66	<i>MSR (general-purpose register to PSR)</i>	11-414
11.67	<i>MUL</i>	11-416
11.68	<i>MVN</i>	11-418
11.69	<i>NEG pseudo-instruction</i>	11-420
11.70	<i>NOP</i>	11-421
11.71	<i>ORN (Thumb only)</i>	11-422
11.72	<i>ORR</i>	11-423

11.73	<i>PKHBT and PKHTB</i>	11-425
11.74	<i>PLD, PLDW, and PLI</i>	11-427
11.75	<i>POP</i>	11-429
11.76	<i>PUSH</i>	11-431
11.77	<i>QADD</i>	11-432
11.78	<i>QADD8</i>	11-433
11.79	<i>QADD16</i>	11-434
11.80	<i>QASX</i>	11-435
11.81	<i>QDADD</i>	11-436
11.82	<i>QDSUB</i>	11-437
11.83	<i>QSAX</i>	11-438
11.84	<i>QSUB</i>	11-439
11.85	<i>QSUB8</i>	11-440
11.86	<i>QSUB16</i>	11-441
11.87	<i>RBIT</i>	11-442
11.88	<i>REV</i>	11-443
11.89	<i>REV16</i>	11-444
11.90	<i>REVSH</i>	11-445
11.91	<i>RFE</i>	11-446
11.92	<i>ROR</i>	11-448
11.93	<i>RRX</i>	11-450
11.94	<i>RSB</i>	11-452
11.95	<i>RSC</i>	11-454
11.96	<i>SADD8</i>	11-456
11.97	<i>SADD16</i>	11-457
11.98	<i>SASX</i>	11-458
11.99	<i>SBC</i>	11-460
11.100	<i>SBFX</i>	11-462
11.101	<i>SDIV</i>	11-463
11.102	<i>SEL</i>	11-464
11.103	<i>SETEND</i>	11-466
11.104	<i>SEV</i>	11-467
11.105	<i>SHADD8</i>	11-468
11.106	<i>SHADD16</i>	11-469
11.107	<i>SHASX</i>	11-470
11.108	<i>SHSAX</i>	11-471
11.109	<i>SHSUB8</i>	11-472
11.110	<i>SHSUB16</i>	11-473
11.111	<i>SMC</i>	11-474
11.112	<i>SMLA_{xy}</i>	11-475
11.113	<i>SMLAD</i>	11-477
11.114	<i>SMLAL</i>	11-478
11.115	<i>SMLALD</i>	11-479
11.116	<i>SMLAL_{xy}</i>	11-480
11.117	<i>SMLAW_y</i>	11-481
11.118	<i>SMLSD</i>	11-482
11.119	<i>SMLS_{LD}</i>	11-483
11.120	<i>SMMLA</i>	11-484
11.121	<i>SMMLS</i>	11-485
11.122	<i>SMMUL</i>	11-486

11.123	SMUAD	11-487
11.124	SMULxy	11-488
11.125	SMULL	11-489
11.126	SMULWy	11-490
11.127	SMUSD	11-491
11.128	SRS	11-492
11.129	SSAT	11-494
11.130	SSAT16	11-495
11.131	SSAX	11-496
11.132	SSUB8	11-497
11.133	SSUB16	11-498
11.134	STC and STC2	11-499
11.135	STM	11-501
11.136	STR (immediate offset)	11-503
11.137	STR (register offset)	11-506
11.138	STR, unprivileged	11-509
11.139	STREX	11-511
11.140	SUB	11-513
11.141	SUBS pc, lr	11-515
11.142	SVC	11-517
11.143	SWP and SWPB	11-518
11.144	SXTAB	11-519
11.145	SXTAB16	11-520
11.146	SXTAH	11-521
11.147	SXTB	11-522
11.148	SXTB16	11-523
11.149	SXTH	11-524
11.150	SYS	11-526
11.151	TBB and TBH	11-527
11.152	TEQ	11-528
11.153	TST	11-530
11.154	UADD8	11-531
11.155	UADD16	11-532
11.156	UASX	11-533
11.157	UBFX	11-535
11.158	UDIV	11-536
11.159	UHADD8	11-537
11.160	UHADD16	11-538
11.161	UHASX	11-539
11.162	UHSAX	11-540
11.163	UHSUB8	11-541
11.164	UHSUB16	11-542
11.165	UMAAL	11-543
11.166	UMLAL	11-544
11.167	UMULL	11-545
11.168	UND pseudo-instruction	11-546
11.169	UQADD8	11-547
11.170	UQADD16	11-548
11.171	UQASX	11-549
11.172	UQSAX	11-550

11.173	<i>UQSUB8</i>	11-551
11.174	<i>UQSUB16</i>	11-552
11.175	<i>USAD8</i>	11-553
11.176	<i>USADA8</i>	11-554
11.177	<i>USAT</i>	11-555
11.178	<i>USAT16</i>	11-556
11.179	<i>USAX</i>	11-557
11.180	<i>USUB8</i>	11-559
11.181	<i>USUB16</i>	11-560
11.182	<i>UXTAB</i>	11-561
11.183	<i>UXTAB16</i>	11-562
11.184	<i>UXTAH</i>	11-564
11.185	<i>UXTB</i>	11-565
11.186	<i>UXTB16</i>	11-566
11.187	<i>UXTH</i>	11-567
11.188	<i>WFE</i>	11-568
11.189	<i>WFI</i>	11-569
11.190	<i>YIELD</i>	11-570

Chapter 12

NEON Instructions

12.1	<i>Summary of NEON instructions</i>	12-574
12.2	<i>Summary of shared NEON and VFP instructions</i>	12-578
12.3	<i>Interleaving provided by load and store element and structure instructions</i>	12-579
12.4	<i>Alignment restrictions in load and store element and structure instructions</i>	12-580
12.5	<i>VABA and VABAL</i>	12-581
12.6	<i>VABD and VABDL</i>	12-582
12.7	<i>VABS</i>	12-583
12.8	<i>VACLE, VACLT, VACGE and VACGT</i>	12-584
12.9	<i>VADD</i>	12-585
12.10	<i>VADDHN</i>	12-586
12.11	<i>VADDL and VADDW</i>	12-587
12.12	<i>VAND (immediate)</i>	12-588
12.13	<i>VAND (register)</i>	12-589
12.14	<i>VBIC (immediate)</i>	12-590
12.15	<i>VBIC (register)</i>	12-591
12.16	<i>VBIF</i>	12-592
12.17	<i>VBIT</i>	12-593
12.18	<i>VBSL</i>	12-594
12.19	<i>VCEQ (immediate #0)</i>	12-595
12.20	<i>VCEQ (register)</i>	12-596
12.21	<i>VCGE (immediate #0)</i>	12-597
12.22	<i>VCGE (register)</i>	12-598
12.23	<i>VCGT (immediate #0)</i>	12-599
12.24	<i>VCGT (register)</i>	12-600
12.25	<i>VCLE (immediate #0)</i>	12-601
12.26	<i>VCLE (register)</i>	12-602
12.27	<i>VCLS</i>	12-603
12.28	<i>VCLT (immediate #0)</i>	12-604
12.29	<i>VCLT (register)</i>	12-605
12.30	<i>VCLZ</i>	12-606

12.31	VCNT	12-607
12.32	VCVT (between fixed-point or integer, and floating-point)	12-608
12.33	VCVT (between half-precision and single-precision floating-point)	12-609
12.34	VDUP	12-610
12.35	VEOR	12-611
12.36	VEXT	12-612
12.37	VFMA, VFMS	12-613
12.38	VHADD	12-614
12.39	VHSUB	12-615
12.40	VLDn (single n-element structure to one lane)	12-616
12.41	VLDn (single n-element structure to all lanes)	12-618
12.42	VLDn (multiple n-element structures)	12-620
12.43	VLDM	12-622
12.44	VLDR	12-623
12.45	VLDR (post-increment and pre-decrement)	12-624
12.46	VLDR pseudo-instruction	12-625
12.47	VMAX and VMIN	12-626
12.48	VMLA	12-627
12.49	VMLA (by scalar)	12-628
12.50	VMLAL (by scalar)	12-629
12.51	VMLAL	12-630
12.52	VMLS (by scalar)	12-631
12.53	VMLS	12-632
12.54	VMLSL	12-633
12.55	VMLSL (by scalar)	12-634
12.56	VMOV (floating-point)	12-635
12.57	VMOV (immediate)	12-636
12.58	VMOV (register)	12-637
12.59	VMOV (between two ARM registers and a 64-bit extension register)	12-638
12.60	VMOV (between an ARM register and a NEON scalar)	12-639
12.61	VMOVL	12-640
12.62	VMOVN	12-641
12.63	VMOV2	12-642
12.64	VMRS	12-643
12.65	VMSR	12-644
12.66	VMUL	12-645
12.67	VMUL (by scalar)	12-646
12.68	VMULL	12-647
12.69	VMULL (by scalar)	12-648
12.70	VMVN (register)	12-649
12.71	VMVN (immediate)	12-650
12.72	VNEG	12-651
12.73	VORN (register)	12-652
12.74	VORN (immediate)	12-653
12.75	VORR (register)	12-654
12.76	VORR (immediate)	12-655
12.77	VPADAL	12-656
12.78	VPADD	12-657
12.79	VPADDL	12-658
12.80	VPMAX and VPMIN	12-659

12.81	VPOP	12-660
12.82	VPUSH	12-661
12.83	VQABS	12-662
12.84	VQADD	12-663
12.85	VQDMLAL and VQDMLSL (by vector or by scalar)	12-664
12.86	VQDMULH (by vector or by scalar)	12-665
12.87	VQDMULL (by vector or by scalar)	12-666
12.88	VQMOVN and VQMOVUN	12-667
12.89	VQNEG	12-668
12.90	VQRDMULH (by vector or by scalar)	12-669
12.91	VQRSHL (by signed variable)	12-670
12.92	VQRSHRN and VQRSHRUN (by immediate)	12-671
12.93	VQSHL (by signed variable)	12-672
12.94	VQSHL and VQSHLU (by immediate)	12-673
12.95	VQSHRN and VQSHRUN (by immediate)	12-674
12.96	VQSUB	12-675
12.97	VRADDHN	12-676
12.98	VRECPE	12-677
12.99	VRECPS	12-678
12.100	VREV16, VREV32, and VREV64	12-679
12.101	VRHADD	12-680
12.102	VRSHL (by signed variable)	12-681
12.103	VRSHR (by immediate)	12-682
12.104	VRSHRN (by immediate)	12-683
12.105	VRSQRTE	12-684
12.106	VRSQRTS	12-685
12.107	VRSRA (by immediate)	12-686
12.108	VRSUBHN	12-687
12.109	VSHL (by immediate)	12-688
12.110	VSHL (by signed variable)	12-689
12.111	VSHLL (by immediate)	12-690
12.112	VSHR (by immediate)	12-691
12.113	VSHRN (by immediate)	12-692
12.114	VSLI	12-693
12.115	VSRA (by immediate)	12-694
12.116	VSRI	12-695
12.117	VSTM	12-696
12.118	VSTn (multiple n-element structures)	12-697
12.119	VSTn (single n-element structure to one lane)	12-699
12.120	VSTR	12-701
12.121	VSTR (post-increment and pre-decrement)	12-702
12.122	VSUB	12-703
12.123	VSUBHN	12-704
12.124	VSUBL and VSUBW	12-705
12.125	VSWP	12-706
12.126	VTBL and VTBX	12-707
12.127	VTRN	12-708
12.128	VTST	12-709
12.129	VUZP	12-710
12.130	VZIP	12-711

Chapter 13

VFP Instructions

13.1	Summary of VFP instructions	13-714
13.2	VABS (floating-point)	13-716
13.3	VADD (floating-point)	13-717
13.4	VCMP, VCMPE	13-718
13.5	VCVT (between single-precision and double-precision)	13-719
13.6	VCVT (between floating-point and integer)	13-720
13.7	VCVT (between floating-point and fixed-point)	13-721
13.8	VCVTB, VCVTT (half-precision extension)	13-722
13.9	VDIV	13-723
13.10	VFMA, VFMS, VFNMA, VFNMS (floating-point)	13-724
13.11	VLDM (floating-point)	13-725
13.12	VLDR (floating-point)	13-726
13.13	VLDR (post-increment and pre-decrement, floating-point)	13-727
13.14	VLDR pseudo-instruction	13-728
13.15	VMLA (floating-point)	13-729
13.16	VMLS (floating-point)	13-730
13.17	VMOV (floating-point)	13-731
13.18	VMOV (between one ARM register and single precision VFP)	13-732
13.19	VMOV (between two ARM registers and one or two extension registers)	13-733
13.20	VMOV (between an ARM register and half a double precision VFP register) ...	13-734
13.21	VMRS	13-735
13.22	VMSR	13-736
13.23	VMUL (floating-point)	13-737
13.24	VNEG (floating-point)	13-738
13.25	VNMLA (floating-point)	13-739
13.26	VNMLS (floating-point)	13-740
13.27	VNMUL (floating-point)	13-741
13.28	VPOP (floating-point)	13-742
13.29	VPUSH (floating-point)	13-743
13.30	VSQRT	13-744
13.31	VSTM (floating-point)	13-745
13.32	VSTR (floating-point)	13-746
13.33	VSTR (post-increment and pre-decrement, floating-point)	13-747
13.34	VSUB (floating-point)	13-748

Chapter 14

Wireless MMX Technology Instructions

14.1	About Wireless MMX Technology instructions	14-750
14.2	WRN and WCN directives to support Wireless MMX Technology	14-751
14.3	Frame directives and Wireless MMX Technology	14-752
14.4	Wireless MMX load and store instructions	14-753
14.5	Wireless MMX Technology and XScale instructions	14-755
14.6	Wireless MMX instructions	14-756
14.7	Wireless MMX pseudo-instructions	14-758

Chapter 15

Directives Reference

15.1	Alphabetical list of directives	15-761
15.2	About assembly control directives	15-762
15.3	About frame directives	15-763
15.4	ALIAS	15-764

15.5	ALIGN	15-765
15.6	AREA	15-767
15.7	ARM or CODE32	15-770
15.8	ASSERT	15-771
15.9	ATTR	15-772
15.10	CN	15-773
15.11	CODE16	15-774
15.12	COMMON	15-775
15.13	CP	15-776
15.14	DATA	15-777
15.15	DCB	15-778
15.16	DCD and DCDU	15-779
15.17	DCDO	15-780
15.18	DCFD and DCFDU	15-781
15.19	DCFS and DCFSU	15-782
15.20	DCI	15-783
15.21	DCQ and DCQU	15-784
15.22	DCW and DCWU	15-785
15.23	END	15-786
15.24	ENDFUNC or ENDP	15-787
15.25	ENTRY	15-788
15.26	EQU	15-789
15.27	EXPORT or GLOBAL	15-790
15.28	EXPORTAS	15-792
15.29	FIELD	15-793
15.30	FRAME ADDRESS	15-794
15.31	FRAME POP	15-795
15.32	FRAME PUSH	15-796
15.33	FRAME REGISTER	15-797
15.34	FRAME RESTORE	15-798
15.35	FRAME RETURN ADDRESS	15-799
15.36	FRAME SAVE	15-800
15.37	FRAME STATE REMEMBER	15-801
15.38	FRAME STATE RESTORE	15-802
15.39	FRAME UNWIND ON	15-803
15.40	FRAME UNWIND OFF	15-804
15.41	FUNCTION or PROC	15-805
15.42	GBLA, GBLL, and GBLS	15-806
15.43	GET or INCLUDE	15-807
15.44	IF, ELSE, ENDIF, and ELIF	15-808
15.45	IMPORT and EXTERN	15-810
15.46	INCBIN	15-812
15.47	INFO	15-813
15.48	KEEP	15-814
15.49	LCLA, LCLL, and LCLS	15-815
15.50	LTORG	15-816
15.51	MACRO and MEND	15-817
15.52	MAP	15-820
15.53	MEXIT	15-821
15.54	NOFP	15-822

15.55	<i>OPT</i>	15-823
15.56	<i>QN, DN, and SN</i>	15-825
15.57	<i>RELOC</i>	15-827
15.58	<i>REQUIRE</i>	15-828
15.59	<i>REQUIRE8 and PRESERVE8</i>	15-829
15.60	<i>RLIST</i>	15-830
15.61	<i>RN</i>	15-831
15.62	<i>ROUT</i>	15-832
15.63	<i>SETA, SETL, and SETS</i>	15-833
15.64	<i>SPACE or FILL</i>	15-834
15.65	<i>THUMB</i>	15-835
15.66	<i>THUMBX</i>	15-836
15.67	<i>TTL and SUBT</i>	15-837
15.68	<i>WHILE and WEND</i>	15-838

Chapter 16

Via File Syntax

16.1	<i>Overview of via files</i>	16-840
16.2	<i>Via file syntax rules</i>	16-841

Appendix A

Assembler Document Revisions

A.1	<i>Revisions for armasm User Guide</i>	Appx-A-843
-----	--	------------

List of Figures

ARM® Compiler armasm User Guide

Figure 2-1	Organization of general-purpose registers and Program Status Registers	2-43
Figure 8-1	NEON extension register bank	8-171
Figure 9-1	VFP extension register bank	9-194
Figure 9-2	VFPv2 register banks	9-208
Figure 9-3	VFPv3 register banks	9-208
Figure 11-1	ASR #3	11-315
Figure 11-2	LSR #3	11-316
Figure 11-3	LSL #3	11-316
Figure 11-4	ROR #3	11-316
Figure 11-5	RRX	11-317
Figure 12-1	De-interleaving an array of 3-element structures	12-579
Figure 12-2	Operation of doubleword VEXT for imm = 3	12-612
Figure 12-3	Example of operation of VPADAL (in this case for data type S16)	12-656
Figure 12-4	Example of operation of VPADD (in this case, for data type I16)	12-657
Figure 12-5	Example of operation of doubleword VPADDL (in this case, for data type S16)	12-658
Figure 12-6	Operation of quadword VSHL.I64 Qd, Qm, #1	12-688
Figure 12-7	Operation of quadword VSLLI.64 Qd, Qm, #1	12-693
Figure 12-8	Operation of doubleword VSRI.64 Dd, Dm, #2	12-695
Figure 12-9	Operation of doubleword VTRN.8	12-708
Figure 12-10	Operation of doubleword VTRN.32	12-708

List of Tables

ARM® Compiler armasm User Guide

Table 2-1	ARM processor modes	2-38
Table 2-2	Predeclared core registers	2-46
Table 2-3	Predeclared extension registers	2-47
Table 2-4	Predeclared XScale registers	2-48
Table 2-5	Predeclared Wireless MMX registers	2-48
Table 2-6	Predeclared coprocessor registers	2-49
Table 2-7	Instruction groups	2-55
Table 4-1	Stack-oriented suffixes and equivalent addressing mode suffixes	4-82
Table 4-2	Suffixes for load and store multiple instructions	4-82
Table 4-3	Changes from earlier ARM assembly language	4-99
Table 4-4	Relaxation of requirements	4-99
Table 4-5	Differences between pre-UAL Thumb syntax and UAL syntax	4-100
Table 5-1	Condition code suffixes and related flags	5-106
Table 5-2	Condition codes	5-107
Table 5-3	Conditional branches only	5-110
Table 5-4	All instructions conditional	5-111
Table 6-1	Built-in variables	6-118
Table 6-2	Built-in Boolean constants	6-119
Table 6-3	Predefined macros	6-119
Table 6-4	{TARGET_ARCH_ARM} in relation to {TARGET_ARCH_THUMB}	6-120
Table 6-5	Command-line options	6-132
Table 6-6	armcc equivalent command-line options	6-132
Table 7-1	Unary operators that return strings	7-156

Table 7-2	Unary operators that return numeric or logical values	7-156
Table 7-3	Multiplicative operators	7-158
Table 7-4	String manipulation operators	7-159
Table 7-5	Shift operators	7-160
Table 7-6	Addition, subtraction, and logical operators	7-161
Table 7-7	Relational operators	7-162
Table 7-8	Boolean operators	7-163
Table 7-9	Operator precedence in ARM assembly language	7-165
Table 7-10	Operator precedence in C	7-165
Table 8-1	NEON data type specifiers	8-177
Table 8-2	NEON saturation ranges	8-181
Table 9-1	VFP data type specifiers	9-200
Table 9-2	Pre-UAL VFP mnemonics	9-215
Table 9-3	Floating-point values for use with FCONST	9-216
Table 10-1	Compatible processor or architecture combinations	10-234
Table 10-2	Supported ARM architectures	10-238
Table 10-3	Severity of diagnostic messages	10-244
Table 10-4	Specifying a command-line option and an AREA directive for GNU-stack sections	10-253
Table 11-1	Summary of ARM and Thumb instructions	11-303
Table 11-2	Condition code suffixes	11-319
Table 11-3	PC-relative offsets	11-325
Table 11-4	Register-relative offsets	11-327
Table 11-5	B instruction availability and range	11-335
Table 11-6	BL instruction availability and range	11-342
Table 11-7	BLX instruction availability and range	11-344
Table 11-8	BX instruction availability and range	11-346
Table 11-9	BXJ instruction availability and range	11-348
Table 11-10	Offsets and architectures, LDR, word, halfword, and byte	11-374
Table 11-11	PC-relative offsets	11-378
Table 11-12	Options and architectures, LDR (register offsets)	11-381
Table 11-13	Register-relative offsets	11-383
Table 11-14	Offsets and architectures, LDR (User mode)	11-388
Table 11-15	Offsets and architectures, STR, word, halfword, and byte	11-503
Table 11-16	Options and architectures, STR (register offsets)	11-506
Table 11-17	Offsets and architectures, STR (User mode)	11-509
Table 11-18	Range and encoding of expr	11-546
Table 12-1	Summary of NEON instructions	12-574
Table 12-2	Summary of shared NEON and VFP instructions	12-578
Table 12-3	Patterns for immediate value in VBIC (immediate)	12-590
Table 12-4	Permitted combinations of parameters for VLDn (single n-element structure to one lane)	12-616
Table 12-5	Permitted combinations of parameters for VLDn (single n-element structure to all lanes)	12-618
Table 12-6	Permitted combinations of parameters for VLDn (multiple n-element structures)	12-620
Table 12-7	Available immediate values in VMOV (immediate)	12-636
Table 12-8	Available immediate values in VMVN (immediate)	12-650
Table 12-9	Patterns for immediate value in VORR (immediate)	12-655
Table 12-10	Available immediate ranges in VQRSHRN and VQRSHRUN (by immediate)	12-671
Table 12-11	Available immediate ranges in VQSHL and VQSHLU (by immediate)	12-673
Table 12-12	Available immediate ranges in VQSHRN and VQSHRUN (by immediate)	12-674

Table 12-13	Results for out-of-range inputs in VRECPE	12-677
Table 12-14	Results for out-of-range inputs in VRECPS	12-678
Table 12-15	Available immediate ranges in VRSHR (by immediate)	12-682
Table 12-16	Available immediate ranges in VRSHRN (by immediate)	12-683
Table 12-17	Results for out-of-range inputs in VRSQRTE	12-684
Table 12-18	Results for out-of-range inputs in VRSQRTS	12-685
Table 12-19	Available immediate ranges in VRSRA (by immediate)	12-686
Table 12-20	Available immediate ranges in VSHL (by immediate)	12-688
Table 12-21	Available immediate ranges in VSHLL (by immediate)	12-690
Table 12-22	Available immediate ranges in VSHR (by immediate)	12-691
Table 12-23	Available immediate ranges in VSHRN (by immediate)	12-692
Table 12-24	Available immediate ranges in VSRA (by immediate)	12-694
Table 12-25	Permitted combinations of parameters for VSTn (multiple n-element structures)	12-697
Table 12-26	Permitted combinations of parameters for VSTn (single n-element structure to one lane)	12-699
Table 12-27	Operation of doubleword VUZP.8	12-710
Table 12-28	Operation of quadword VUZP.32	12-710
Table 12-29	Operation of doubleword VZIP.8	12-711
Table 12-30	Operation of quadword VZIP.32	12-711
Table 13-1	Summary of VFP instructions	13-714
Table 14-1	Wireless MMX Technology instructions	14-756
Table 14-2	Wireless MMX Technology pseudo-instructions	14-758
Table 15-1	List of directives	15-761
Table 15-2	OPT directive settings	15-823
Table A-1	Differences between issue L and issue M	Appx-A-843
Table A-2	Differences between issue K and issue L	Appx-A-843
Table A-3	Differences between issue J and issue K	Appx-A-844
Table A-4	Differences between issue I and issue J	Appx-A-845
Table A-5	Differences between issue H and issue I	Appx-A-845
Table A-6	Differences between issue G and issue H	Appx-A-846
Table A-7	Differences between issue F and issue G	Appx-A-847
Table A-8	Differences between issue E and issue F	Appx-A-847
Table A-9	Differences between issue D and issue E	Appx-A-848
Table A-10	Differences between issue C and issue D	Appx-A-848
Table A-11	Differences between issue B and issue C	Appx-A-848
Table A-12	Differences between issue A and issue B	Appx-A-849

Preface

This preface introduces the *ARM® Compiler armasm User Guide*.

It contains the following:

- [About this book on page 24.](#)

About this book

The ARM® Compiler armasm User Guide provides user information for the ARM assembler, armasm. It contains information on command-line options, instruction sets, and assembler directives.

Using this book

This book is organized into the following chapters:

Chapter 1 Overview of the Assembler

Gives an overview of the assemblers provided with ARM® Compiler toolchain.

Chapter 2 Overview of the ARM Architecture

Gives an overview of the ARM architecture.

Chapter 3 Structure of Assembly Language Modules

Describes the structure of assembly language source files.

Chapter 4 Writing ARM Assembly Language

Describes the use of a few basic assembly language instructions and the use of macros.

Chapter 5 Condition Codes

Describes condition codes and the conditional execution of ARM and Thumb code.

Chapter 6 Using the Assembler

Describes how to use the ARM assembler, armasm.

Chapter 7 Symbols, Literals, Expressions, and Operators

Describes how you can use symbols to represent variables, addresses, and constants in code, and how you can combine these with operators to create numeric or string expressions.

Chapter 8 NEON Programming

Describes the assembly programming of NEON hardware.

Chapter 9 VFP Programming

Describes the assembly programming of VFP hardware.

Chapter 10 Assembler Command-line Options

Describes the command-line options supported by the ARM assembler, armasm.

Chapter 11 ARM and Thumb Instructions

Describes the ARM and Thumb instructions supported by the ARM assembler, armasm.

Chapter 12 NEON Instructions

Describes the assembly programming of NEON technology.

Chapter 13 VFP Instructions

Describes the assembly programming of the VFP hardware.

Chapter 14 Wireless MMX Technology Instructions

Describes the support for Wireless MMX Technology instructions.

Chapter 15 Directives Reference

Describes the directives that are provided by the ARM assembler, armasm.

Chapter 16 Via File Syntax

Describes the syntax of via files accepted by armasm.

Appendix A Assembler Document Revisions

Describes the technical changes that have been made to the armasm User Guide.

Glossary

The ARM Glossary is a list of terms used in ARM documentation, together with definitions for those terms. The ARM Glossary does not contain terms that are industry standard unless the ARM meaning differs from the generally accepted meaning.

See the [ARM Glossary](#) for more information.

Typographic conventions

italic

Introduces special terminology, denotes cross-references, and citations.

bold

Highlights interface elements, such as menu names. Denotes signal names. Also used for terms in descriptive lists, where appropriate.

monospace

Denotes text that you can enter at the keyboard, such as commands, file and program names, and source code.

monospace

Denotes a permitted abbreviation for a command or option. You can enter the underlined text instead of the full command or option name.

monospace italic

Denotes arguments to monospace text where the argument is to be replaced by a specific value.

monospace bold

Denotes language keywords when used outside example code.

<and>

Encloses replaceable terms for assembler syntax where they appear in code or code fragments. For example:

```
MRC p15, 0, <Rd>, <CRn>, <CRm>, <Opcode_2>
```

SMALL CAPITALS

Used in body text for a few terms that have specific technical meanings, that are defined in the *ARM glossary*. For example, IMPLEMENTATION DEFINED, IMPLEMENTATION SPECIFIC, UNKNOWN, and UNPREDICTABLE.

Feedback

Feedback on this product

If you have any comments or suggestions about this product, contact your supplier and give:

- The product name.
- The product revision or version.
- An explanation with as much information as you can provide. Include symptoms and diagnostic procedures if appropriate.

Feedback on content

If you have comments on content then send an e-mail to errata@arm.com. Give:

- The title *ARM® Compiler armasm User Guide*.
- The number ARM DUI0473M.
- If applicable, the page number(s) to which your comments refer.
- A concise explanation of your comments.

ARM also welcomes general suggestions for additions and improvements.

————— Note —————

ARM tests the PDF only in Adobe Acrobat and Acrobat Reader, and cannot guarantee the quality of the represented document when used with any other PDF reader.

Other information

- [ARM Information Center](#).
- [ARM Technical Support Knowledge Articles](#).

- *Support and Maintenance.*
- *ARM Glossary.*

Chapter 1

Overview of the Assembler

Gives an overview of the assemblers provided with ARM® Compiler toolchain.

It contains the following sections:

- *1.1 About the ARM Compiler toolchain assemblers on page 1-28.*
- *1.2 Key features of the assembler on page 1-29.*
- *1.3 How the assembler works on page 1-30.*
- *1.4 Directives that can be omitted in pass 2 of the assembler on page 1-32.*

1.1 About the ARM Compiler toolchain assemblers

The ARM Compiler toolchain provides different assemblers.

They are:

- A freestanding assembler, `armasm`.
- An optimizing inline assembler and a non-optimizing embedded assembler built into the C and C++ compilers. These use the same syntax for assembly instructions.

Note

Be aware of the following:

- Generated code might be different between two ARM Compiler releases.
- For a feature release, there might be significant code generation differences.

Note

The command-line option descriptions and related information in the individual ARM Compiler tools documents describe all the features that ARM Compiler supports. Any features not documented are not supported and are used at your own risk. You are responsible for making sure that any generated code using unsupported features is operating correctly.

Related information

Mixing C, C++, and Assembly Language.

Using the Inline and Embedded Assemblers of the ARM Compiler.

Migrating from RVCT v4.0 to ARM Compiler v4.1.

Migrating from RVCT v3.1 to RVCT v4.0.

1.2 Key features of the assembler

The ARM assembler supports instructions, directives, and user-defined macros.

It supports:

- *Unified Assembly Language* (UAL) for both ARM and Thumb® code.
- NEON™ *Single Instruction Multiple Data* (SIMD) instructions in ARM and Thumb code.
- *Vector Floating Point* (VFP) instructions in ARM and Thumb code.
- Wireless MMX Technology instructions to assemble code to run on the PXA270 processor.
- Directives in assembly source code.
- Processing of user-defined macros.

Related concepts

[1.3 How the assembler works](#) on page 1-30.

[4.1 About the Unified Assembler Language](#) on page 4-65.

[2.6 NEON technology](#) on page 2-40.

[4.21 Use of macros](#) on page 4-90.

[8.1 Architecture support for NEON](#) on page 8-168.

Related references

[Chapter 8 NEON Programming](#) on page 8-167.

[Chapter 14 Wireless MMX Technology Instructions](#) on page 14-749.

[Chapter 15 Directives Reference](#) on page 15-759.

1.3 How the assembler works

The ARM assembler reads the assembly language source code twice before it outputs object code. Each read of the source code is called a pass.

This is because assembly language source code often contains forward references. A forward reference occurs when a label is used as an operand, for example as a branch target, earlier in the code than the definition of the label. The assembler cannot know the address of the forward reference label until it reads the definition of the label.

During each pass, the assembler performs different functions. In the first pass, the assembler:

- Checks the syntax of the instruction or directive. It faults if there is an error in the syntax, for example if a label is specified on a directive that does not accept one.
- Determines the size of the instruction and data being assembled and reserves space.
- Determines offsets of labels within sections.
- Creates a symbol table containing label definitions and their memory addresses.

In the second pass, the assembler:

- Faults if an undefined reference is specified in an instruction operand or directive.
- Encodes the instructions using the label offsets from pass 1, where applicable.
- Generates relocations.
- Generates debug information if requested.
- Outputs the object file.

Memory addresses of labels are determined and finalized in the first pass. Therefore, the assembly code must not change during the second pass. All instructions must be seen in both passes. Therefore you must not define a symbol after a `:DEF:` test for the symbol. The assembler faults if it sees code in pass 2 that was not seen in pass 1.

Line not seen in pass 1

The following example shows that `num EQU 42` is not seen in pass 1 but is seen in pass 2:

```

AREA x, CODE
[ :DEF: foo
num EQU 42
]
foo DCD num
END

```

Assembling this code generates the error:

```
A1903E: Line not seen in first pass; cannot be assembled.
```

Line not seen in pass 2

The following example shows that `MOV r1, r2` is seen in pass 1 but not in pass 2:

```

AREA x, CODE
[ :LNOT: :DEF: foo
MOV r1, r2
]
foo MOV r3, r4
END

```

Assembling this code generates the error:

```
A1909E: Line not seen in second pass; cannot be assembled.
```

Related concepts

[6.13 Two pass assembler diagnostics on page 6-130.](#)

[4.24 Instruction and directive relocations on page 4-94.](#)

Related references

1.4 Directives that can be omitted in pass 2 of the assembler on page 1-32.

10.19 --diag_error=tag[,tag,...] on page 10-244.

10.16 --debug on page 10-241.

1.4 Directives that can be omitted in pass 2 of the assembler

Most directives must appear in both passes of the assembly process. You can omit some directives from the second pass over the source code by the assembler, but doing this is strongly discouraged.

Directives that can be omitted from pass 2 are:

- GBLA, GBLL, GBLS.
- LCLA, LCLL, LCLS.
- SETA, SETL, SETS.
- RN, RLIST.
- CN, CP.
- SN, DN, QN.
- EQU.
- MAP, FIELD.
- GET, INCLUDE.
- IF, ELSE, ELIF, ENDIF.
- WHILE, WEND.
- ASSERT.
- ATTR.
- COMMON.
- EXPORTAS.
- IMPORT.
- EXTERN.
- KEEP.
- MACRO, MEND, MEXIT.
- REQUIRE8.
- PRESERVE8.

Note

Macros that appear only in pass 1 and not in pass 2 must contain only these directives.

ASSERT directive appears in pass 1 only

The code in the following example assembles without error although the ASSERT directive does not appear in pass 2:

```
x AREA ||.text||,CODE
  EQU 42
  IF :LNOT: :DEF: sym
    ASSERT x == 42
  ENDIF
sym EQU 1
END
```

Use of ELSE and ELIF directives

Directives that appear in pass 2 but do not appear in pass 1 cause an assembly error. However, this does not cause an assembly error when using the ELSE and ELIF directives if their matching IF directive appears in pass 1. The following example assembles without error because the IF directive appears in pass 1:

```
x AREA ||.text||,CODE
  EQU 42
  IF :DEF: sym
    ELSE
      ASSERT x == 42
    ENDIF
sym EQU 1
END
```

Related concepts

1.3 How the assembler works on page 1-30.

6.13 Two pass assembler diagnostics on page 6-130.

Chapter 2

Overview of the ARM Architecture

Gives an overview of the ARM architecture.

It contains the following sections:

- [2.1 About the ARM architecture](#) on page 2-35.
- [2.2 ARM, Thumb, and ThumbEE instruction sets](#) on page 2-36.
- [2.3 Changing between ARM, Thumb, and ThumbEE state](#) on page 2-37.
- [2.4 Processor modes, and privileged and unprivileged software execution](#) on page 2-38.
- [2.5 Processor modes in ARMv6-M and ARMv7-M](#) on page 2-39.
- [2.6 NEON technology](#) on page 2-40.
- [2.7 VFP hardware](#) on page 2-41.
- [2.8 ARM registers](#) on page 2-42.
- [2.9 General-purpose registers](#) on page 2-44.
- [2.10 Register accesses](#) on page 2-45.
- [2.11 Predeclared core register names](#) on page 2-46.
- [2.12 Predeclared extension register names](#) on page 2-47.
- [2.13 Predeclared XScale register names](#) on page 2-48.
- [2.14 Predeclared coprocessor names](#) on page 2-49.
- [2.15 Program Counter](#) on page 2-50.
- [2.16 Application Program Status Register](#) on page 2-51.
- [2.17 The Q flag](#) on page 2-52.
- [2.18 Current Program Status Register](#) on page 2-53.
- [2.19 Saved Program Status Registers](#) on page 2-54.
- [2.20 ARM and Thumb instruction set overview](#) on page 2-55.
- [2.21 Access to the inline barrel shifter](#) on page 2-56.

2.1 About the ARM architecture

The ARM architecture is a load-store architecture, with a 32-bit addressing range.

ARM processors are typical of RISC processors in that only load and store instructions can access memory. Data processing instructions operate on register contents only.

It is assumed that you are using a processor that implements the ARMv4 or later architecture. All these processors have a 32-bit addressing range.

Related information

[ARM Architecture Reference Manual.](#)

2.2 ARM, Thumb, and ThumbEE instruction sets

ARM instructions are 32 bits wide. Thumb instructions are 16 or 32-bits wide.

The ARM instruction set is a set of 32-bit instructions providing a comprehensive range of operations.

ARMv4T and later define a 16-bit instruction set called Thumb. Most of the functionality of the 32-bit ARM instruction set is available, but some operations require more instructions. The Thumb instruction set provides better code density, at the expense of performance.

ARMv6T2 introduces Thumb-2 technology. This is a major enhancement to the Thumb instruction set by providing 32-bit Thumb instructions. The 32-bit and 16-bit Thumb instructions together provide almost exactly the same functionality as the ARM instruction set. This version of the Thumb instruction set achieves the high performance of ARM code along with the benefits of better code density.

ARMv7 includes Thumb-2 technology. ARMv7-M only supports the Thumb instruction set. Therefore, interworking instructions in ARMv7-M must not attempt to change to ARM state. ARMv7-A and ARMv7-R support both ARM and Thumb instruction sets.

ARMv7 defines the *Thumb Execution Environment* (ThumbEE). The ThumbEE instruction set is based on Thumb, with some changes and additions to make it a better target for dynamically generated code, that is, code compiled on the device either shortly before or during execution.

————— **Note** —————

ARM deprecates the use of ThumbEE instructions.

—————

Related references

[2.20 ARM and Thumb instruction set overview on page 2-55.](#)

2.3 Changing between ARM, Thumb, and ThumbEE state

The processor must be in the correct *instruction set state* for the instructions it is executing.

A processor that is executing ARM instructions is operating in *ARM state*. A processor that is executing Thumb instructions is operating in *Thumb state*. A processor that is executing ThumbEE instructions is operating in *ThumbEE state*. A processor can also operate in another state called the *Jazelle® state*. These are called *instruction set states*. The assembler cannot directly assemble code for the Jazelle state.

A processor in one instruction set state cannot execute instructions from another instruction set. For example, a processor in ARM state cannot execute Thumb instructions, and a processor in Thumb state cannot execute ARM instructions. You must ensure that the processor never receives instructions of the wrong instruction set for the current state.

The initial state after reset depends on the processor being used and its configuration.

To direct the assembler to generate ARM or Thumb instruction encodings, you must set the assembler mode using an `ARM` or `THUMB` directive. To generate ThumbEE code, use the `THUMBX` directive. Assembly code using `CODE32` and `CODE16` directives can still be assembled, but ARM recommends using `ARM` and `THUMB` for new code.

These directives do not change the instruction set state of the processor. To do this, you must use an appropriate instruction, for example `BX` or `BLX` to change between ARM and Thumb states when performing a branch.

Related references

[11.22 BLX on page 11-344.](#)

[11.23 BX on page 11-346.](#)

[15.7 ARM or CODE32 on page 15-770.](#)

[15.65 THUMB on page 15-835.](#)

[15.66 THUMBX on page 15-836.](#)

2.4 Processor modes, and privileged and unprivileged software execution

The ARM architecture supports different levels of execution privilege. The privilege level depends on the processor mode.

————— **Note** —————

ARMv6-M and ARMv7-M do not support the same modes as other ARM architectures and profiles. Some of the processor modes listed here do not apply to ARMv6-M and ARMv7-M.

Table 2-1 ARM processor modes

Processor mode	Architectures	Mode number
User	All	0b10000
FIQ	All	0b10001
IRQ	All	0b10010
Supervisor	All	0b10011
Monitor	Security Extensions only	0b10110
Abort	All	0b10111
Hyp	Virtualization Extensions only	0b11010
Undefined	All	0b11011
System	ARMv4 and later	0b11111

User mode is an unprivileged mode, and has restricted access to system resources. All other modes have full access to system resources in the current security state, can change mode freely, and execute software as privileged.

Applications that require task protection usually execute in User mode. Some embedded applications might run entirely in any mode other than User mode. An application that requires full access to system resources usually executes in System mode.

Modes other than User mode are entered to service exceptions, or to access privileged resources.

On an implementation that includes the Security Extensions, in all modes except Monitor mode and Hypervisor (Hyp) mode, code can run in either a Secure state or in a Non-secure state. In Monitor mode, code can only run in a Secure state, and in Hyp mode, code can only run in a Non-secure state.

Related concepts

[2.5 Processor modes in ARMv6-M and ARMv7-M on page 2-39.](#)

Related information

[ARM Architecture Reference Manual.](#)

2.5 Processor modes in ARMv6-M and ARMv7-M

The processor modes available in ARMv6-M and ARMv7-M are Thread mode and Handler mode.

Thread mode is the normal mode that programs run in. Thread mode can be privileged or unprivileged software execution. Handler mode is the mode that exceptions are handled in. It is always privileged software execution.

Related concepts

[2.4 Processor modes, and privileged and unprivileged software execution on page 2-38.](#)

Related information

[ARM Architecture Reference Manual.](#)

2.6 NEON technology

ARM NEON technology is the implementation of the Advanced SIMD architecture extension. It is a 64 and 128-bit hybrid SIMD technology targeted at advanced media and signal processing applications and embedded processors.

NEON instructions are available in both ARM and Thumb code.

Note

Not all ARM processors support NEON technology. In particular, there is no NEON support for architectures before ARMv7.

Note

The NEON register bank is shared with the VFP register bank.

Related concepts

[8.1 Architecture support for NEON](#) on page 8-168.

[8.5 NEON views of the extension register bank](#) on page 8-173.

Related references

[Chapter 8 NEON Programming](#) on page 8-167.

Related information

[Using the NEON Vectorizing Compiler.](#)

2.7 VFP hardware

There are several VFP architecture versions and variants.

The VFP hardware, together with associated support code, provides single-precision and double-precision floating-point arithmetic, as defined by *ANSI/IEEE Std. 754-1985 IEEE Standard for Binary Floating-Point Arithmetic*. This document is referred to as the IEEE 754 standard.

The VFP hardware uses a register bank that is distinct from the ARM core register bank.

There are several versions of the VFP architecture, including VFPv2, VFPv3, VFPv3 with half precision extensions, and VFPv4. In addition, FPv5 is available for ARM Cortex[®]-M7 processors. There are variants of VFPv3 and VFPv4 that differ in the number of accessible registers or in their support for trapping floating-point exceptions.

Related concepts

[9.1 Architecture support for VFP on page 9-191.](#)

[9.2 Half-precision extension for VFP on page 9-192.](#)

[9.5 VFP views of the extension register bank on page 9-196.](#)

Related references

[Chapter 9 VFP Programming on page 9-189.](#)

Related information

[Vector Floating-Point \(VFP\) architectures.](#)

2.8 ARM registers

ARM processors provide general-purpose and special-purpose registers. Some additional registers are available in privileged execution modes.

In all ARM processors, the following registers are available and accessible in any processor mode:

- 13 general-purpose registers R0-R12.
- One *Stack Pointer* (SP).
- One *Link Register* (LR).
- One *Program Counter* (PC).
- One *Application Program Status Register* (APSR).

Note

The Link Register can also be used as a general-purpose register. The Stack Pointer can be used as a general-purpose register in ARM state only.

Additional registers are available in privileged software execution.

ARM processors, with the exception of ARMv6-M and ARMv7-M based processors, have a total of 37 registers, with 3 additional registers if the Security Extensions are implemented, and in ARMv7-A only, 3 more if the Virtualization Extensions are implemented. The registers are arranged in partially overlapping banks. There is a different register bank for each processor mode. The banked registers give rapid context switching for dealing with processor exceptions and privileged operations.

The additional registers that are available in privileged software execution, with the exception of ARMv6-M and ARMv7-M, are:

- Two Supervisor mode registers for banked SP and LR.
- Two Abort mode registers for banked SP and LR.
- Two Undefined mode registers for banked SP and LR.
- Two Interrupt mode registers for banked SP and LR.
- Seven FIQ mode registers for banked R8-R12, SP and LR.
- Two Monitor mode registers for banked SP and LR. These are only present if the Security Extensions are implemented.
- Two Hyp mode registers for banked SP, and to hold the return address from Hyp mode. These are only present if the Virtualization Extensions are implemented.
- One *Saved Program Status Register* (SPSR) for each exception mode.

Note

In privileged software execution, CPSR is an alias for APSR and gives access to additional bits.

The following figure shows how the registers are banked in the ARM architecture except ARMv6-M and ARMv7-M:

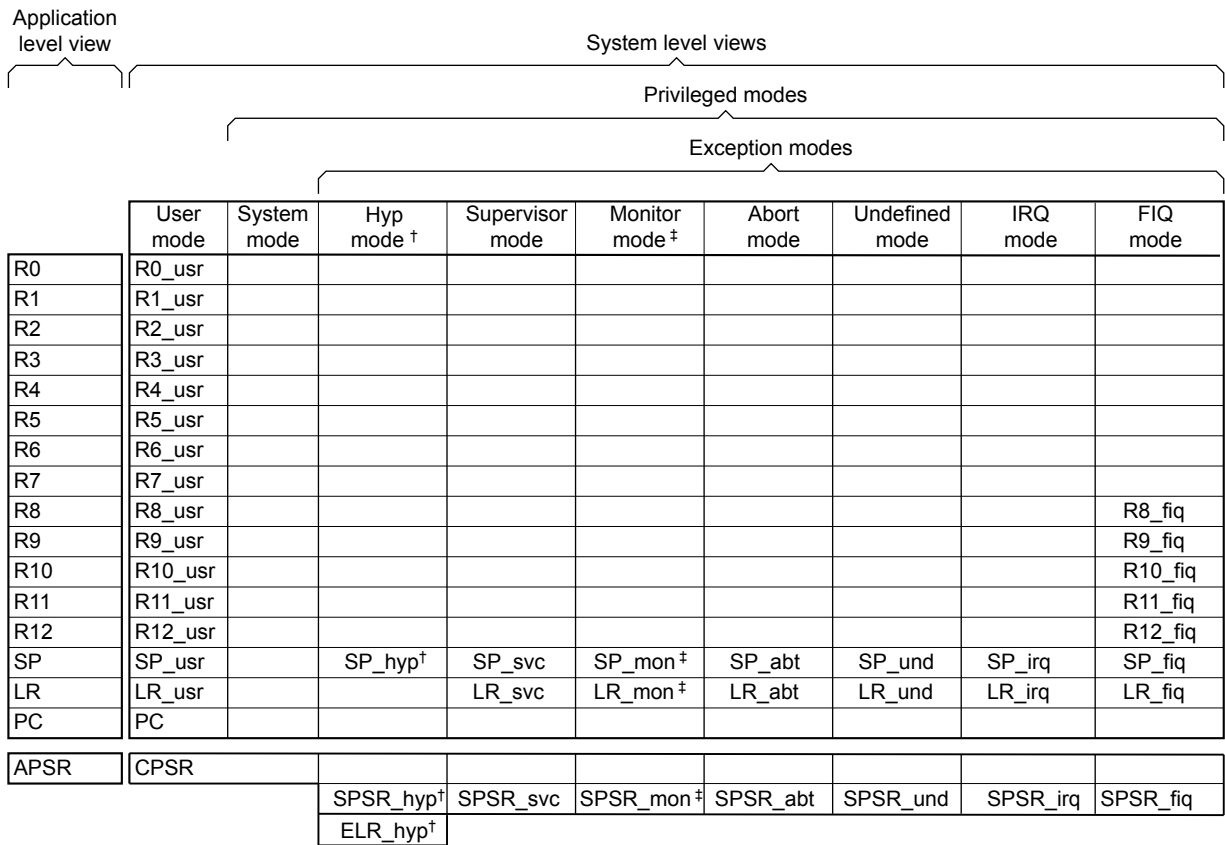

† Hyp mode and the associated banked registers are implemented only as part of the Virtualization Extensions

‡ Monitor mode and the associated banked registers are implemented only as part of the Security Extensions

Figure 2-1 Organization of general-purpose registers and Program Status Registers

In ARMv6-M and ARMv7-M based processors, SP is an alias for the two banked stack pointer registers:

- Main stack pointer register, which is only available in privileged software execution.
- Process stack pointer register.

Related concepts

[2.9 General-purpose registers on page 2-44.](#)

[2.15 Program Counter on page 2-50.](#)

[2.16 Application Program Status Register on page 2-51.](#)

[2.19 Saved Program Status Registers on page 2-54.](#)

[2.18 Current Program Status Register on page 2-53.](#)

[2.4 Processor modes, and privileged and unprivileged software execution on page 2-38.](#)

Related information

[ARM Architecture Reference Manual.](#)

2.9 General-purpose registers

There are restrictions on the use of SP and LR as general-purpose registers.

With the exception of ARMv6-M and ARMv7-M based processors, there are 30 (or 32 if Security Extensions are implemented) general-purpose 32-bit registers, that include the banked SP and LR registers. Fifteen general-purpose registers are visible at any one time, depending on the current processor mode. These are R0-R12, SP, LR. The PC (R15) is not considered a general-purpose register.

SP (or R13) is the *stack pointer*. The C and C++ compilers always use SP as the stack pointer. Use of SP as a general purpose register is discouraged. In Thumb, SP is strictly defined as the stack pointer. The instruction descriptions mention when SP and PC can be used.

In User mode, LR (or R14) is used as a *link register* to store the return address when a subroutine call is made. It can also be used as a general-purpose register if the return address is stored on the stack.

In the exception handling modes, LR holds the return address for the exception, or a subroutine return address if subroutine calls are executed within an exception. LR can be used as a general-purpose register if the return address is stored on the stack.

Note

When using the `--use_frame_pointer` option with `armcc`, do not use R11 as a general-purpose register.

Related concepts

[2.15 Program Counter](#) on page 2-50.

[2.10 Register accesses](#) on page 2-45.

Related references

[2.11 Predeclared core register names](#) on page 2-46.

[11.63 MRS \(PSR to general-purpose register\)](#) on page 11-410.

[11.66 MSR \(general-purpose register to PSR\)](#) on page 11-414.

Related information

[--use_frame_pointer \(compiler option\)](#).

2.10 Register accesses

16-bit Thumb instructions can access only a limited set of registers. There are also some restrictions on the use of special-purpose registers by ARM and 32-bit Thumb instructions.

Most 16-bit Thumb instructions can only access R0 to R7. Only a small number of these instructions can access R8-R12, SP, LR, and PC. Registers R0 to R7 are called Lo registers. Registers R8-R12, SP, LR, and PC are called Hi registers.

All 32-bit Thumb instructions can access R0 to R12, and LR. However, apart from a few designated stack manipulation instructions, most Thumb instructions cannot use SP. Except for a few specific instructions where PC is useful, most Thumb instructions cannot use PC.

In ARM state, all instructions can access R0 to R12, SP, and LR, and most instructions can also access PC (R15). However, the use of the SP in an ARM instruction, in any way that is not possible in the corresponding Thumb instruction, is deprecated. Explicit use of the PC in an ARM instruction is not usually useful, and except for specific instances that are useful, such use is deprecated. Implicit use of the PC, for example in branch instructions or load (literal) instructions, is never deprecated.

The MRS instructions can move the contents of a status register to a general-purpose register, where they can be manipulated by normal data processing operations. You can use the MSR instruction to move the contents of a general-purpose register to a status register.

Related concepts

- [2.9 General-purpose registers on page 2-44.](#)
- [2.15 Program Counter on page 2-50.](#)
- [2.16 Application Program Status Register on page 2-51.](#)
- [2.18 Current Program Status Register on page 2-53.](#)
- [2.19 Saved Program Status Registers on page 2-54.](#)
- [4.19 The Read-Modify-Write operation on page 4-88.](#)

Related references

- [2.11 Predeclared core register names on page 2-46.](#)
- [11.63 MRS \(PSR to general-purpose register\) on page 11-410.](#)
- [11.66 MSR \(general-purpose register to PSR\) on page 11-414.](#)

2.11 Predeclared core register names

Many of the core register names have synonyms.

The following table shows the predeclared core registers:

Table 2-2 Predeclared core registers

Register names	Meaning
r0-r15 and R0-R15	General purpose registers.
a1-a4	Argument, result or scratch registers. These are synonyms for R0 to R3
v1-v8	Variable registers. These are synonyms for R4 to R11.
sb and SB	Static base register. This is a synonym for R9.
ip and IP	Intra procedure call scratch register. This is a synonym for R12.
sp and SP	Stack pointer. This is a synonym for R13.
lr and LR	Link register. This is a synonym for R14.
pc and PC	Program counter. This is a synonym for R15.

With the exception of a1-a4 and v1-v8, you can write the registers either in all upper case or all lower case.

Related concepts

[2.9 General-purpose registers on page 2-44.](#)

2.12 Predeclared extension register names

You can write the names of NEON and VFP registers either in upper case or lower case.

The following extension register names are predeclared:

Table 2-3 Predeclared extension registers

Register names	Meaning
q0-q15 and Q0-Q15	NEON quadword registers
d0-d31 and D0-D31	NEON doubleword registers, VFP double-precision registers. ————— Note ————— Some versions of VFP have sixteen double-precision registers, D0-D15. —————
s0-s31 and S0-S31	VFP single-precision registers

Related concepts

[8.4 Extension register bank mapping in NEON on page 8-171.](#)

2.13 Predeclared XScale register names

When assembling for a Marvell XScale processor, you can use some additional predeclared register names.

These are as follows:

Table 2-4 Predeclared XScale registers

Register name	Meaning
acc0-acc7 and ACC0-ACC7	XScale accumulator registers

The following register names are predeclared when assembling for a Marvell XScale processor with Wireless MMX:

Table 2-5 Predeclared Wireless MMX registers

Register name	Meaning
wR0-wR15, wr0-wr15, and WR0-WR15	Wireless SIMD data registers (coprocessor 0).
wC0-wC15, wc0-wc15, and WC0-WC15	Usable aliases for coprocessor 1 registers. Use of these aliases is not recommended.
wCID, wcid, and WCID	Coprocessor ID register (coprocessor 1 register c0).
wCon, wcon, and WCON	Control register (coprocessor 1 register c1).
wCSSF, wcssf, and WCSSF	Saturation SIMD flags (coprocessor 1 register c2).
wCASf, wcasf, and WCASF	Arithmetic SIMD flags (coprocessor 1 register c3).
wCGR0-wCGR3, wcgr0-wcgr3, and WCGR0-WCGR3	General purpose registers (coprocessor 1 registers c8 - c11).

The predeclared XScale register names are case-sensitive and can be mixed case where this matches exactly the Wireless MMX Technology specification.

Control registers, ID register, general-purpose registers wCGR0-wCGR3 and the SIMD flags map onto coprocessor 1. Use the Wireless MMX Technology instructions TMCR and TMRC to read and write to these registers. The coprocessor 1 registers c4-c7 and c12-c15 are reserved.

SIMD data registers (wR0 - wR15) map onto coprocessor 0 and hold 16x64-bit packed data. Use the Wireless MMX Technology pseudo-instructions TMRRC and TMCRR to move data between these registers and the ARM registers.

The assembler supports the WRN and WCN directives to specify your own register names.

Related references

[Chapter 14 Wireless MMX Technology Instructions on page 14-749.](#)

2.14 Predeclared coprocessor names

There are ranges of predeclared coprocessor names and coprocessor register names. All names are case-sensitive.

Table 2-6 Predeclared coprocessor registers

Register name	Meaning
p0-p15	Coprocessors 0-15
c0-c15	Coprocessor registers 0-15

Related references

[11.26 CDP and CDP2](#) on page 11-350.

[11.52 MCR and MCR2](#) on page 11-397.

[11.61 MRC and MRC2](#) on page 11-408.

2.15 Program Counter

You can use the Program Counter explicitly, for example in some ARM data processing instructions, and implicitly, for example in branch instructions.

The *Program Counter* (PC) is accessed as PC (or R15). It is incremented by the size of the instruction executed (which is always four bytes in ARM state). Branch instructions load the destination address into PC. You can also load the PC directly using data processing instructions. For example, to branch to the address in a general purpose register, use:

```
MOV PC, R0
```

During execution, PC does not contain the address of the currently executing instruction. The address of the currently executing instruction is typically PC–8 for ARM, or PC–4 for Thumb.

————— **Note** —————

ARM recommends you use the BX instruction to jump to an address or to return from a function, rather than writing to the PC directly.

Related concepts

[7.5 Register-relative and PC-relative expressions on page 7-142.](#)

Related references

[11.16 B on page 11-335.](#)

[11.21 BL on page 11-342.](#)

[11.22 BLX on page 11-344.](#)

[11.23 BX on page 11-346.](#)

[11.24 BXJ on page 11-348.](#)

[11.25 CBZ and CBNZ on page 11-349.](#)

[11.151 TBB and TBH on page 11-527.](#)

2.16 Application Program Status Register

The *Application Program Status Register* (APSR) holds the program status flags that are accessible in any processor mode.

It holds copies of the N, Z, C, and V *condition flags*. The processor uses them to determine whether or not to execute conditional instructions.

On ARMv5TE, ARMv6 and later architectures, the APSR also holds the Q (saturation) flag.

On ARMv6 and later, the APSR also holds the GE (Greater than or Equal) flags. The GE flags can be set by the parallel add and subtract instructions. They are used by the SEL instruction to perform byte-based selection from two registers.

These flags are accessible in all modes, using the MSR and MRS instructions.

Related concepts

[5.1 Conditional instructions](#) on page 5-102.

[5.4 Updates to the condition flags](#) on page 5-105.

Related references

[11.63 MRS \(PSR to general-purpose register\)](#) on page 11-410.

[11.66 MSR \(general-purpose register to PSR\)](#) on page 11-414.

[11.102 SEL](#) on page 11-464.

2.17 The Q flag

The Q flag indicates overflow or saturation. It is one of the program status flags held in the APSR.

In ARMv5TE, ARMv6 and later, the Q flag is set to 1 when saturation has occurred in saturating arithmetic instructions, or when overflow has occurred in certain multiply instructions.

The Q flag is a sticky flag. Although the saturating and certain multiply instructions can set the flag, they cannot clear it. You can execute a series of such instructions, and then test the flag to find out whether saturation or overflow occurred at any point in the series, without having to check the flag after each instruction.

To clear the Q flag, use an MSR instruction to read-modify-write the APSR:

```
MRS r5, APSR
BIC r5, r5, #(1<<27)
MSR APSR_nzcvq, r5
```

The state of the Q flag cannot be tested directly by the condition codes. To read the state of the Q flag, use an MRS instruction.

```
MRS r6, APSR
TST r6, #(1<<27); Z is clear if Q flag was set
```

Related concepts

[4.19 The Read-Modify-Write operation](#) on page 4-88.

Related references

[11.63 MRS \(PSR to general-purpose register\)](#) on page 11-410.

[11.66 MSR \(general-purpose register to PSR\)](#) on page 11-414.

[11.77 QADD](#) on page 11-432.

[11.124 SMULxy](#) on page 11-488.

[11.126 SMULWy](#) on page 11-490.

2.18 Current Program Status Register

The *Current Program Status Register* (CPSR) holds the same program status flags as the APSR, and some additional information.

The CPSR holds:

- The APSR flags.
- The processor mode.
- The interrupt disable flags.
- The instruction set state (ARM, Thumb, ThumbEE, or Jazelle).
- The endianness state (on ARMv4T and later).
- The execution state bits for the IT block (on ARMv6T2 and later).

The execution state bits control conditional execution in the IT block.

Only the APSR flags are accessible in all modes. ARM deprecates using an MSR instruction to change the endianness bit (E) of the CPSR, in any mode. SETEND is the preferred instruction to write to the E bit.

The execution state bits for the IT block (IT[1:0]), Jazelle bit (J), and Thumb bit (T) can be accessed by MRS only in Debug state.

————— **Note** —————

The CPSR is not present in ARMv6-M and ARMv7-M processors.

Related concepts

[5.4 Updates to the condition flags on page 5-105.](#)

[2.19 Saved Program Status Registers on page 2-54.](#)

Related references

[11.39 IT on page 11-368.](#)

[11.63 MRS \(PSR to general-purpose register\) on page 11-410.](#)

[11.66 MSR \(general-purpose register to PSR\) on page 11-414.](#)

[11.103 SETEND on page 11-466.](#)

2.19 Saved Program Status Registers

A *Saved Program Status Register* (SPSR) stores the current value of the CPSR when an exception is taken so that the CPSR can be restored after handling the exception.

Each exception handling mode can access its own SPSR. User mode and System mode do not have an SPSR because they are not exception handling modes.

The execution state bits, including the endianness state and current instruction set state can be accessed from the SPSR in any exception mode, using the MSR and MRS instruction. You cannot access the SPSR using MSR or MRS in User or System mode.

Related concepts

[2.18 Current Program Status Register on page 2-53.](#)

Related information

[Handling Processor Exceptions.](#)

2.20 ARM and Thumb instruction set overview

ARM and Thumb instructions can be grouped by functional area.

All ARM instructions are 32 bits long. Instructions are stored word-aligned, so the least significant two bits of instruction addresses are always zero in ARM state.

Thumb instructions are either 16 or 32 bits long. Instructions are stored half-word aligned. Some instructions use the least significant bit of the address to determine whether the code being branched to is Thumb code or ARM code.

Before the introduction of 32-bit Thumb instructions, the Thumb instruction set was limited to a restricted subset of the functionality of the ARM instruction set. Almost all Thumb instructions were 16-bit. Together, the 32-bit and 16-bit Thumb instructions provide functionality that is almost identical to that of the ARM instruction set.

The following table describes some of the functional groupings of the available instructions:

Table 2-7 Instruction groups

Instruction Group	Description
Branch and control	These instructions do the following: <ul style="list-style-type: none"> • Branch to subroutines. • Branch backwards to form loops. • Branch forward in conditional structures. • Make following instructions conditional without branching. • Change the processor between ARM state and Thumb state.
Data processing	These instructions operate on the general-purpose registers. They can perform operations such as addition, subtraction, or bitwise logic on the contents of two registers and place the result in a third register. They can also operate on the value in a single register, or on a value in a register and an immediate value supplied within the instruction. Long multiply instructions give a 64-bit result in two registers.
Register load and store	These instructions load or store the value of a single register from or to memory. They can load or store a 32-bit word, a 16-bit halfword, or an 8-bit unsigned byte. Byte and halfword loads can either be sign extended or zero extended to fill the 32-bit register. A few instructions are also defined that can load or store 64-bit doubleword values into two 32-bit registers.
Multiple register load and store	These instructions load or store any subset of the general-purpose registers from or to memory.
Status register access	These instructions move the contents of a status register to or from a general-purpose register.
Coprocessor	These instructions support a general way to extend the ARM architecture. They also enable the control of the CP15 System Control coprocessor registers.

Related concepts

[4.13 Load and store multiple register instructions on page 4-80.](#)

Related references

[Chapter 11 ARM and Thumb Instructions on page 11-298.](#)

2.21 Access to the inline barrel shifter

The ARM arithmetic logic unit has a 32-bit barrel shifter that is capable of shift and rotate operations.

The second operand to many ARM and Thumb data-processing and single register data-transfer instructions can be shifted, before the data-processing or data-transfer is executed, as part of the instruction. This supports, but is not limited to:

- Scaled addressing.
- Multiplication by an immediate value.
- Constructing immediate values.

32-bit Thumb instructions give almost the same access to the barrel shifter as ARM instructions.

The 16-bit Thumb instructions only allow access to the barrel shifter using separate instructions.

Related concepts

[4.3 Load immediate values on page 4-67.](#)

[4.4 Load immediate values using MOV and MVN on page 4-68.](#)

Chapter 3

Structure of Assembly Language Modules

Describes the structure of assembly language source files.

It contains the following sections:

- *3.1 Syntax of source lines in assembly language* on page 3-58.
- *3.2 Literals* on page 3-60.
- *3.3 ELF sections and the AREA directive* on page 3-61.
- *3.4 An example ARM assembly language module* on page 3-62.

3.1 Syntax of source lines in assembly language

The assembler parses and assembles assembly language to produce object code.

Syntax

Each line of assembly language source code has this general form:

```
{symbol} {instruction|directive|pseudo-instruction} {;comment}
```

All three sections of the source line are optional.

symbol is usually a label. In instructions and pseudo-instructions it is always a label. In some directives it is a symbol for a variable or a constant. The description of the directive makes this clear in each case.

symbol must begin in the first column. It cannot contain any white space character such as a space or a tab unless it is enclosed by bars (|).

Labels are symbolic representations of addresses. You can use labels to mark specific addresses that you want to refer to from other parts of the code. Numeric local labels are a subclass of labels that begin with a number in the range 0-99. Unlike other labels, a numeric local label can be defined many times. This makes them useful when generating labels with a macro.

Directives provide important information to the assembler that either affects the assembly process or affects the final output image.

Instructions and pseudo-instructions make up the code a processor uses to perform tasks.

————— Note —————

Instructions, pseudo-instructions, and directives must be preceded by white space, such as a space or a tab, irrespective of whether there is a preceding label or not.

Some directives do not allow the use of a label.

A comment is the final part of a source line. The first semicolon on a line marks the beginning of a comment except where the semicolon appears inside a string literal. The end of the line is the end of the comment. A comment alone is a valid line. The assembler ignores all comments. You can use blank lines to make your code more readable.

Considerations when writing assembly language source code

You must write instruction mnemonics, pseudo-instructions, directives, and symbolic register names (except a1-a4, v1-v8, and Wireless MMX registers) in either all uppercase or all lowercase. You must not use mixed case. Labels and comments can be in uppercase, lowercase, or mixed case.

```

AREA      A32ex, CODE, READONLY
          ; Name this block of code A32ex
ENTRY    ; Mark first instruction to execute

start
MOV      r0, #10      ; Set up parameters
MOV      r1, #3
ADD      r0, r0, r1   ; r0 = r0 + r1

stop
MOV      r0, #0x18    ; angel_SWIreason_ReportException
LDR      r1, =0x20026 ; ADP_Stopped_ApplicationExit
SVC      #0x123456    ; ARM_semihosting (formerly SWI)
END      ; Mark end of file

```

To make source files easier to read, you can split a long line of source into several lines by placing a backslash character (\) at the end of the line. The backslash must not be followed by any other

characters, including spaces and tabs. The assembler treats the backslash followed by end-of-line sequence as white space. You can also use blank lines to make your code more readable.

Note

Do not use the backslash followed by end-of-line sequence within quoted strings.

The limit on the length of lines, including any extensions using backslashes, is 4095 characters.

Related concepts

[7.6 Labels on page 7-143.](#)

[7.10 Numeric local labels on page 7-147.](#)

[7.13 String literals on page 7-150.](#)

Related references

[3.2 Literals on page 3-60.](#)

[7.1 Symbol naming rules on page 7-138.](#)

[7.15 Syntax of numeric literals on page 7-152.](#)

3.2 Literals

Assembly language source code can contain numeric, string, Boolean, and single character literals.

Literals can be expressed as:

- Decimal numbers, for example 123.
- Hexadecimal numbers, for example 0x7B.
- Numbers in any base from 2 to 9, for example 5_204 is a number in base 5.
- Floating point numbers, for example 123.4.
- Boolean values {TRUE} or {FALSE}.
- Single character values enclosed by single quotes, for example 'w'.
- Strings enclosed in double quotes, for example "This is a string".

Note

In most cases, a string containing a single character is accepted as a single character value. For example `ADD r0,r1,#"a"` is accepted, but `ADD r0,r1,#"ab"` is faulted.

You can also use variables and names to represent literals.

Related references

[3.1 Syntax of source lines in assembly language on page 3-58.](#)

3.3 ELF sections and the AREA directive

Object files produced by the assembler are divided into sections. In assembly source code, you use the AREA directive to mark the start of a section.

ELF sections are independent, named, indivisible sequences of code or data. A single code section is the minimum required to produce an application.

The output of an assembly or compilation can include:

- One or more code sections. These are usually read-only sections.
- One or more data sections. These are usually read-write sections. They might be *zero-initialized (ZI)*.

The linker places each section in a program image according to section placement rules. Sections that are adjacent in source files are not necessarily adjacent in the application image

Use the AREA directive to name the section and set its attributes. The attributes are placed after the name, separated by commas.

You can choose any name for your sections. However, names starting with any non-alphabetic character must be enclosed in bars, or an AREA name missing error is generated. For example, |1_DataArea|.

The following example defines a single read-only section called ARMex that contains code:

```
AREA ARMex, CODE, READONLY ; Name this block of code ARMex
```

Related concepts

[3.4 An example ARM assembly language module on page 3-62.](#)

Related references

[15.6 AREA on page 15-767.](#)

Related information

[Information about scatter files.](#)

3.4 An example ARM assembly language module

An ARM assembly language module has several constituent parts.

These are:

- ELF sections (defined by the AREA directive).
- Application entry (defined by the ENTRY directive).
- Application execution.
- Application termination.
- Program end (defined by the END directive).

Constituents of an assembly language module

The following example defines a single section called ARMex that contains code and is marked as being READONLY.

```

AREA    ARMex, CODE, READONLY
        ; Name this block of code ARMex
ENTRY   ; Mark first instruction to execute
start
        MOV    r0, #10      ; Set up parameters
        MOV    r1, #3
        ADD    r0, r0, r1   ; r0 = r0 + r1
stop
        MOV    r0, #0x18    ; angel_SWIreason_ReportException
        LDR    r1, =0x20026 ; ADP_Stopped_ApplicationExit
        SVC    #0x123456    ; ARM semihosting (formerly SWI)
        END    ; Mark end of file
  
```

Application entry

The ENTRY directive declares an entry point to the program. It marks the first instruction to be executed. In applications using the C library, an entry point is also contained within the C library initialization code. Initialization code and exception handlers also contain entry points.

Application execution

The application code begins executing at the label `start`, where it loads the decimal values 10 and 3 into registers R0 and R1. These registers are added together and the result placed in R0.

Application termination

After executing the main code, the application terminates by returning control to the debugger. You do this using the ARM semihosting SVC (0x123456 by default), with the following parameters:

- R0 equal to `angel_SWIreason_ReportException` (0x18).
- R1 equal to `ADP_Stopped_ApplicationExit` (0x20026).

Program end

The END directive instructs the assembler to stop processing this source file. Every assembly language source module must finish with an END directive on a line by itself. Any lines following the END directive are ignored by the assembler.

Related concepts

[3.3 ELF sections and the AREA directive on page 3-61.](#)

Related references

[15.23 END on page 15-786.](#)

[15.25 ENTRY on page 15-788.](#)

Related information

[What is semihosting?.](#)

Chapter 4

Writing ARM Assembly Language

Describes the use of a few basic assembly language instructions and the use of macros.

It contains the following sections:

- [4.1 About the Unified Assembler Language](#) on page 4-65.
- [4.2 Register usage in subroutine calls](#) on page 4-66.
- [4.3 Load immediate values](#) on page 4-67.
- [4.4 Load immediate values using MOV and MVN](#) on page 4-68.
- [4.5 Load immediate values using MOV32](#) on page 4-69.
- [4.6 Load immediate values using LDR Rd, =const](#) on page 4-70.
- [4.7 Literal pools](#) on page 4-71.
- [4.8 Load addresses into registers](#) on page 4-73.
- [4.9 Load addresses to a register using ADR](#) on page 4-74.
- [4.10 Load addresses to a register using ADRL](#) on page 4-76.
- [4.11 Load addresses to a register using LDR Rd, =label](#) on page 4-77.
- [4.12 Other ways to load and store registers](#) on page 4-79.
- [4.13 Load and store multiple register instructions](#) on page 4-80.
- [4.14 Load and store multiple register instructions in ARM and Thumb](#) on page 4-81.
- [4.15 Stack implementation using LDM and STM](#) on page 4-82.
- [4.16 Stack operations for nested subroutines](#) on page 4-84.
- [4.17 Block copy with LDM and STM](#) on page 4-85.
- [4.18 Memory accesses](#) on page 4-87.
- [4.19 The Read-Modify-Write operation](#) on page 4-88.
- [4.20 Optional hash with immediate constants](#) on page 4-89.
- [4.21 Use of macros](#) on page 4-90.
- [4.22 Test-and-branch macro example](#) on page 4-91.
- [4.23 Unsigned integer division macro example](#) on page 4-92.

- [4.24 Instruction and directive relocations](#) on page 4-94.
- [4.25 Symbol versions](#) on page 4-96.
- [4.26 Frame directives](#) on page 4-97.
- [4.27 Exception tables and Unwind tables](#) on page 4-98.
- [4.28 Assembly language changes after RVCT v2.1](#) on page 4-99.

4.1 About the Unified Assembler Language

Unified Assembler Language (UAL) is a common syntax for ARM and Thumb instructions.

UAL supersedes earlier versions of both the ARM and Thumb assembler languages.

Code written using UAL can be assembled for ARM or Thumb for any ARM processor. The assembler faults the use of unavailable instructions.

RealView® Compilation Tools (RVCT) v2.1 and earlier can only assemble the pre-UAL syntax. Later versions of RVCT and ARM Compiler toolchain can assemble code written in pre-UAL and UAL syntax.

You can use directives or command-line options to instruct the assembler whether you are using UAL or pre-UAL syntax. By default, the assembler expects source code to be written in UAL. If you use any of the `CODE32`, `ARM`, `THUMB`, or `THUMBX` directives, or if you assemble with any of the `--32`, `--arm`, `--thumb`, or `--thumbx` command-line options, the assembler accepts UAL syntax. The assembler also accepts source code written in pre-UAL ARM assembly language when you use the `CODE32` or `ARM` directives.

The assembler accepts source code written in pre-UAL Thumb assembly language when you assemble using the `--16` command-line option, or you use the `CODE16` directive in the source code.

Note

The pre-UAL Thumb assembly language does not support 32-bit Thumb instructions.

Related references

[10.1 --16 on page 10-223.](#)

[15.7 ARM or CODE32 on page 15-770.](#)

[10.2 --32 on page 10-224.](#)

[10.4 --arm on page 10-227.](#)

[10.62 --thumb on page 10-288.](#)

[10.63 --thumbx on page 10-289.](#)

4.2 Register usage in subroutine calls

You use branch instructions to call and return from subroutines. The Procedure Call Standard for the ARM Architecture defines how to use registers in subroutine calls.

A subroutine is a block of code that performs a task based on some arguments and optionally returns a result. By convention, you use registers R0 to R3 to pass arguments to subroutines, and R0 to pass a result back to the callers. A subroutine that requires more than four inputs uses the stack for the additional inputs.

To call subroutines, use a branch and link instruction. The syntax is:

```
BL destination
```

where *destination* is usually the label on the first instruction of the subroutine.

destination can also be a PC-relative expression.

The BL instruction:

- Places the return address in the link register.
- Sets the PC to the address of the subroutine.

After the subroutine code has executed you can use a BX LR instruction to return.

Note

Calls between separately assembled or compiled modules must comply with the restrictions and conventions defined by the *Procedure Call Standard for the ARM Architecture*.

Example

The following example shows a subroutine, `doadd`, that adds the values of two arguments and returns a result in R0:

```

AREA    subrout, CODE, READONLY    ; Name this block of code
ENTRY                                     ; Mark first instruction to execute
start  MOV    r0, #10                ; Set up parameters
      MOV    r1, #3
      BL     doadd                  ; Call subroutine
stop   MOV    r0, #0x18              ; angel_SWIreason_ReportException
      LDR    r1, =0x20026           ; ADP_Stopped_ApplicationExit
      SVC    #0x123456             ; ARM semihosting (formerly SWI)
doadd  ADD    r0, r0, r1            ; Subroutine code
      BX    lr                     ; Return from subroutine
      END                                     ; Mark end of file

```

Related concepts

[4.16 Stack operations for nested subroutines on page 4-84.](#)

Related references

[11.16 B on page 11-335.](#)

Related information

[Procedure Call Standard for the ARM Architecture.](#)

4.3 Load immediate values

To represent some immediate values, you might have to use a sequence of instructions rather than a single instruction.

ARM and Thumb instructions can only be 32 bits wide. You can use a `MOV` or `MVN` instruction to load a register with an immediate value from a range that depends on the instruction set. Certain 32-bit values cannot be represented as an immediate operand to a single 32-bit instruction, although you can load these values from memory in a single instruction.

In ARMv6T2 and later, you can load any 32-bit immediate value into a register with two instructions, a `MOV` followed by a `MOVT`. Or, you can use a pseudo-instruction, `MOV32`, to construct the instruction sequence for you.

You can also use the `LDR` pseudo-instruction to load immediate values into a register.

You can include many commonly-used immediate values directly as operands within data processing instructions, without a separate load operation. The range of immediate values that you can include as operands in 16-bit Thumb instructions is much smaller.

Related concepts

[4.4 Load immediate values using `MOV` and `MVN` on page 4-68.](#)

[4.5 Load immediate values using `MOV32` on page 4-69.](#)

[4.6 Load immediate values using `LDR Rd, =const` on page 4-70.](#)

[8.6 Load values to NEON registers on page 8-174.](#)

Related references

[11.46 `LDR` pseudo-instruction on page 11-386.](#)

4.4 Load immediate values using MOV and MVN

The MOV and MVN instructions can write a range of immediate values to a register.

In both ARM and Thumb, you do not have to decide whether to use MOV or MVN. The assembler uses whichever is appropriate. This is useful if the value is an assembly-time variable.

If you write an instruction with an immediate value that is not available, the assembler reports the error: Immediate *n* out of range for this operation.

Related concepts

[4.3 Load immediate values on page 4-67.](#)

4.5 Load immediate values using MOV32

To load any 32-bit immediate value, a pair of MOV and MOVT instructions is equivalent to a MOV32 pseudo-instruction.

In ARMv6T2 and later, both ARM and Thumb instruction sets include:

- A MOV instruction that can load any value in the range 0x00000000 to 0x0000FFFF into a register.
- A MOVT instruction that can load any value in the range 0x0000 to 0xFFFF into the most significant half of a register, without altering the contents of the least significant half.

You can use these two instructions to construct any 32-bit immediate value in a register. Alternatively, you can use the MOV32 pseudo-instruction. The assembler generates the MOV, MOVT instruction pair for you.

You can also use the MOV32 instruction to load addresses into registers by using a label or any PC-relative expression in place of an immediate value. The assembler puts a relocation directive into the object file for the linker to resolve the address at link-time.

Related concepts

[7.5 Register-relative and PC-relative expressions on page 7-142.](#)

Related references

[11.58 MOV32 pseudo-instruction on page 11-405.](#)

4.6 Load immediate values using LDR Rd, =const

The LDR Rd, =const pseudo-instruction generates the most efficient single instruction to load any 32-bit number.

You can use this pseudo-instruction to generate constants that are out of range of the MOV and MVN instructions.

The LDR pseudo-instruction generates the most efficient single instruction for the specified immediate value:

- If the immediate value can be constructed with a single MOV or MVN instruction, the assembler generates the appropriate instruction.
- If the immediate value cannot be constructed with a single MOV or MVN instruction, the assembler:
 - Places the value in a *literal pool* (a portion of memory embedded in the code to hold constant values).
 - Generates an LDR instruction with a PC-relative address that reads the constant from the literal pool.

For example:

```
LDR    rn, [pc, #offset to literal pool]
        ; load register n with one word
        ; from the address [pc + offset]
```

You must ensure that there is a literal pool within range of the LDR instruction generated by the assembler.

Related concepts

[4.7 Literal pools on page 4-71.](#)

Related references

[11.46 LDR pseudo-instruction on page 11-386.](#)

4.7 Literal pools

The assembler uses literal pools to store some constant data in code sections. You can use the `LTORG` directive to ensure a literal pool is within range.

The assembler places a literal pool at the end of each section. The end of a section is defined either by the `END` directive at the end of the assembly or by the `AREA` directive at the start of the following section. The `END` directive at the end of an included file does not signal the end of a section.

In large sections the default literal pool can be out of range of one or more `LDR` instructions. The offset from the PC to the constant must be:

- Less than 4KB in ARM or Thumb code when the 32-bit `LDR` instruction is available, but can be in either direction.
- Forward and less than 1KB when only the 16-bit Thumb `LDR` instruction is available.

When an `LDR Rd, =const` pseudo-instruction requires the immediate value to be placed in a literal pool, the assembler:

- Checks if the value is available and addressable in any previous literal pools. If so, it addresses the existing constant.
- Attempts to place the value in the next literal pool if it is not already available.

If the next literal pool is out of range, the assembler generates an error message. In this case you must use the `LTORG` directive to place an additional literal pool in the code. Place the `LTORG` directive after the failed `LDR` pseudo-instruction, and within the valid range for an `LDR` instruction.

You must place literal pools where the processor does not attempt to execute them as instructions. Place them after unconditional branch instructions, or after the return instruction at the end of a subroutine.

Example of placing literal pools

The following example shows the placement of literal pools. The instructions listed as comments are the ARM instructions generated by the assembler.

```

AREA          Loadcon, CODE, READONLY
ENTRY
; Mark first instruction to execute
start
BL          func1          ; Branch to first subroutine
BL          func2          ; Branch to second subroutine
stop
MOV         r0, #0x18      ; angel_SWIreason_ReportException
LDR         r1, =0x20026   ; ADP_Stopped_ApplicationExit
SVC         #0x123456     ; ARM semihosting (formerly SWI)
func1
LDR         r0, =42        ; => MOV R0, #42
LDR         r1, =0x55555555 ; => LDR R1, [PC, #offset to
                          ; Literal Pool 1]
LDR         r2, =0xFFFFFFFF ; => MVN R2, #0
BX          lr
LTORG
; Literal Pool 1 contains
; literal 0x55555555
func2
LDR         r3, =0x55555555 ; => LDR R3, [PC, #offset to
                          ; Literal Pool 1]
; LDR r4, =0x66666666      ; If this is uncommented it
                          ; fails, because Literal Pool 2
                          ; is out of reach
BX          lr
LargeTable
SPACE      4200           ; Starting at the current location,
                          ; clears a 4200 byte area of memory
                          ; to zero
END
; Literal Pool 2 is inserted here,
; but is out of range of the LDR
; pseudo-instruction that needs it

```

Related concepts

[4.6 Load immediate values using `LDR Rd, =const` on page 4-70.](#)

Related references

[15.50 LTOrg](#) on page 15-816.

4.8 Load addresses into registers

It is often necessary to load an address into a register. There are several ways to do this.

For example, you might have to load the address of a variable, a string literal, or the start location of a jump table.

Addresses are normally expressed as offsets from a label, or from the current PC or other register.

You can load an address into a register either:

- Using the instruction `ADR`.
- Using the pseudo-instruction `ADRL`.
- Using the pseudo-instruction `MOV32`.
- From a literal pool using the pseudo-instruction `LDR Rd, =Label`.

Related concepts

[4.9 Load addresses to a register using `ADR`](#) on page 4-74.

[4.10 Load addresses to a register using `ADRL`](#) on page 4-76.

[4.5 Load immediate values using `MOV32`](#) on page 4-69.

[4.11 Load addresses to a register using `LDR Rd, =label`](#) on page 4-77.

4.9 Load addresses to a register using ADR

The ADR instruction loads an address within a certain range, without performing a data load.

ADR accepts a PC-relative expression, that is, a label with an optional offset where the address of the label is relative to the PC.

————— **Note** —————

The label used with ADR must be within the same code section. The assembler faults references to labels that are out of range in the same section.

The available range of addresses for the ADR instruction depends on the instruction set and encoding:

ARM

Any value that can be produced by rotating an 8-bit value right by any even number of bits within a 32-bit word. The range is relative to the PC.

32-bit Thumb encoding

±4095 bytes to a byte, halfword, or word-aligned address.

16-bit Thumb encoding

0 to 1020 bytes. *Label* must be word-aligned. You can use the ALIGN directive to ensure this.

Example of a jump table implementation with ADR

This example shows ARM code that implements a jump table. Here, the ADR instruction loads the address of the jump table.

```

AREA    Jump, CODE, READONLY ; Name this block of code
ARM                                          ; Following code is ARM code

num    EQU    2                      ; Number of entries in jump table
start  ENTRY                                ; Mark first instruction to execute
        MOV    r0, #0                  ; First instruction to call
        MOV    r1, #3                  ; Set up the three arguments
        MOV    r2, #2
        BL    arithfunc                ; Call the function
stop

arithfunc  MOV    r0, #0x18             ; angel_SWIreason_ReportException
            LDR    r1, =0x20026         ; ADP_Stopped_ApplicationExit
            SVC    #0x123456           ; ARM_semihosting (formerly SWI)
            ; Label the function
            CMP    r0, #num            ; Treat function code as unsigned
            ; integer
            BXHS  lr                    ; If code is >= num then return
            ADR    r3, JumpTable        ; Load address of jump table
            LDR    pc, [r3,r0,LSL#2]    ; Jump to the appropriate routine
JumpTable
        DCD    DoAdd
        DCD    DoSub
DoAdd
        ADD    r0, r1, r2              ; Operation 0
        BX    lr                       ; Return
DoSub
        SUB    r0, r1, r2              ; Operation 1
        BX    lr                       ; Return
END                                          ; Mark the end of this file

```

In this example, the function `arithfunc` takes three arguments and returns a result in `R0`. The first argument determines the operation to be carried out on the second and third arguments:

argument1=0

Result = argument2 + argument3.

argument1=1

Result = argument2 – argument3.

The jump table is implemented with the following instructions and assembler directives:

EQU

Is an assembler directive. You use it to give a value to a symbol. In this example, it assigns the value 2 to *num*. When *num* is used elsewhere in the code, the value 2 is substituted. Using EQU in this way is similar to using `#define` to define a constant in C.

DCD

Declares one or more words of store. In this example, each DCD stores the address of a routine that handles a particular clause of the jump table.

LDR

The `LDR PC, [R3, R0, LSL#2]` instruction loads the address of the required clause of the jump table into the PC. It:

- Multiplies the clause number in R0 by 4 to give a word offset.
- Adds the result to the address of the jump table.
- Loads the contents of the combined address into the PC.

Related concepts

[4.11 Load addresses to a register using LDR Rd, =label](#) on page 4-77.

[4.10 Load addresses to a register using ADRL](#) on page 4-76.

Related references

[11.11 ADR \(PC-relative\)](#) on page 11-325.

4.10 Load addresses to a register using ADRL

The ADRL pseudo-instruction loads an address within a certain range, without performing a data load. The range is wider than that of the ADR instruction.

ADRL accepts a PC-relative expression, that is, a label with an optional offset where the address of the label is relative to the current PC.

————— **Note** —————

The label used with ADRL must be within the same code section. The assembler faults references to labels that are out of range in the same section.

ADRL is not available in Thumb state on processors before ARMv6T2.

The assembler converts an ADRL *rn, Label* pseudo-instruction by generating:

- Two data processing instructions that load the address, if it is in range.
- An error message if the address cannot be constructed in two instructions.

The available range depends on the instruction set and encoding.

ARM

Any value that can be generated by two ADD or two SUB instructions. That is, any value that can be produced by the addition of two values, each of which is 8 bits rotated right by any even number of bits within a 32-bit word. The range is relative to the PC.

32-bit Thumb encoding

±1MB to a byte, halfword, or word-aligned address.

16-bit Thumb encoding

ADRL is not available.

Related concepts

[4.9 Load addresses to a register using ADR on page 4-74.](#)

[4.11 Load addresses to a register using LDR Rd, =label on page 4-77.](#)

4.11 Load addresses to a register using LDR Rd, =label

The LDR *Rd*,=*Label* pseudo-instruction places an address in a literal pool and then loads the address into a register.

LDR *Rd*,=*Label* can load any 32-bit numeric value into a register. It also accepts PC-relative expressions such as labels, and labels with offsets.

The assembler converts an LDR *Rd*,=*Label* pseudo-instruction by:

- Placing the address of *Label* in a literal pool (a portion of memory embedded in the code to hold constant values).
- Generating a PC-relative LDR instruction that reads the address from the literal pool, for example:

```
LDR rn [pc, #offset_to_literal_pool]
        ; load register n with one word
        ; from the address [pc + offset]
```

You must ensure that the literal pool is within range of the LDR pseudo-instruction that needs to access it.

Example of loading using LDR Rd, =label

The following example shows a section with two literal pools. The final LDR pseudo-instruction needs to access the second literal pool, but it is out of range. Uncommenting this line causes the assembler to generate an error.

The instructions listed in the comments are the ARM instructions generated by the assembler.

```
AREA LDRlabel, CODE, READONLY
ENTRY
        ; Mark first instruction to execute
start
        BL    func1          ; Branch to first subroutine
        BL    func2          ; Branch to second subroutine
stop
        MOV   r0, #0x18      ; angel_SWIreason_ReportException
        LDR   r1, =0x20026   ; ADP_Stopped_ApplicationExit
        SVC   #0x123456     ; ARM semihosting (formerly SWI)
func1
        LDR   r0, =start     ; => LDR r0,[PC, #offset into Literal Pool 1]
        LDR   r1, =Darea + 12 ; => LDR r1,[PC, #offset into Literal Pool 1]
        LDR   r2, =Darea + 6000 ; => LDR r2,[PC, #offset into Literal Pool 1]
        BX   lr              ; Return
        LTORG                ; Literal Pool 1
func2
        LDR   r3, =Darea + 6000 ; => LDR r3,[PC, #offset into Literal Pool 1]
        ; LDR   r4, =Darea + 6004 ; (sharing with previous literal)
        ; If uncommented, produces an error because
        ; Literal Pool 2 is out of range.
        BX   lr              ; Return
Darea  SPACE 8000            ; Starting at the current location, clears
        END                  ; a 8000 byte area of memory to zero.
        ; Literal Pool 2 is automatically inserted
        ; after the END directive.
        ; It is out of range of all the LDR
        ; pseudo-instructions in this example.
```

Example of string copy

The following example shows an ARM code routine that overwrites one string with another. It uses the LDR pseudo-instruction to load the addresses of the two strings from a data section. The following are particularly significant:

DCB

The DCB directive defines one or more bytes of store. In addition to integer values, DCB accepts quoted strings. Each character of the string is placed in a consecutive byte.

LDR, STR

The LDR and STR instructions use post-indexed addressing to update their address registers. For example, the instruction:

```
LDRB    r2, [r1], #1
```

loads R2 with the contents of the address pointed to by R1 and then increments R1 by 1.

The example also shows how, unlike the ADR and ADRL pseudo-instructions, you can use the LDR pseudo-instruction with labels that are outside the current section. The assembler places a relocation directive in the object code when the source file is assembled. The relocation directive instructs the linker to resolve the address at link time. The address remains valid wherever the linker places the section containing the LDR and the literal pool.

```

start    AREA StrCopy, CODE, READONLY
         ENTRY                ; Mark first instruction to execute
         LDR    r1, =srcstr    ; Pointer to first string
         LDR    r0, =dststr    ; Pointer to second string
         BL     strcpy        ; Call subroutine to do copy
stop     MOV    r0, #0x18     ; angel_SWIreason_ReportException
         LDR    r1, =0x20026   ; ADP_Stopped_ApplicationExit
         SVC    #0x123456     ; ARM semihosting (formerly SWI)
strcpy   LDRB   r2, [r1], #1   ; Load byte and update address
         STRB   r2, [r0], #1   ; Store byte and update address
         CMP    r2, #0        ; Check for zero terminator
         BNE   strcpy        ; Keep going if not
         MOV   pc, lr         ; Return
srcstr   AREA Strings, DATA, READWRITE
dststr   DCB   "First string - source", 0
         DCB   "Second string - destination", 0
         END

```

Related concepts

[4.10 Load addresses to a register using ADRL on page 4-76.](#)

[4.6 Load immediate values using LDR Rd, =const on page 4-70.](#)

Related references

[11.46 LDR pseudo-instruction on page 11-386.](#)

[15.15 DCB on page 15-778.](#)

4.12 Other ways to load and store registers

You can load and store registers using LDR, STR and MOV (register) instructions.

You can load any 32-bit value from memory into a register with an LDR data load instruction. To store registers into memory you can use the STR data store instruction.

You can use the MOV instruction to move any 32-bit data from one register to another.

Related concepts

[4.13 Load and store multiple register instructions](#) on page 4-80.

Related references

[4.14 Load and store multiple register instructions in ARM and Thumb](#) on page 4-81.

[11.57 MOV](#) on page 11-403.

4.13 Load and store multiple register instructions

The ARM and Thumb instruction sets include instructions that load and store multiple registers. These instructions can provide a more efficient way of transferring the contents of several registers to and from memory than using single register loads and stores.

Multiple register transfer instructions are most often used for block copy and for stack operations at subroutine entry and exit. The advantages of using a multiple register transfer instruction instead of a series of single data transfer instructions include:

- Smaller code size.
- A single instruction fetch overhead, rather than many instruction fetches.
- On uncached ARM processors, the first word of data transferred by a load or store multiple is always a nonsequential memory cycle, but all subsequent words transferred can be sequential memory cycles. Sequential memory cycles are faster in most systems.

Note

The lowest numbered register is transferred to or from the lowest memory address accessed, and the highest numbered register to or from the highest address accessed. The order of the registers in the register list in the instructions makes no difference.

You can use the `--diag_warning 1206` assembler command line option to check that registers in register lists are specified in increasing order.

Related concepts

[4.15 Stack implementation using LDM and STM on page 4-82.](#)

[4.16 Stack operations for nested subroutines on page 4-84.](#)

[4.17 Block copy with LDM and STM on page 4-85.](#)

Related references

[4.14 Load and store multiple register instructions in ARM and Thumb on page 4-81.](#)

4.14 Load and store multiple register instructions in ARM and Thumb

Instructions are available in both the ARM and Thumb instruction sets to load and store multiple registers.

They are:

LDM

Load Multiple registers.

STM

Store Multiple registers.

PUSH

Store multiple registers onto the stack and update the stack pointer.

POP

Load multiple registers off the stack, and update the stack pointer.

In LDM and STM instructions:

- The list of registers loaded or stored can include:
 - In ARM instructions, any or all of R0-R12, SP, LR, and PC.
 - In 32-bit Thumb instructions, any or all of R0-R12, and optionally LR or PC (LDM only) with some restrictions.
 - In 16-bit Thumb instructions, any or all of R0-R7.
- The address can be:
 - Incremented after each transfer.
 - Incremented before each transfer (ARM instructions only).
 - Decrement after each transfer (ARM instructions only).
 - Decrement before each transfer (not in 16-bit encoded Thumb instructions).
- The base register can be either:
 - Updated to point to the next block of data in memory.
 - Left as it was before the instruction.

When the base register is updated to point to the next block in memory, this is called writeback, that is, the adjusted address is written back to the base register.

In PUSH and POP instructions:

- The stack pointer (SP) is the base register, and is always updated.
- The address is incremented after each transfer in POP instructions, and decremented before each transfer in PUSH instructions.
- The list of registers loaded or stored can include:
 - In ARM instructions, any or all of R0-R12, SP, LR, and PC.
 - In 32-bit Thumb instructions, any or all of R0-R12, and optionally LR or PC (POP only) with some restrictions.
 - In 16-bit Thumb instructions, any or all of R0-R7, and optionally LR (PUSH only) or PC (POP only).

Note

Use of SP in the list of registers in these ARM instructions is deprecated.

ARM STM and PUSH instructions that use PC in the list of registers, and ARM LDM and POP instructions that use both PC and LR in the list of registers are deprecated.

Related concepts

[4.13 Load and store multiple register instructions on page 4-80.](#)

4.15 Stack implementation using LDM and STM

You can use the LDM and STM instructions to implement pop and push operations respectively. You use a suffix to indicate the stack type.

The load and store multiple instructions can update the base register. For stack operations, the base register is usually the stack pointer, SP. This means that you can use these instructions to implement push and pop operations for any number of registers in a single instruction.

The load and store multiple instructions can be used with several types of stack:

Descending or ascending

The stack grows downwards, starting with a high address and progressing to a lower one (a *descending* stack), or upwards, starting from a low address and progressing to a higher address (an *ascending* stack).

Full or empty

The stack pointer can either point to the last item in the stack (a *full* stack), or the next free space on the stack (an *empty* stack).

To make it easier for the programmer, stack-oriented suffixes can be used instead of the increment or decrement, and before or after suffixes. The following table shows the stack-oriented suffixes and their equivalent addressing mode suffixes for load and store instructions:

Table 4-1 Stack-oriented suffixes and equivalent addressing mode suffixes

Stack-oriented suffix	For store or push instructions	For load or pop instructions
FD (Full Descending stack)	DB (Decrement Before)	IA (Increment After)
FA (Full Ascending stack)	IB (Increment Before)	DA (Decrement After)
ED (Empty Descending stack)	DA (Decrement After)	IB (Increment Before)
EA (Empty Ascending stack)	IA (Increment After)	DB (Decrement Before)

The following table shows the load and store multiple instructions with the stack-oriented suffixes for the various stack types:

Table 4-2 Suffixes for load and store multiple instructions

Stack type	Store	Load
Full descending	STMGD (STMDB, Decrement Before)	LDMGD (LDM, increment after)
Full ascending	STMFA (STMIB, Increment Before)	LDMFA (LDMDA, Decrement After)
Empty descending	STMED (STMDA, Decrement After)	LDMED (LDMIB, Increment Before)
Empty ascending	STMFA (STM, increment after)	LDMFA (LDMDB, Decrement Before)

For example:

```

STMFD    sp!, {r0-r5} ; Push onto a Full Descending Stack
LDMFD    sp!, {r0-r5} ; Pop from a Full Descending Stack
    
```

Note

The *Procedure Call Standard for the ARM Architecture* (AAPCS), and `armcc` always use a full descending stack.

The PUSH and POP instructions assume a full descending stack. They are the preferred synonyms for STMDB and LDM with writeback.

Related concepts

4.13 Load and store multiple register instructions on page 4-80.

Related references

11.41 LDM on page 11-372.

Related information

Procedure Call Standard for the ARM Architecture.

4.16 Stack operations for nested subroutines

Stack operations can be very useful at subroutine entry and exit to avoid losing register contents if other subroutines are called.

At the start of a subroutine, any working registers required can be stored on the stack, and at exit they can be popped off again.

In addition, if the link register is pushed onto the stack at entry, additional subroutine calls can be made safely without causing the return address to be lost. If you do this, you can also return from a subroutine by popping the PC off the stack at exit, instead of popping the LR and then moving that value into the PC. For example:

```
subroutine  PUSH    {r5-r7,lr} ; Push work registers and lr
           ; code
           BL      somewhere_else
           ; code
           POP     {r5-r7,pc} ; Pop work registers and pc
```

Note

Use this with care in mixed ARM and Thumb systems. In ARMv4T systems, you cannot change state by popping directly into PC. In these cases you must pop the address into a temporary register and use the BX instruction.

In ARMv5T and later, you can change state in this way.

Related concepts

[4.2 Register usage in subroutine calls](#) on page 4-66.

[4.13 Load and store multiple register instructions](#) on page 4-80.

Related information

Procedure Call Standard for the ARM Architecture.

Interworking ARM and Thumb.

4.17 Block copy with LDM and STM

You can sometimes make code more efficient by using LDM and STM instead of LDR and STR instructions.

Example of block copy without LDM and STM

The following example is an ARM code routine that copies a set of words from a source location to a destination a single word at a time:

```

num    AREA    Word, CODE, READONLY ; name the block of code
      EQU     20                      ; set number of words to be copied
      ENTRY                      ; mark the first instruction called
start
      LDR     r0, =src                ; r0 = pointer to source block
      LDR     r1, =dst                ; r1 = pointer to destination block
      MOV     r2, #num                ; r2 = number of words to copy
wordcopy
      LDR     r3, [r0], #4            ; load a word from the source and
      STR     r3, [r1], #4            ; store it to the destination
      SUBS   r2, r2, #1              ; decrement the counter
      BNE    wordcopy                ; ... copy more
stop
      MOV     r0, #0x18                ; angel_SWIreason_ReportException
      LDR     r1, =0x20026            ; ADP_Stopped_ApplicationExit
      SVC    #0x123456                ; ARM semihosting (formerly SWI)

src    AREA    BlockData, DATA, READWRITE
dst    DCD    1,2,3,4,5,6,7,8,1,2,3,4,5,6,7,8,1,2,3,4
      DCD    0,0,0,0,0,0,0,0,0,0,0,0,0,0,0,0,0,0,0,0
      END

```

You can make this module more efficient by using LDM and STM for as much of the copying as possible. Eight is a sensible number of words to transfer at a time, given the number of available registers. You can find the number of eight-word multiples in the block to be copied (if R2 = number of words to be copied) using:

```
MOVS   r3, r2, LSR #3 ; number of eight word multiples
```

You can use this value to control the number of iterations through a loop that copies eight words per iteration. When there are fewer than eight words left, you can find the number of words left (assuming that R2 has not been corrupted) using:

```
ANDS   r2, r2, #7
```

Example of block copy using LDM and STM

The following example lists the block copy module rewritten to use LDM and STM for copying:

```

num    AREA    Block, CODE, READONLY ; name this block of code
      EQU     20                      ; set number of words to be copied
      ENTRY                      ; mark the first instruction called
start
      LDR     r0, =src                ; r0 = pointer to source block
      LDR     r1, =dst                ; r1 = pointer to destination block
      MOV     r2, #num                ; r2 = number of words to copy
      MOV     sp, #0x400              ; Set up stack pointer (sp)
blockcopy
      MOVS   r3,r2, LSR #3            ; Number of eight word multiples
      BEQ    copywords                ; Fewer than eight words to move?
      PUSH   {r4-r11}                 ; Save some working registers
octcopy
      LDM    r0!, {r4-r11}             ; Load 8 words from the source
      STM    r1!, {r4-r11}             ; and put them at the destination
      SUBS   r3, r3, #1                ; Decrement the counter
      BNE    octcopy                  ; ... copy more
      POP    {r4-r11}                 ; Don't require these now - restore
      ; originals
copywords
      ANDS   r2, r2, #7                ; Number of odd words to copy
      BEQ    stop                      ; No words left to copy?
wordcopy
      LDR     r3, [r0], #4            ; Load a word from the source and
      STR     r3, [r1], #4            ; store it to the destination
      SUBS   r2, r2, #1                ; Decrement the counter
      BNE    wordcopy                  ; ... copy more
stop

```

```
MOV    r0, #0x18           ; angel_SWIreason_ReportException
LDR    r1, =0x20026        ; ADP_Stopped_ApplicationExit
SVC    #0x123456           ; ARM semihosting (formerly SWI)

AREA   BlockData, DATA, READWRITE
src    DCD 1,2,3,4,5,6,7,8,1,2,3,4,5,6,7,8,1,2,3,4
dst    DCD 0,0,0,0,0,0,0,0,0,0,0,0,0,0,0,0,0,0,0,0
END
```

Note

The purpose of this example is to show the use of the LDM and STM instructions. There are other ways to perform bulk copy operations, the most efficient of which depends on many factors and is outside the scope of this document.

Related information

What is the fastest way to copy memory on a Cortex-A8?

4.18 Memory accesses

Many load and store instructions support different addressing modes.

Offset addressing

The offset value is applied to an address obtained from the base register. The result is used as the address for the memory access. The base register is unchanged. The assembly language syntax for this mode is:

```
[Rn, offset]
```

Pre-indexed addressing

The offset value is applied to an address obtained from the base register. The result is used as the address for the memory access, and written back into the base register. The assembly language syntax for this mode is:

```
[Rn, offset]!
```

Post-indexed addressing

The address obtained from the base register is used, unchanged, as the address for the memory access. The offset value is applied to the address, and written back into the base register. The assembly language syntax for this mode is:

```
[Rn], offset
```

In each case, *Rn* is the base register and *offset* can be:

- An immediate constant.
- An index register, *Rm*.
- A shifted index register, such as *Rm*, LSL #*shift*.

Related concepts

[6.16 Address alignment](#) on page 6-134.

Related references

[2.8 ARM registers](#) on page 2-42.

4.19 The Read-Modify-Write operation

The read-modify-write operation ensures that you modify only the specific bits in a system register that you want to change.

Individual bits in a system register control different system functionality. Modifying the wrong bits in a system register might cause your program to behave incorrectly.

The following example shows how to use the read-modify-write procedure to change some bits in the NEON and VFP system register FPSCR, without affecting the other bits:

```

VMRS    r10,FPSCR           ; copy FPSCR into the general-purpose r10
BIC     r10,r10,#0x00370000 ; clear STRIDE bits[21:20] and LEN bits[18:16]
ORR     r10,r10,#0x00300000 ; set bits[17:16] (STRIDE =1 and LEN = 4)
VMSR   FPSCR,r10           ; copy r10 back into FPSCR

```

To read-modify-write a system register, the instruction sequence is:

1. The first instruction copies the value from the target system register to a temporary general-purpose register.
2. The next one or more instructions modify the required bits in the general-purpose register. This can be one or both of:
 - BIC to clear to 0 only the bits that must be cleared.
 - ORR to set to 1 only the bits that must be set.
3. The final instruction writes the value from the general-purpose register to the target system register.

Related concepts

[2.10 Register accesses](#) on page 2-45.

[2.17 The Q flag](#) on page 2-52.

Related references

[11.63 MRS \(PSR to general-purpose register\)](#) on page 11-410.

[11.66 MSR \(general-purpose register to PSR\)](#) on page 11-414.

[13.21 VMRS](#) on page 13-735.

4.20 Optional hash with immediate constants

You do not have to specify a hash before an immediate constant in any instruction syntax.

This applies to ARM, Thumb, Wireless MMX, NEON, and VFP instructions. For example, the following are valid instructions:

```
BKPT 100  
MOVT R1, 256  
VCEQ.I8 Q1, Q2, 0
```

By default, the assembler warns if you do not specify a hash:

```
WARNING: A1865W: '#' not seen before constant expression.
```

You can suppress this with `--diag_suppress=1865`.

If you use the assembly code with another assembler, you are advised to use the `#` before all immediates. The disassembler always shows the `#` for clarity.

Related references

[Chapter 11 ARM and Thumb Instructions](#) on page 11-298.

[Chapter 13 VFP Instructions](#) on page 13-712.

4.21 Use of macros

A macro definition is a block of code enclosed between `MACRO` and `MEND` directives. It defines a name that you can use as a convenient alternative to repeating the block of code.

The main uses for a macro are:

- To make it easier to follow the logic of the source code by replacing a block of code with a single meaningful name.
- To avoid repeating a block of code several times.

Related concepts

[4.22 Test-and-branch macro example on page 4-91.](#)

[4.23 Unsigned integer division macro example on page 4-92.](#)

Related references

[15.51 `MACRO` and `MEND` on page 15-817.](#)

4.22 Test-and-branch macro example

You can use a macro to perform a test-and-branch operation.

In ARM code in any processor and in Thumb code in processors before ARMv6T2, a test-and-branch operation requires two instructions to implement.

You can define a macro such as this:

```

MACRO
$label TestAndBranch $dest, $reg, $cc
$label CMP    $reg, #0
      B$cc   $dest
MEND

```

The line after the MACRO directive is the *macro prototype statement*. This defines the name (TestAndBranch) you use to invoke the macro. It also defines parameters (\$label, \$dest, \$reg, and \$cc). Unspecified parameters are substituted with an empty string. For this macro you must give values for \$dest, \$reg and \$cc to avoid syntax errors. The assembler substitutes the values you give into the code.

This macro can be invoked as follows:

```

test   TestAndBranch   NonZero, r0, NE
      ...
      ...
NonZero

```

After substitution this becomes:

```

test   CMP    r0, #0
      BNE    NonZero
      ...
      ...
NonZero

```

Related concepts

[4.21 Use of macros on page 4-90.](#)

[4.23 Unsigned integer division macro example on page 4-92.](#)

[7.10 Numeric local labels on page 7-147.](#)

4.23 Unsigned integer division macro example

You can use a macro to perform unsigned integer division.

The macro takes the following parameters:

\$Bot	The register that holds the divisor.
\$Top	The register that holds the dividend before the instructions are executed. After the instructions are executed, it holds the remainder.
\$Div	The register where the quotient of the division is placed. It can be NULL ("") if only the remainder is required.
\$Temp	A temporary register used during the calculation.

Example unsigned integer division with a macro

```

MACRO
$Lab  DivMod $Div,$Top,$Bot,$Temp
      ASSERT $Top <> $Bot      ; Produce an error message if the
      ASSERT $Top <> $Temp      ; registers supplied are
      ASSERT $Bot <> $Temp      ; not all different
      IF "$Div" <> ""
          ASSERT $Div <> $Top    ; These three only matter if $Div
          ASSERT $Div <> $Bot    ; is not null ("")
          ASSERT $Div <> $Temp    ;
      ENDFIF
$Lab  MOV     $Temp, $Bot        ; Put divisor in $Temp
      CMP     $Temp, $Top, LSR #1 ; double it until
90     MOVLS  $Temp, $Temp, LSL #1 ; 2 * $Temp > $Top
      CMP     $Temp, $Top, LSR #1
      BLS    %b90              ; The b means search backwards
      IF     "$Div" <> ""
          MOV     $Div, #0      ; Initialize quotient
      ENDFIF
91     CMP     $Top, $Temp      ; Can we subtract $Temp?
      SUBCS  $Top, $Top,$Temp  ; If we can, do so
      IF     "$Div" <> ""
          ADC     $Div, $Div, $Div ; Double $Div
      ENDFIF
      MOV     $Temp, $Temp, LSR #1 ; Halve $Temp,
      CMP     $Temp, $Bot        ; and loop until
      BHS    %b91              ; less than divisor
      MEND

```

The macro checks that no two parameters use the same register. It also optimizes the code produced if only the remainder is required.

To avoid multiple definitions of labels if DivMod is used more than once in the assembler source, the macro uses numeric local labels (90, 91).

The following example shows the code that this macro produces if it is invoked as follows:

```
ratio DivMod R0,R5,R4,R2
```

Output from the example division macro

```

ratio  ASSERT r5 <> r4      ; Produce an error if the
      ASSERT r5 <> r2      ; registers supplied are
      ASSERT r4 <> r2      ; not all different
      ASSERT r0 <> r5      ; These three only matter if $Div
      ASSERT r0 <> r4      ; is not null ("")
      ASSERT r0 <> r2      ;
      MOV     r2, r4        ; Put divisor in $Temp
      CMP     r2, r5, LSR #1 ; double it until
90     MOVLS  r2, r2, LSL #1 ; 2 * r2 > r5
      CMP     r2, r5, LSR #1

```

```
91      BLS      %b90      ; The b means search backwards
        MOV      r0, #0      ; Initialize quotient
        CMP      r5, r2      ; Can we subtract r2?
        SUBCS   r5, r5, r2    ; If we can, do so
        ADC      r0, r0, r0    ; Double r0
        MOV      r2, r2, LSR #1 ; Halve r2,
        CMP      r2, r4      ; and loop until
        BHS      %b91      ; less than divisor
```

Related concepts

[4.21 Use of macros on page 4-90.](#)

[4.22 Test-and-branch macro example on page 4-91.](#)

[7.10 Numeric local labels on page 7-147.](#)

4.24 Instruction and directive relocations

The assembler can embed relocation directives in object files to indicate labels with addresses that are unknown at assembly time. The assembler can relocate several types of instruction.

A relocation is a directive embedded in the object file that enables source code to refer to a label whose target address is unknown or cannot be calculated at assembly time. The assembler emits a relocation in the object file, and the linker resolves this to the address where the target is placed.

The assembler relocates the data directives DCB, DCW, DCWU, DCD, and DCDU if their syntax contains an external symbol, that is a symbol declared using IMPORT or EXTERN. This causes the bottom 8, 16, or 32 bits of the address to be used at link-time.

The REQUIRE directive emits a relocation to signal to the linker that the target label must be present if the current section is present.

The assembler is permitted to emit a relocation for these instructions:

LDR (PC-relative)

All ARM and Thumb instructions, except the Thumb doubleword instruction, can be relocated.

PLD, PLDW, and PLI

All ARM and Thumb instructions can be relocated.

B, BL, and BLX

All ARM and Thumb instructions can be relocated.

CBZ and CBNZ

All Thumb instructions can be relocated but this is discouraged because of the limited branch range of these instructions.

LDC and LDC2

Only ARM instructions can be relocated.

VLDR

Only ARM instructions can be relocated.

Wireless MMX load instructions

Only ARM word and doubleword load instructions can be relocated.

The assembler emits a relocation for these instructions if the label used meets any of the following requirements, as appropriate for the instruction type:

- The label is WEAK.
- The label is not in the same AREA.
- The label is external to the object (IMPORT or EXTERN).

For B, BL, and BX instructions, the assembler emits a relocation also if:

- The label is a function.
- The label is exported using EXPORT or GLOBAL.

Note

You can use the RELOC directive to control the relocation at a finer level, but this requires knowledge of the ABI.

Example

```

IMPORT sym    ; sym is an external symbol
DCW sym      ; Because DCW only outputs 16 bits, only the lower
              ; 16 bits of the address of sym are inserted at
              ; link-time.

```

Related references

[15.6 AREA on page 15-767.](#)

[15.27 EXPORT or GLOBAL on page 15-790.](#)

- 15.45 IMPORT and EXTERN on page 15-810.*
- 15.58 REQUIRE on page 15-828.*
- 15.57 RELOC on page 15-827.*
- 15.15 DCB on page 15-778.*
- 15.16 DCD and DCDU on page 15-779.*
- 15.22 DCW and DCWU on page 15-785.*
- 11.43 LDR (PC-relative) on page 11-377.*
- 11.11 ADR (PC-relative) on page 11-325.*
- 11.74 PLD, PLDW, and PLI on page 11-427.*
- 11.16 B on page 11-335.*
- 11.25 CBZ and CBNZ on page 11-349.*
- 11.40 LDC and LDC2 on page 11-370.*
- 13.12 VLDR (floating-point) on page 13-726.*
- 14.4 Wireless MMX load and store instructions on page 14-753.*

Related information

ELF for the ARM Architecture.

4.25 Symbol versions

The ARM linker conforms to the Base Platform ABI for the ARM Architecture (BPABI) and supports the GNU-extended symbol versioning model.

To add a symbol version to an existing symbol, you must define a version symbol at the same address. A version symbol is of the form:

- `name@ver` if `ver` is a non default version of `name`.
- `name@@ver` if `ver` is the default version of `name`.

The version symbols must be enclosed in vertical bars.

For example, to define a default version:

```
|my_versioned_symbol@ver2| ; Default version
my_asm_function PROC
    ...
    BX lr
ENDP
```

To define a non default version:

```
|my_versioned_symbol@ver1| ; Non default version
my_old_asm_function PROC
    ...
    BX lr
ENDP
```

Related information

[Base Platform ABI for the ARM Architecture.](#)

[Accessing and managing symbols with armlink.](#)

4.26 Frame directives

Frame directives provide information in object files that enables debugging and profiling of assembly language functions.

You must use frame directives to describe the way that your code uses the stack if you want to be able to do either of the following:

- Debug your application using stack unwinding.
- Use either flat or call-graph profiling.

The assembler uses frame directives to insert DWARF debug frame information into the object file in ELF format that it produces. This information is required by a debugger for stack unwinding and for profiling.

Be aware of the following:

- Frame directives do not affect the code produced by the assembler.
- The assembler does not validate the information in frame directives against the instructions emitted.

Related concepts

[4.27 Exception tables and Unwind tables on page 4-98.](#)

Related references

[15.3 About frame directives on page 15-763.](#)

Related information

[Procedure Call Standard for the ARM Architecture.](#)

4.27 Exception tables and Unwind tables

You use `FRAME` directives to enable the assembler to generate *unwind* tables.

Exception tables are necessary to handle exceptions thrown by functions in high-level languages such as C++. Unwind tables contain debug frame information which is also necessary for the handling of such exceptions. An exception can only propagate through a function with an unwind table.

An assembly language function is code enclosed by either `PROC` and `ENDP` or `FUNC` and `ENDFUNC` directives. Functions written in C++ have unwind information by default. However, for assembly language functions that are called from C++ code, you must ensure that there are exception tables and unwind tables to enable the exceptions to propagate through them.

An exception cannot propagate through a function with a *nounwind* table. The exception handling runtime environment terminates the program if it encounters a nounwind table during exception processing.

The assembler can generate nounwind table entries for all functions and non-functions. The assembler can generate an unwind table for a function only if the function contains sufficient `FRAME` directives to describe the use of the stack within the function. To be able to create an unwind table for a function, each `POP` or `PUSH` instruction must be followed by a `FRAME POP` or `FRAME PUSH` directive respectively. Functions must conform to the conditions set out in the *Exception Handling ABI for the ARM Architecture* (EHABI), section 9.1 *Constraints on Use*. If the assembler cannot generate an unwind table it generates a nounwind table.

Related concepts

[4.26 Frame directives on page 4-97.](#)

Related references

[15.3 About frame directives on page 15-763.](#)

[10.30 --exceptions, --no_exceptions on page 10-255.](#)

[10.31 --exceptions_unwind, --no_exceptions_unwind on page 10-256.](#)

[15.39 FRAME UNWIND ON on page 15-803.](#)

[15.40 FRAME UNWIND OFF on page 15-804.](#)

[15.41 FUNCTION or PROC on page 15-805.](#)

[15.24 ENDFUNC or ENDP on page 15-787.](#)

Related information

[Exception Handling ABI for the ARM Architecture.](#)

4.28 Assembly language changes after RVCT v2.1

The assembler accepts ARM and Thumb instructions written in either UAL or pre-UAL syntax. Some older versions of the assembler only accept pre-UAL syntax.

The assembly language accepted by the RVCT v2.1 assembler and earlier is called pre-UAL ARM and Thumb. In RVCT 2.2 and later, the assembler accepts both the UAL and the pre-UAL ARM and Thumb syntax. The assembler accepts the pre-UAL Thumb syntax only if it is preceded by a CODE16 directive, or if the source file is assembled with the --16 command-line option.

For the convenience of programmers who are familiar with the ARM assembly language accepted in RVCT v2.1 and earlier, the following table highlights the differences between the UAL and pre-UAL ARM assembly language syntax:

Table 4-3 Changes from earlier ARM assembly language

Change	Pre-UAL ARM syntax	Preferred UAL syntax
The default addressing mode for LDM and STM is IA	LDMIA, STMIA	LDM, STM
You can use the PUSH and POP mnemonics for full, descending stack operations in ARM in addition to Thumb.	STMFD <i>sp!</i> , { <i>reglist</i> } LDMFD <i>sp!</i> , { <i>reglist</i> }	PUSH { <i>reglist</i> } POP { <i>reglist</i> }
You can use the LSL, LSR, ASR, ROR, and RRX instruction mnemonics for instructions with rotations and no other operation, in ARM in addition to Thumb.	MOV <i>Rd</i> , <i>Rn</i> , LSL <i>shift</i> MOV <i>Rd</i> , <i>Rn</i> , LSR <i>shift</i> MOV <i>Rd</i> , <i>Rn</i> , ASR <i>shift</i> MOV <i>Rd</i> , <i>Rn</i> , ROR <i>shift</i> MOV <i>Rd</i> , <i>Rn</i> , RRX	LSL <i>Rd</i> , <i>Rn</i> , <i>shift</i> LSR <i>Rd</i> , <i>Rn</i> , <i>shift</i> ASR <i>Rd</i> , <i>Rn</i> , <i>shift</i> ROR <i>Rd</i> , <i>Rn</i> , <i>shift</i> RRX <i>Rd</i> , <i>Rn</i>
Use the <i>label</i> form for PC-relative addressing. Do not use the <i>offset</i> form in new code.	LDR <i>Rd</i> , [<i>pc</i> , # <i>offset</i>]	LDR <i>Rd</i> , <i>label</i>
Specify both registers for doubleword memory accesses. You must still obey rules about the register combinations you can use.	LDRD <i>Rd</i> , <i>addr_mode</i>	LDRD <i>Rd</i> , <i>Rd2</i> , <i>addr_mode</i>
{ <i>cond</i> }, if used, is always the last element of all instructions.	ADD{ <i>cond</i> }S LDR{ <i>cond</i> }SB	ADDS{ <i>cond</i> } LDRSB{ <i>cond</i> }

In addition, some flexibility is permitted that was not permitted in previous assemblers as the following table shows:

Table 4-4 Relaxation of requirements

Relaxation	Permitted syntax	Preferred syntax
If the destination register is the same as the first operand, you can use a two register form of the instruction.	ADD <i>r1</i> , <i>r3</i>	ADD <i>r1</i> , <i>r1</i> , <i>r3</i>

You can write source code for Thumb processors earlier than ARMv6T2 using UAL.

If you are writing Thumb code for a processor earlier than ARMv6T2, you must restrict yourself to instructions that are available on the processor. The assembler generates error messages if you attempt to use an instruction that is not available.

If you are writing Thumb code for an ARMv6T2 or later processor, you can minimize your code size by using 16-bit instructions wherever possible.

The following table shows the main differences between the UAL and the pre-UAL Thumb assembly language:

Table 4-5 Differences between pre-UAL Thumb syntax and UAL syntax

Change	Pre-UAL Thumb syntax	UAL syntax
The default addressing mode for LDM and STM is IA	LDMIA, STMIA	LDM, STM
You must use the S postfix on instructions that update the flags. This change is essential to avoid conflict with 32-bit Thumb instructions.	<pre>ADD r1, r2, r3 SUB r4, r5, #6 MOV r0, #1 LSR r1, r2, #1</pre>	<pre>ADDS r1, r2, r3 SUBS r4, r5, #6 MOVS r0, #1 LSRS r1, r2, #1</pre>
The preferred form for ALU instructions specifies three registers, even if the destination register is the same as the first operand. However, the UAL syntax allows the two register syntax.	<pre>ADD r7, r8 SUB r1, #80</pre>	<pre>ADD r7, r7, r8 SUBS r1, r1, #80</pre>
If <i>Rd</i> and <i>Rn</i> are both Lo registers, <code>MOV <i>Rd</i>, <i>Rn</i></code> is disassembled as <code>ADDS <i>Rd</i>, <i>Rn</i>, #0</code> .	<pre>MOV r2, r3 MOV r8, r9 CPY r0, r1 LSL r2, r3, #0</pre>	<pre>ADDS r2, r3, #0 MOV r8, r9 MOV r0, r1 MOVS r2, r3</pre>
<code>NEG <i>Rd</i>, <i>Rm</i></code> is disassembled as <code>RSBS <i>Rd</i>, <i>Rm</i>, #0</code> .	<code>NEG <i>Rd</i>, <i>Rm</i></code>	<code>RSBS <i>Rd</i>, <i>Rm</i>, #0</code>
When using the <code>LDR <i>Rd</i>,=const</code> literal load pseudo-instruction, in pre-UAL syntax, the generated instruction might affect the condition code flags. In UAL syntax, the generated instruction sequence is guaranteed to not affect the condition code flags.	<pre>LDR r0,=0 ; generates the instruction: MOVS r0,#0</pre>	<pre>LDR r0,=0 ; generates the sequence: LDR r0,{pc}+n ... DCD 0</pre>

Related references

[15.7 ARM or CODE32 on page 15-770.](#)

[15.11 CODE16 on page 15-774.](#)

[10.1 --16 on page 10-223.](#)

Chapter 5

Condition Codes

Describes condition codes and the conditional execution of ARM and Thumb code.

It contains the following sections:

- *5.1 Conditional instructions* on page 5-102.
- *5.2 Conditional execution in ARM state* on page 5-103.
- *5.3 Conditional execution in Thumb state* on page 5-104.
- *5.4 Updates to the condition flags* on page 5-105.
- *5.5 Condition code suffixes and related flags* on page 5-106.
- *5.6 Comparison of condition code meanings in integer and floating-point code* on page 5-107.
- *5.7 Benefits of using conditional execution* on page 5-109.
- *5.8 Example showing the benefits of using conditional instructions* on page 5-110.
- *5.9 Optimization for execution speed* on page 5-113.

5.1 Conditional instructions

ARM and Thumb instructions can execute conditionally on the condition flags set by a previous instruction.

The conditional instruction can occur either:

- Immediately after the instruction that updated the flags.
- After any number of intervening instructions that have not updated the flags.

The instructions that you can make conditional depends on whether the processor is in ARM state or Thumb state.

To make an instruction conditional, you must add a condition code suffix to the instruction mnemonic. The condition code suffix enables the processor to test a condition based on the flags. If the condition test of a conditional instruction fails, the instruction:

- Does not execute.
- Does not write any value to its destination register.
- Does not affect any of the flags.
- Does not generate any exception.

Related concepts

[5.4 Updates to the condition flags on page 5-105.](#)

[5.2 Conditional execution in ARM state on page 5-103.](#)

[5.3 Conditional execution in Thumb state on page 5-104.](#)

Related references

[5.5 Condition code suffixes and related flags on page 5-106.](#)

5.2 Conditional execution in ARM state

To execute ARM instructions conditionally you can either append a two letter suffix to the mnemonic, or you can use a conditional branch instruction.

Almost all ARM instructions can be executed conditionally on the value of the condition flags in the APSR. You can either add a condition code suffix to the instruction or you can conditionally skip over the instruction using a conditional branch instruction.

Using conditional branch instructions to control the flow of execution can be more efficient when a series of instructions depend on the same condition.

Example conditional instructions to control execution

```
; flags set by a previous instruction
LSLEQ r0, r0, #24
ADDEQ r0, r0, #2
;...
```

Example conditional branch to control execution

```
; flags set by a previous instruction
BNE over
LSL r0, r0, #24
ADD r0, r0, #2
over
;...
```

Related concepts

[5.3 Conditional execution in Thumb state on page 5-104.](#)

5.3 Conditional execution in Thumb state

To execute Thumb instructions conditionally, you can either use an IT instruction, or a conditional branch instruction.

In Thumb state on processors before ARMv6T2, the only mechanism for conditional execution is a conditional branch. You can conditionally skip over the instruction using a conditional branch instruction.

In Thumb state on ARMv6T2 or later processors, instructions can also be conditionally executed by using any of the following:

- CBZ and CBNZ instructions.
- The IT (If-Then) instruction.

The Thumb CBZ (Conditional Branch on Zero) and CBNZ (Conditional Branch on Non-Zero) instructions compare the value of a register against zero and branch on the result.

IT is a 16-bit instruction that enables almost all Thumb instructions to be conditionally executed, based on the value of the condition flags and the condition code suffix specified. Each IT instruction provides conditional execution for up to four following instructions.

Example conditional instructions using IT block

```
; flags set by a previous instruction
ITT   EQ
LSLEQ r0, r0, #24
ADDEQ r0, r0, #2
;...
```

Related concepts

[5.2 Conditional execution in ARM state on page 5-103.](#)

Related references

[11.39 IT on page 11-368.](#)

[11.25 CBZ and CBNZ on page 11-349.](#)

5.4 Updates to the condition flags

Most ARM and Thumb data processing instructions only update the condition flags if you append an S suffix to the mnemonic. These instructions can update all or a subset of the flags.

In ARM state, and in Thumb state on ARMv6T2 or later processors, most data processing instructions have an option to update the condition flags in the *Application Program Status Register* (APSR) according to the result of the operation. Instructions with the optional S suffix update the flags. Conditional instructions that are not executed have no effect on the flags.

In Thumb state on processors before ARMv6T2, most data processing instructions update the condition flags automatically according to the result of the operation. There is no option to leave the flags unchanged and not update them. Other instructions cannot update the flags.

The instruction also determines the flags that get updated. Some instructions update all flags, and some instructions only update a subset of the flags. If a flag is not updated, the original value is preserved. The description of each ARM and Thumb instruction includes the effect it has on the flags.

Note

Most instructions update the condition flags only if the S suffix is specified. The instructions CMP, CMN, TEQ, and TST always update the flags.

The condition flags are held in the APSR. They are set or cleared as follows:

N

Set to 1 when the result of the operation is negative, cleared to 0 otherwise.

Z

Set to 1 when the result of the operation is zero, cleared to 0 otherwise.

C

Set to 1 when the operation results in a carry, or when a subtraction results in no borrow, cleared to 0 otherwise.

V

Set to 1 when the operation causes overflow, cleared to 0 otherwise.

C is set in one of the following ways:

- For an addition, including the comparison instruction CMN, C is set to 1 if the addition produced a carry (that is, an unsigned overflow), and to 0 otherwise.
- For a subtraction, including the comparison instruction CMP, C is set to 0 if the subtraction produced a borrow (that is, an unsigned underflow), and to 1 otherwise.
- For non-addition/subtractions that incorporate a shift operation, C is set to the last bit shifted out of the value by the shifter.
- For other non-addition/subtractions, C is normally left unchanged, but see the individual instruction descriptions for any special cases.

Overflow occurs if the result of a signed add, subtract, or compare is greater than or equal to 2^{31} , or less than -2^{31} .

Related concepts

[5.1 Conditional instructions on page 5-102.](#)

Related references

[5.5 Condition code suffixes and related flags on page 5-106.](#)

[Chapter 11 ARM and Thumb Instructions on page 11-298.](#)

5.5 Condition code suffixes and related flags

Condition code suffixes define the conditions that must be met for the instruction to execute.

The following table shows the condition codes that you can use and the flag settings they depend on:

Table 5-1 Condition code suffixes and related flags

Suffix	Flags	Meaning
EQ	Z set	Equal
NE	Z clear	Not equal
CS or HS	C set	Higher or same (unsigned >=)
CC or LO	C clear	Lower (unsigned <)
MI	N set	Negative
PL	N clear	Positive or zero
VS	V set	Overflow
VC	V clear	No overflow
HI	C set and Z clear	Higher (unsigned >)
LS	C clear or Z set	Lower or same (unsigned <=)
GE	N and V the same	Signed >=
LT	N and V differ	Signed <
GT	Z clear, N and V the same	Signed >
LE	Z set, N and V differ	Signed <=
AL	Any	Always. This suffix is normally omitted.

The optional condition code is shown in syntax descriptions as `{cond}`. This condition is encoded in ARM instructions. For Thumb instructions, the condition is encoded in a preceding IT instruction. An instruction with a condition code is only executed if the condition flags in the APSR meet the specified condition.

In Thumb state on processors before ARMv6T2, the `{cond}` field is only permitted on certain branch instructions because there is no IT instruction on these processors.

The following is an example of conditional execution:

```

ADD    r0, r1, r2    ; r0 = r1 + r2, don't update flags
ADDS   r0, r1, r2    ; r0 = r1 + r2, and update flags
ADDSCS r0, r1, r2    ; If C flag set then r0 = r1 + r2,
                    ; and update flags
CMP    r0, r1        ; update flags based on r0-r1.
```

Related concepts

[5.1 Conditional instructions on page 5-102.](#)

[5.4 Updates to the condition flags on page 5-105.](#)

Related references

[5.6 Comparison of condition code meanings in integer and floating-point code on page 5-107.](#)

[Chapter 11 ARM and Thumb Instructions on page 11-298.](#)

5.6 Comparison of condition code meanings in integer and floating-point code

The meaning of the condition code mnemonic suffixes depends on whether the condition flags in the APSR were set by a floating-point instruction or by an ARM or Thumb data processing instruction.

This is because:

- Floating-point values are never unsigned, so the unsigned conditions are not required.
- Not-a-Number (NaN) values have no ordering relationship with numbers or with each other, so additional conditions are required to account for unordered results.

The only VFP instruction that can update the condition flags is `VCMP`. Other VFP or NEON instructions cannot modify the flags.

The `VCMP` instruction does not update the flags in the APSR directly, but updates a separate set of flags in the FPSCR. To use these flags to control conditional instructions, including conditional VFP instructions, you must first copy them into the APSR using a `VMRS` instruction:

```
VMRS APSR_nzcv, FPSCR
```

The meaning of the condition code mnemonic suffixes is shown in the following table:

Table 5-2 Condition codes

Suffix	Meaning after integer data processing instruction	Meaning after floating-point instruction
EQ	Equal	Equal
NE	Not equal	Not equal, or unordered
CS	Carry set	Greater than or equal, or unordered
HS	Unsigned higher or same	Greater than or equal, or unordered
CC	Carry clear	Less than
LO	Unsigned lower	Less than
MI	Negative	Less than
PL	Positive or zero	Greater than or equal, or unordered
VS	Overflow	Unordered (at least one NaN operand)
VC	No overflow	Not unordered
HI	Unsigned higher	Greater than, or unordered
LS	Unsigned lower or same	Less than or equal
GE	Signed greater than or equal	Greater than or equal
LT	Signed less than	Less than, or unordered
GT	Signed greater than	Greater than
LE	Signed less than or equal	Less than or equal, or unordered
AL	Always (normally omitted)	Always (normally omitted)

————— **Note** —————

The type of the instruction that last updated the condition flags determines the meaning of the condition codes.

Related concepts

5.1 Conditional instructions on page 5-102.

5.4 Updates to the condition flags on page 5-105.

Related references

5.5 Condition code suffixes and related flags on page 5-106.

13.4 VCMP, VCMPE on page 13-718.

Related information

ARM Architecture Reference Manual.

5.7 Benefits of using conditional execution

It can be more efficient to use conditional instructions rather than conditional branches.

You can use conditional execution of ARM instructions to reduce the number of branch instructions in your code. This improves code density. The IT instruction in Thumb achieves a similar improvement.

Branch instructions are also expensive in processor cycles. On ARM processors without branch prediction hardware, it typically takes three processor cycles to refill the processor pipeline each time a branch is taken.

Some ARM processors, for example the ARM Cortex-R7 processor, have branch prediction hardware. In systems using these processors, the pipeline only has to be flushed and refilled when there is a misprediction.

Related concepts

[5.8 Example showing the benefits of using conditional instructions on page 5-110.](#)

5.8 Example showing the benefits of using conditional instructions

Using conditional instructions rather than conditional branches can save both code size and cycles.

This topic illustrates the difference between using branches and using conditional instructions. It uses the Euclid algorithm for the *Greatest Common Divisor* (gcd) to demonstrate how conditional instructions improve code size and speed.

In C the gcd algorithm can be expressed as:

```
int gcd(int a, int b)
{
    while (a != b)
    {
        if (a > b)
            a = a - b;
        else
            b = b - a;
    }
    return a;
}
```

The following examples show implementations of the gcd algorithm with and without conditional instructions:

————— **Note** —————

The detailed analysis of execution speed only applies to an ARM7™ processor. The code density calculations apply to all ARM processors.

Example of conditional execution using branches in ARM code

This is an ARM code implementation of the gcd algorithm using branches, without using any other conditional instructions. Conditional execution is achieved by using conditional branches, rather than individual conditional instructions:

```
gcd    CMP    r0, r1
      BEQ    end
      BLT    less
      SUBS   r0, r0, r1 ; could be SUB r0, r0, r1 for ARM
      B     gcd
less   SUBS   r1, r1, r0 ; could be SUB r1, r1, r0 for ARM
      B     gcd
end
```

The code is seven instructions long because of the number of branches. Every time a branch is taken, the processor must refill the pipeline and continue from the new location. The other instructions and non-executed branches use a single cycle each.

The following table shows the number of cycles this implementation uses on an ARM7 processor when R0 equals 1 and R1 equals 2:

Table 5-3 Conditional branches only

R0: a	R1: b	Instruction	Cycles (ARM7)
1	2	CMP r0, r1	1
1	2	BEQ end	1 (not executed)
1	2	BLT less	3
1	2	SUB r1, r1, r0	1
1	2	B gcd	3
1	1	CMP r0, r1	1

Table 5-3 Conditional branches only (continued)

R0: a	R1: b	Instruction	Cycles (ARM7)
1	1	BEQ end	3
			Total = 13

Example of conditional execution using conditional instructions in ARM code

This is an ARM code implementation of the gcd algorithm using individual conditional instructions in ARM code. The gcd algorithm only takes four instructions:

```
gcd
    CMP     r0, r1
    SUBGT  r0, r0, r1
    SUBLE  r1, r1, r0
    BNE    gcd
```

In addition to improving code size, in most cases this code executes faster than the version that uses only branches.

The following table shows the number of cycles this implementation uses on an ARM7 processor when R0 equals 1 and R1 equals 2:

Table 5-4 All instructions conditional

R0: a	R1: b	Instruction	Cycles (ARM7)
1	2	CMP r0, r1	1
1	2	SUBGT r0,r0,r1	1 (not executed)
1	1	SUBLT r1,r1,r0	1
1	1	BNE gcd	3
1	1	CMP r0,r1	1
1	1	SUBGT r0,r0,r1	1 (not executed)
1	1	SUBLT r1,r1,r0	1 (not executed)
1	1	BNE gcd	1 (not executed)
			Total = 10

Comparing this with the example that uses only branches:

- Replacing branches with conditional execution of all instructions saves three cycles.
- Where R0 equals R1, both implementations execute in the same number of cycles. For all other cases, the implementation that uses conditional instructions executes in fewer cycles than the implementation that uses branches only.

Example of conditional execution using conditional instructions in Thumb code

In ARMv6T2 and later architectures, you can use the IT instruction to write conditional instructions in Thumb code. The Thumb code implementation of the gcd algorithm using conditional instructions is very similar to the implementation in ARM code. The implementation in Thumb code is:

```
gcd
    CMP     r0, r1
    ITE    GT
    SUBGT  r0, r0, r1
    SUBLE  r1, r1, r0
    BNE    gcd
```

This assembles equally well to ARM or Thumb code. The assembler checks the IT instructions, but omits them on assembly to ARM code.

It requires one more instruction in Thumb code (the IT instruction) than in ARM code, but the overall code size is 10 bytes in Thumb code compared with 16 bytes in ARM code.

Example of conditional execution code using branches in Thumb code

In architectures before ARMv6T2, there is no IT instruction and therefore Thumb instructions cannot be executed conditionally except for the B branch instruction. The gcd algorithm must be written with conditional branches and is very similar to the ARM code implementation using branches, without conditional instructions.

The Thumb code implementation of the gcd algorithm without conditional instructions requires seven instructions. The overall code size is 14 bytes. This is even less than the ARM implementation that uses conditional instructions, which uses 16 bytes.

In addition, on a system using 16-bit memory, this Thumb implementation runs faster than both ARM implementations because only one memory access is required for each 16-bit Thumb instruction, whereas each 32-bit ARM instruction requires two fetches.

Related concepts

[5.7 Benefits of using conditional execution on page 5-109.](#)

[5.9 Optimization for execution speed on page 5-113.](#)

Related references

[11.39 IT on page 11-368.](#)

[5.5 Condition code suffixes and related flags on page 5-106.](#)

Related information

[ARM Architecture Reference Manual.](#)

5.9 Optimization for execution speed

To optimize code for execution speed you must have detailed knowledge of the instruction timings, branch prediction logic, and cache behavior of your target system.

For more information, see the Technical Reference Manual for your processor.

Related information

ARM Architecture Reference Manual.

Further reading.

Chapter 6

Using the Assembler

Describes how to use the ARM assembler, `armasm`.

It contains the following sections:

- [6.1 *armasm* command-line syntax](#) on page 6-115.
- [6.2 Specify command-line options with an environment variable](#) on page 6-116.
- [6.3 Using `stdin` to input source code to the assembler](#) on page 6-117.
- [6.4 Built-in variables and constants](#) on page 6-118.
- [6.5 Identifying versions of `armasm` in source code](#) on page 6-122.
- [6.6 Diagnostic messages](#) on page 6-123.
- [6.7 Interlocks diagnostics](#) on page 6-124.
- [6.8 Automatic IT block generation](#) on page 6-125.
- [6.9 Thumb branch target alignment](#) on page 6-126.
- [6.10 Thumb code size diagnostics](#) on page 6-127.
- [6.11 ARM and Thumb instruction portability diagnostics](#) on page 6-128.
- [6.12 Instruction width diagnostics](#) on page 6-129.
- [6.13 Two pass assembler diagnostics](#) on page 6-130.
- [6.14 Conditional assembly](#) on page 6-131.
- [6.15 Using the C preprocessor](#) on page 6-132.
- [6.16 Address alignment](#) on page 6-134.
- [6.17 Instruction width selection in Thumb](#) on page 6-135.

6.1 *armasm* command-line syntax

You can use a command line to invoke *armasm*. You must specify an input source file and you can specify various options.

The command for invoking the assembler is:

```
armasm {options} inputfile
```

where:

options

are commands that instruct the assembler how to assemble the *inputfile*. You can invoke *armasm* with any combination of options separated by spaces. You can specify values for some options. To specify a value for an option, use either '=' (*option=value*) or a space character (*option value*).

inputfile

is an assembly source file. It must contain UAL or pre-UAL ARM or Thumb assembly language.

Note

The inline and embedded assemblers are part of the C and C++ compilers and do not use any command-line syntax for invocation. However, to pass additional assembler options when the compiler invokes *armasm* for embedded assembly, you can use the *armcc* -A option.

The assembler command line is case-insensitive, except in filenames and where specified. The assembler uses the same command-line ordering rules as the compiler. This means that if the command line contains options that conflict with each other, then the last option found always takes precedence.

Related information

[Order of compiler command-line options.](#)

[Compiler command-line options listed by group.](#)

6.2 Specify command-line options with an environment variable

The ARMCC5_ASMOPT environment variable can hold command-line options for the assembler.

The syntax is identical to the command-line syntax. The assembler reads the value of ARMCC5_ASMOPT and inserts it at the front of the command string. This means that options specified in ARMCC5_ASMOPT can be overridden by arguments on the command line.

Related concepts

[6.1 armasm command-line syntax](#) on page 6-115.

Related information

[Toolchain environment variables](#).

6.3 Using stdin to input source code to the assembler

You can use `stdin` to pipe output from another program into `armasm` or to input source code directly on the command line. This is useful if you want to test a short piece of code without having to create a file for it.

To use `stdin` to pipe output from another program into `armasm`, invoke the program and the assembler using the pipe character (`|`). Use the minus character (`-`) as the source filename to instruct the assembler to take input from `stdin`. You must specify the output filename using the `-o` option. You can specify the command-line options you want to use. For example to pipe output from `fromelf`:

```
fromelf --disassemble input.o | armasm -o output.o -
```

Note

The source code from `stdin` is stored in an internal cache that can hold up to 8 MB. You can increase this cache size using the `--maxcache` command-line option.

To use `stdin` to input source code directly on the command line:

Procedure

1. Invoke the assembler with the command-line options you want to use. Use the minus character (`-`) as the source filename to instruct the assembler to take input from `stdin`. You must specify the output filename using the `-o` option. For example:

```
armasm --bigend -o output.o -
```

2. Enter your input. For example:

```

AREA      ARMex, CODE, READONLY
          ; Name this block of code ARMex
start    ENTRY
          ; Mark first instruction to execute
          MOV     r0, #10      ; Set up parameters
          MOV     r1, #3
          ADD     r0, r0, r1   ; r0 = r0 + r1
stop     MOV     r0, #0x18    ; angel_SWIreason_ReportException
          LDR     r1, =0x20026 ; ADP_Stopped_ApplicationExit
          SVC     #0x123456    ; ARM semihosting (formerly SWI)
          END
          ; Mark end of file

```

3. Terminate your input by entering:
 - `Ctrl+Z` then `Return` on Microsoft Windows systems.
 - `Ctrl+D` on Unix-based operating systems.

Related concepts

[6.1 `armasm` command-line syntax](#) on page 6-115.

[16.1 Overview of `via` files](#) on page 16-840.

Related references

[10.46 `--maxcache=n`](#) on page 10-272.

Related information

[Rules for specifying command-line options.](#)

6.4 Built-in variables and constants

armasm defines built-in variables that hold information about, for example, the state of armasm, the command-line options used, and the target architecture or processor.

The following table lists the built-in variables defined by armasm:

Table 6-1 Built-in variables

{ARCHITECTURE}	Holds the name of the selected ARM architecture.
{AREANAME}	Holds the name of the current AREA.
{ARMASM_VERSION}	Holds an integer that increases with each version of armasm. The format of the version number is <i>PVVbbb</i> where: P is the major version. VV is the minor version. bbb is the build number.
ads\$version	Has the same value as {ARMASM_VERSION}.
{CODESIZE}	Is a synonym for {CONFIG}.
{COMMANDLINE}	Holds the contents of the command line.
{CONFIG}	Has the value 32 if the assembler is assembling ARM code, or 16 if it is assembling Thumb code.
{CPU}	Holds the name of the selected processor. The default is "ARM7TDMI". If an architecture was specified in the command-line --cpu option, {CPU} holds the value "Generic ARM".
{ENDIAN}	Has the value "big" if the assembler is in big-endian mode, or "little" if it is in little-endian mode.
{FPIC}	Has the Boolean value {True} if --apcs=/fpic is set. The default is {False}.
{FPU}	Holds the name of the selected FPU. The default is "SoftVFP".
{INPUTFILE}	Holds the name of the current source file.
{INTER}	Has the Boolean value True if --apcs=/inter is set. The default is {False}.
{LINENUM}	Holds an integer indicating the line number in the current source file.
{LINENUMUP}	When used in a macro, holds an integer indicating the line number of the current macro. The value is the same as {LINENUM} when used in a non-macro context.
{LINENUMUPPER}	When used in a macro, holds an integer indicating the line number of the top macro. The value is the same as {LINENUM} when used in a non-macro context.
{OPT}	Value of the currently-set listing option. You can use the OPT directive to save the current listing option, force a change in it, or restore its original value.
{PC} or .	Address of current instruction.
{PCSTOREOFFSET}	Is the offset between the address of the STR PC, [...] or STM Rb, {..., PC} instruction and the value of PC stored out. This varies depending on the processor or architecture specified.
{ROPI}	Has the Boolean value {True} if --apcs=/ropi is set. The default is {False}.

{RWPI}	Has the Boolean value {True} if --apcs=/rwp1 is set. The default is {False}.
{VAR} or @	Current value of the storage area location counter.

You can use built-in variables in expressions or conditions in assembly source code. For example:

```
IF {ARCHITECTURE} = "4T"
```

They cannot be set using the SETA, SETL, or SETS directives.

The built-in variable |ads\$version| must be all in lowercase. The names of the other built-in variables can be in uppercase, lowercase, or mixed, for example:

```
IF {CpU} = "Generic ARM"
```

————— **Note** —————

All built-in string variables contain case-sensitive values. Relational operations on these built-in variables do not match with strings that contain an incorrect case. Use the command-line options --cpu and --fpu to determine valid values for {CPU}, {ARCHITECTURE}, and {FPU}.

The assembler defines the built-in Boolean constants TRUE and FALSE.

Table 6-2 Built-in Boolean constants

{FALSE}	Logical constant false.
{TRUE}	Logical constant true.

The following table lists the target processor-related built-in variables that are predefined by the assembler. Where the value field is empty, the symbol is a Boolean value and the meaning column describes when its value is {TRUE}.

Table 6-3 Predefined macros

Name	Value	Meaning
{TARGET_ARCH_ARM}	num	The number of the ARM base architecture of the target processor irrespective of whether the assembler is assembling for ARM or Thumb.
{TARGET_ARCH_THUMB}	num	The number of the Thumb base architecture of the target processor irrespective of whether the assembler is assembling for ARM or Thumb. The value is defined as zero if the target does not support Thumb.
{TARGET_ARCH_XX}	–	XX represents the target architecture and its value depends on the target processor. For example, if you specify the assembler option --cpu=4T or --cpu=ARM7TDMI then {TARGET_ARCH_4T} is defined.
{TARGET_FEATURE_EXTENSION_REGISTER_COUNT}	num	The number of 64-bit extension registers available in NEON or VFP.
{TARGET_FEATURE_CLZ}	–	If the target processor supports the CLZ instruction (that is, ARMv5T and later except ARMv6-M).
{TARGET_FEATURE_DIVIDE}	–	If the target processor supports the hardware divide instructions SDIV and UDIV.
{TARGET_FEATURE_DOUBLEWORD}	–	If the target processor supports the LDRD and STRD instructions (that is, ARMv5TE and later except ARMv6-M).
{TARGET_FEATURE_DSPMUL}	–	If the DSP-enhanced multiplier (for example the SMLAx instruction) is available, for example in ARMv5TE.

Table 6-3 Predefined macros (continued)

Name	Value	Meaning
{TARGET_FEATURE_MULTIPLY}	–	If the target processor supports the long multiply instructions SMULL, SMLAL, UMULL, and UMLAL (that is, all architectures except ARMv6-M).
{TARGET_FEATURE_MULTIPROCESSING}	–	If assembling for a target processor with ARMv7 Multiprocessing Extensions.
{TARGET_FEATURE_NEON}	–	If the target processor has NEON.
{TARGET_FEATURE_NEON_FP16}	–	If the target processor has NEON with half-precision floating-point operations.
{TARGET_FEATURE_NEON_FP32}	–	If the target processor has NEON with single-precision floating-point operations.
{TARGET_FEATURE_NEON_INTEGER}	–	If the target processor has NEON with integer operations.
{TARGET_FEATURE_UNALIGNED}	–	If the target processor has support for unaligned access (that is, architectures ARMv6 and later except ARMv6-M).
{TARGET_FPU_SOFTVFP}	–	If assembling with the option <code>--fpu=SoftVFP</code> .
{TARGET_FPU_SOFTVFP_VFP}	–	If assembling for a target processor with softvfp and VFP hardware, for example <code>--fpu=SoftVFP+VFPv3</code> .
{TARGET_FPU_VFP}	–	If assembling for a target processor with VFP hardware, without using SoftVFP, for example <code>--fpu=VFPv3</code> .
{TARGET_FPU_VFPV2}	–	If assembling for a target processor with VFPv2.
{TARGET_FPU_VFPV3}	–	If assembling for a target processor with VFPv3.
{TARGET_FPU_VFPV4}	–	If assembling for a target processor with VFPv4.
{TARGET_PROFILE_A}	–	If assembling for a Cortex™-A profile processor, for example, if you specify the assembler option <code>--cpu=7-A</code> .
{TARGET_PROFILE_M}	–	If assembling for a Cortex-M profile processor, for example, if you specify the assembler option <code>--cpu=7-M</code> .
{TARGET_PROFILE_R}	–	If assembling for a Cortex-R profile processor, for example, if you specify the assembler option <code>--cpu=7-R</code> .

The following table shows the possible values for {TARGET_ARCH_ARM} and {TARGET_ARCH_THUMB}, and for *xx* in the TARGET_ARCH_XX built-in variables. It also shows how these values relate to versions of the ARM architecture.

Table 6-4 {TARGET_ARCH_ARM} in relation to {TARGET_ARCH_THUMB}

ARM architecture	{TARGET_ARCH_ARM}	{TARGET_ARCH_THUMB}	<i>xx</i>
v4	4	0	4
v4T	4	1	4T
v5T	5	2	5T
v5TE	5	2	5TE
v5TEJ	5	2	5TEJ
v6	6	3	6
v6K	6	3	6K

Table 6-4 {TARGET_ARCH_ARM} in relation to {TARGET_ARCH_THUMB} (continued)

ARM architecture	{TARGET_ARCH_ARM}	{TARGET_ARCH_THUMB}	xx
v6Z	6	3	6Z
v6T2	6	4	6T2
v6-M	0	3	6_M
v6S-M	0	3	6S_M
v7-A	7	4	7_A
v7-R	7	4	7_R
v7-M	0	4	7_M
v7E-M	0	4	7E_M

Related concepts

[6.5 Identifying versions of *armasm* in source code](#) on page 6-122.

Related references

[10.15 *--cpu=name*](#) on page 10-238.

[10.34 *--fpu=name*](#) on page 10-259.

6.5 Identifying versions of armasm in source code

The assembler defines the built-in variable `ARMASM_VERSION` to hold the version number of the assembler.

You can use it as follows:

```
IF ( {ARMASM_VERSION} / 1000000) >= 5
; using armasm in ARM Compiler 5 or above
ELSE
; using armasm in ARM Compiler 4.1 or earlier
ENDIF
```

The assembler also defines the built-in variable `|ads$version|` for legacy code. This variable did not exist before ADS and RVCT. If you have to build versions of your code using legacy development tools, you can test for the built-in variable `|ads$version|`. If this variable is not defined, then the assembler is part of a legacy development toolchain. Use code similar to the following:

```
IF :DEF: |ads$version|
; code for RealView or ADS
ELSE
; code for SDT (a legacy development toolchain)
ENDIF
```

Related references

[6.4 Built-in variables and constants on page 6-118.](#)

6.6 Diagnostic messages

The assembler can provide extra error, warning, and remark diagnostic messages in addition to the default ones.

By default, these additional diagnostic messages are not displayed. However, you can enable them using the command-line options `--diag_error`, `--diag_warning`, and `--diag_remark`.

Related concepts

[6.7 Interlocks diagnostics](#) on page 6-124.

[6.8 Automatic IT block generation](#) on page 6-125.

[6.9 Thumb branch target alignment](#) on page 6-126.

[6.10 Thumb code size diagnostics](#) on page 6-127.

[6.11 ARM and Thumb instruction portability diagnostics](#) on page 6-128.

[6.12 Instruction width diagnostics](#) on page 6-129.

[6.13 Two pass assembler diagnostics](#) on page 6-130.

Related references

[10.19 --diag_error=tag\[,tag,...\]](#) on page 10-244.

6.7 Interlocks diagnostics

armasm can report warning messages about possible interlocks in your code caused by the pipeline of the processor chosen by the `--cpu` option.

To do this, use the `--diag_warning 1563` command-line option when invoking `armasm`.

————— **Note** —————

armasm does not have an accurate model of the target processor, so these messages are not reliable when used with a multi-issue processor such as Cortex-A8.

Related concepts

[6.8 Automatic IT block generation](#) on page 6-125.

[6.9 Thumb branch target alignment](#) on page 6-126.

[6.12 Instruction width diagnostics](#) on page 6-129.

[6.6 Diagnostic messages](#) on page 6-123.

Related references

[10.23 --diag_warning=tag\[,tag,...\]](#) on page 10-248.

6.8 Automatic IT block generation

The assembler can automatically insert an IT block for conditional instructions in Thumb code, without requiring the use of explicit IT instructions.

If you write the following code:

```
AREA x, CODE
THUMB
MOVNE r0,r1
NOP
IT     NE
MOVNE r0,r1
END
```

the assembler generates the following instructions:

```
IT     NE
MOVNE r0,r1
NOP
IT     NE
MOVNE r0,r1
```

You can receive warning messages about this automatic generation of IT blocks when assembling Thumb code. To do this, use the following command-line option when invoking the assembler:

```
armasm --diag_warning 1763
```

Related concepts

[6.6 Diagnostic messages on page 6-123.](#)

Related references

[10.23 --diag_warning=tag\[,tag,...\] on page 10-248.](#)

6.9 Thumb branch target alignment

The assembler can issue warnings about non word-aligned branch targets in Thumb code.

On some processors, non word-aligned Thumb instructions sometimes take one or more additional cycles to execute in loops. This means that it can be an advantage to ensure that branch targets are word-aligned. To ensure the assembler reports such warnings, use the following command-line option when invoking the assembler:

```
armasm --diag_warning 1604
```

Related concepts

[6.6 Diagnostic messages](#) on page 6-123.

Related references

[10.23 --diag_warning=tag\[,tag,...\]](#) on page 10-248.

6.10 Thumb code size diagnostics

The assembler can issue a warning when it assembles a Thumb instruction to a 32-bit encoding when it could have used a 16-bit encoding.

In Thumb code, some instructions, for example a branch or LDR (PC-relative), can be encoded as a 32-bit or 16-bit instruction. The assembler chooses the size of the encoded instruction.

To enable this warning, use the following command-line option when invoking the assembler:

```
armasm --diag_warning 1813
```

Related concepts

[6.17 Instruction width selection in Thumb](#) on page 6-135.

[2.2 ARM, Thumb, and ThumbEE instruction sets](#) on page 2-36.

[6.6 Diagnostic messages](#) on page 6-123.

Related references

[10.23 --diag_warning=tag\[,tag,...\]](#) on page 10-248.

6.11 ARM and Thumb instruction portability diagnostics

The assembler can issue warnings about instructions that cannot assemble to both ARM and Thumb code.

There are a few UAL instructions that can assemble as either ARM code or Thumb code, but not both. You can identify these instructions in the source code using the following command-line option when invoking the assembler:

```
armasm --diag_warning 1812
```

It warns for any instruction that cannot be assembled in the other instruction set. This is only a hint, and other factors, like relocation availability or target distance might affect the accuracy of the message.

Related concepts

[2.2 ARM, Thumb, and ThumbEE instruction sets](#) on page 2-36.

[6.6 Diagnostic messages](#) on page 6-123.

Related references

[10.23 --diag_warning=tag\[,tag,...\]](#) on page 10-248.

6.12 Instruction width diagnostics

The assembler can issue a warning when it assembles a Thumb branch instruction to a 32-bit encoding when it could have used a 16-bit encoding.

If you use the `.w` specifier, the instruction is encoded in 32 bits even if it can be encoded in 16 bits. You can use a diagnostic warning to detect when a branch instruction could have been encoded in 16 bits, but has been encoded in 32 bits. To do this, use the following command-line option when invoking the assembler:

```
armasm --diag_warning 1607
```

Note

This diagnostic does not produce a warning for relocated branch instructions, because the final address is not known. The linker might even insert a veneer, if the branch is out of range for a 32-bit instruction.

Related concepts

[6.6 Diagnostic messages on page 6-123.](#)

Related references

[10.23 --diag_warning=tag\[,tag,...\] on page 10-248.](#)

6.13 Two pass assembler diagnostics

armasm can issue a warning about code that might not be identical in both assembler passes.

armasm is a two pass assembler and the input code that the assembler reads must be identical in both passes. If a symbol is defined after the `:DEF:` test for that symbol, then the code read in pass one might be different from the code read in pass two. `armasm` can warn in this situation.

To do this, use the `--diag_warning 1907` command-line option when invoking `armasm`.

Example

The following example shows that the symbol `foo` is defined after the `:DEF: foo` test.

```
AREA x, CODE
[ :DEF: foo
]
foo MOV r3, r4
END
```

Assembling this code with `--diag_warning 1907` generates the message:

```
Warning A1907W: Test for this symbol has been seen and may cause failure in the second pass.
```

Related concepts

- [6.8 Automatic IT block generation](#) on page 6-125.
- [6.9 Thumb branch target alignment](#) on page 6-126.
- [6.12 Instruction width diagnostics](#) on page 6-129.
- [6.6 Diagnostic messages](#) on page 6-123.
- [1.3 How the assembler works](#) on page 1-30.

Related references

- [10.23 --diag_warning=tag\[,tag,...\]](#) on page 10-248.
- [1.4 Directives that can be omitted in pass 2 of the assembler](#) on page 1-32.

6.14 Conditional assembly

Conditional assembly works differently from conditional compilation using the C preprocessor.

The C preprocessor performs textual transformations of macro identifiers into their definitions. Transformation occurs at the point at which the identifier is used. The C preprocessor is controlled by the following:

- Preprocessor directives embedded in the C source file, for example, `#define`.
- Compiler command-line options, for example `-D` and `-U`. These have the same effect as a `#define` or `#undef` directive at the beginning of each source file.

For example, in the following code, the C preprocessor replaces `y` with `x+1` at the point at which `y` is used, and therefore `example()` returns 0:

```
#define x 1
#define y x+1
#define x 2
int example()
{
  #if y == 2
    return 1;
  #else
    return 0;
  #endif
}
```

Conditional assembly is based on variables, and works on each line in turn. Unlike the C preprocessor, the assembler evaluates expressions. Conditional assembly is controlled by the following:

- Assembler directives that declare and set the value of variables, for example `GBLx`, `LCLx` and `SETx`.
- Assembler directives that control the flow of the assembly, for example `WHILE`, `IF` and `ELSE`.
- Assembler directives that define macros, for example `MACRO`.
- The assembler command-line option `--predefine`, which pre-executes a `GBLx` and `SETx` directive.

For example, in the following code, the assembler evaluates `x+1` at the point at which the `SETA` directive occurs, and therefore `MOV` sets `r0` to 1:

```
GBLA x
GBLA y
x SETA 1
y SETA x+1
x SETA 2
AREA example, CODE
IF y == 2
  MOV r0, #1
ELSE
  MOV r0, #0
ENDIF
END
```

Related references

[15.2 About assembly control directives on page 15-762.](#)

[10.56 --predefine "directive" on page 10-282.](#)

Related information

[-Dname\[\(parm-list\)\]\[=def\] compiler option.](#)

[-Uname compiler option.](#)

6.15 Using the C preprocessor

The assembler can invoke the compiler to preprocess an assembly language source file before assembling it. This allows you to use C preprocessor commands in assembly source code.

If you do this, you must use the `--cpreproc` command-line option when invoking the assembler. This causes `armasm` to call `armcc` to preprocess the file before assembling it.

`armasm` looks for the `armcc` binary in the same directory as the `armasm` binary. If it does not find the binary, it expects it to be on the `PATH`.

`armasm` passes certain options to `armcc` if present on the command line. These are shown in the following table:

Table 6-5 Command-line options

<code>--16</code>	<code>--bi</code>	<code>--diag_suppress</code>	<code>--li</code>
<code>--32</code>	<code>--cpu</code>	<code>--diag_warning</code>	<code>--library_type</code>
<code>--apcs</code>	<code>--diag_error</code>	<code>--fpu</code>	<code>--thumb</code>
<code>--arm</code>	<code>--diag_remark</code>	<code>--fpumode</code>	<code>--unaligned_access</code> , <code>--no_unaligned_access</code>
<code>--arm_only</code>	<code>--diag_style</code>	<code>-i</code>	

Some of the options that `armasm` passes to `armcc` are converted to the `armcc` equivalent beforehand. These are shown in the following table:

Table 6-6 armcc equivalent command-line options

armasm	armcc
<code>--16</code>	<code>--thumb</code>
<code>--32</code>	<code>--arm</code>
<code>-i</code>	<code>-I</code>

To pass other simple compiler options, such as the preprocessor option `-D`, you must use the `--cpreproc_opts` command-line option. `armasm` correctly interprets the preprocessed `#line` commands. It can generate error messages and `debug_line` tables using the information in the `#line` commands.

Preprocessing an assembly language source file

The following example shows the command you write to preprocess and assemble a file, `source.s`. The example also passes the compiler options to define a macro called `RELEASE`, and to undefine a macro called `ALPHA`.

```
armasm --cpreproc --cpreproc_opts=-D,RELEASE,-U,ALPHA source.s
```

Preprocessing an assembly language source file manually

If you want to use complex preprocessor options, you must manually call `armcc` to preprocess the file before calling `armasm`. The following example shows the commands you write to manually preprocess and assemble a file, `source.s`:

```
armcc -E source.s > preprocessed.s
armasm preprocessed.s
```

In this example, the preprocessor outputs a file called `preprocessed.s`, and `armasm` assembles it.

Related references

10.12 --cpreproc on page 10-235.

10.13 --cpreproc_opts=option[,option,...] on page 10-236.

Related information

Compiler command-line options listed by group.

6.16 Address alignment

The handling of unaligned addresses in load and store instructions depends on the ARM architecture version.

ARMv7

In ARMv7-A and ARMv7-R, the A bit in the *System Control Register*, SCTLR, controls whether alignment checking is enabled or disabled. In ARMv7-M, the UNALIGN_TRP bit, bit 3, in the *Configuration and Control Register* (CCR) controls this.

If alignment checking is enabled, all unaligned word and halfword transfers cause an alignment exception. If disabled, unaligned accesses are permitted for the LDR, LDRH, STR, STRH, LDRSH, LDRT, STRT, LDRSHT, LDRHT, STRHT, and TBH instructions. Other data-accessing instructions always cause an alignment exception for unaligned data.

For STRD and LDRD, the specified address must be word-aligned.

ARMv5 and earlier

For word transfers, you must ensure that addresses are 4-byte aligned. Otherwise, if alignment checking is enabled, an alignment exception occurs. If alignment checking is unavailable, or if it is available but disabled, the following occur:

- For STR, LDR, STM, and LDM, the specified address is rounded down to a multiple of four.
- Additionally, for LDR only:
 1. Four bytes of data are loaded from the resulting address.
 2. The loaded data is rotated right by one, two or three bytes according to bits [1:0] of the address. For a little-endian memory system, this causes the addressed byte to occupy the least significant byte of the register. For a big-endian memory system, it causes the addressed byte to occupy:
 - Bits[31:24] if bit[0] of the address is 0.
 - Bits[15:8] if bit[0] of the address is 1.

Addresses must be halfword-aligned for halfword transfers, and doubleword-aligned for doubleword transfers.

ARMv6

ARMv6 can be configured to support either the ARMv5 or ARMv7 alignment models, depending on the value of the U bit in the SCTLR. ARMv6-M faults all unaligned data accesses.

--no_unaligned_access

If all your data accesses are aligned, you can use the `--no_unaligned_access` command-line option to avoid linking in any library functions that support unaligned accesses.

Related references

[10.64 --unaligned_access, --no_unaligned_access](#) on page 10-290.

6.17 Instruction width selection in Thumb

If the assembler can select either a 16-bit or a 32-bit encoding for a Thumb instruction, in general it selects the 16-bit encoding. You can override this by specifying a `.w` or `.N` mnemonic qualifier.

If you are writing Thumb code for ARMv6T2 or later processors, some instructions can have either a 16-bit encoding or a 32-bit encoding.

If you do not specify the instruction size, by default:

- For forward reference LDR, ADR, and B instructions, the assembler always generates a 16-bit instruction, even if that results in failure for a target that could be reached using a 32-bit instruction.
- For external reference LDR and B instructions, the assembler always generates a 32-bit instruction.
- In all other cases, the assembler generates the smallest size encoding that can be output.

If you want to override this behavior, you can use the `.w` or `.N` width specifier to ensure a particular instruction size. The assembler faults if it cannot generate an instruction with the specified width.

The `.w` specifier is ignored when assembling to ARM code, so you can safely use this specifier in code that might assemble to either ARM or Thumb code. However, the `.N` specifier is faulted when assembling to ARM code.

Related concepts

[11.2 Instruction width specifiers on page 11-311.](#)

[6.10 Thumb code size diagnostics on page 6-127.](#)

Chapter 7

Symbols, Literals, Expressions, and Operators

Describes how you can use symbols to represent variables, addresses, and constants in code, and how you can combine these with operators to create numeric or string expressions.

It contains the following sections:

- [7.1 Symbol naming rules](#) on page 7-138.
- [7.2 Variables](#) on page 7-139.
- [7.3 Numeric constants](#) on page 7-140.
- [7.4 Assembly time substitution of variables](#) on page 7-141.
- [7.5 Register-relative and PC-relative expressions](#) on page 7-142.
- [7.6 Labels](#) on page 7-143.
- [7.7 Labels for PC-relative addresses](#) on page 7-144.
- [7.8 Labels for register-relative addresses](#) on page 7-145.
- [7.9 Labels for absolute addresses](#) on page 7-146.
- [7.10 Numeric local labels](#) on page 7-147.
- [7.11 Syntax of numeric local labels](#) on page 7-148.
- [7.12 String expressions](#) on page 7-149.
- [7.13 String literals](#) on page 7-150.
- [7.14 Numeric expressions](#) on page 7-151.
- [7.15 Syntax of numeric literals](#) on page 7-152.
- [7.16 Syntax of floating-point literals](#) on page 7-153.
- [7.17 Logical expressions](#) on page 7-154.
- [7.18 Logical literals](#) on page 7-155.
- [7.19 Unary operators](#) on page 7-156.
- [7.20 Binary operators](#) on page 7-157.
- [7.21 Multiplicative operators](#) on page 7-158.
- [7.22 String manipulation operators](#) on page 7-159.

- [7.23 Shift operators](#) on page 7-160.
- [7.24 Addition, subtraction, and logical operators](#) on page 7-161.
- [7.25 Relational operators](#) on page 7-162.
- [7.26 Boolean operators](#) on page 7-163.
- [7.27 Operator precedence](#) on page 7-164.
- [7.28 Difference between operator precedence in assembly language and C](#) on page 7-165.

7.1 Symbol naming rules

You must follow some rules when naming symbols in assembly language source code.

The following rules apply:

- Symbol names must be unique within their scope.
- You can use uppercase letters, lowercase letters, numeric characters, or the underscore character in symbol names. Symbol names are case-sensitive, and all characters in the symbol name are significant.
- Do not use numeric characters for the first character of symbol names, except in numeric local labels.
- Symbols must not use the same name as built-in variable names or predefined symbol names.
- If you use the same name as an instruction mnemonic or directive, use double bars to delimit the symbol name. For example:

```
||ASSERT||
```

The bars are not part of the symbol.

- You must not use the symbols `|$a|`, `|$t|`, `|$t.x|`, or `|$d|` as program labels. These are mapping symbols that mark the beginning of ARM, Thumb, ThumbEE, and data within the object file.
- Symbols beginning with the characters `$v` are mapping symbols that relate to VFP and might be output when building for a target with VFP. ARM recommends you avoid using symbols beginning with `$v` in your source code.

If you have to use a wider range of characters in symbols, for example, when working with compilers, use single bars to delimit the symbol name. For example:

```
|.text|
```

The bars are not part of the symbol. You cannot use bars, semicolons, or newlines within the bars.

Related concepts

[7.10 Numeric local labels on page 7-147.](#)

Related references

[2.11 Predeclared core register names on page 2-46.](#)

[2.12 Predeclared extension register names on page 2-47.](#)

[2.13 Predeclared XScale register names on page 2-48.](#)

[2.14 Predeclared coprocessor names on page 2-49.](#)

[6.4 Built-in variables and constants on page 6-118.](#)

7.2 Variables

You can declare numeric, logical, or string variables using assembler directives.

The value of a variable can be changed as assembly proceeds. Variables are local to the assembler. This means that in the generated code or data, every instance of the variable has a fixed value.

The type of a variable cannot be changed. Variables are one of the following types:

- Numeric.
- Logical.
- String.

The range of possible values of a numeric variable is the same as the range of possible values of a numeric constant or numeric expression.

The possible values of a logical variable are {TRUE} or {FALSE}.

The range of possible values of a string variable is the same as the range of values of a string expression.

Use the GBLA, GBLL, GBLS, LCLA, LCLL, and LCLS directives to declare symbols representing variables, and assign values to them using the SETA, SETL, and SETS directives.

Example

```

a   SETA 100
L1  MOV R1, #(a*5) ; In the object file, this is MOV R1, #500
a   SETA 200      ; Value of 'a' is 200 only after this point.
                        ; The previous instruction is always MOV R1, #500
...
    BNE L1        ; When the processor branches to L1, it executes
                        ; MOV R1, #500

```

Related concepts

[7.14 Numeric expressions](#) on page 7-151.

[7.12 String expressions](#) on page 7-149.

[7.3 Numeric constants](#) on page 7-140.

[7.17 Logical expressions](#) on page 7-154.

Related references

[15.42 GBLA, GBLL, and GBLS](#) on page 15-806.

[15.49 LCLA, LCLL, and LCLS](#) on page 15-815.

[15.63 SETA, SETL, and SETS](#) on page 15-833.

7.3 Numeric constants

You can define 32-bit numeric constants using the EQU assembler directive.

Numeric constants are 32-bit integers. You can set them using unsigned numbers in the range 0 to $2^{32}-1$, or signed numbers in the range -2^{31} to $2^{31}-1$. However, the assembler makes no distinction between $-n$ and $2^{32}-n$.

Relational operators such as \geq use the unsigned interpretation. This means that $0 > -1$ is {FALSE}.

Use the EQU directive to define constants. You cannot change the value of a numeric constant after you define it. You can construct expressions by combining numeric constants and binary operators.

Related concepts

[7.14 Numeric expressions on page 7-151.](#)

Related references

[7.15 Syntax of numeric literals on page 7-152.](#)

[15.26 EQU on page 15-789.](#)

7.4 Assembly time substitution of variables

You can assign a string variable to all or part of a line of assembly language code. A string variable can contain numeric and logical variables.

Use the variable with a \$ prefix in the places where the value is to be substituted for the variable. The dollar character instructs `armasm` to substitute the string into the source code line before checking the syntax of the line. `armasm` faults if the substituted line is larger than the source line limit.

Numeric and logical variables can also be substituted. The current value of the variable is converted to a hexadecimal string (or T or F for logical variables) before substitution.

Use a dot to mark the end of the variable name if the following character would be permissible in a symbol name. You must set the contents of the variable before you can use it.

If you require a \$ that you do not want to be substituted, use \$\$\$. This is converted to a single \$.

You can include a variable with a \$ prefix in a string. Substitution occurs in the same way as anywhere else.

Substitution does not occur within vertical bars, except that vertical bars within double quotes do not affect substitution.

Example

```

; straightforward substitution
GBLS    add4ff
;
add4ff  SETS    "ADD r4,r4,#0xFF" ; set up add4ff
        $add4ff.00 ; invoke add4ff
        ; this produces
        ADD    r4,r4,#0xFF00
; elaborate substitution
GBLS    s1
GBLS    s2
GBLS    fixup
GBLA    count
;
count   SETA    14
s1      SETS    "a$$b$count" ; s1 now has value a$b000000E
s2      SETS    "abc"
fixup   SETS    "|xy$s2.z|" ; fixup now has value |xyabcz|
|C$$code| MOV    r4,#16 ; but the label here is C$$code

```

Related references

[3.1 Syntax of source lines in assembly language on page 3-58.](#)

[7.1 Symbol naming rules on page 7-138.](#)

7.5 Register-relative and PC-relative expressions

The assembler supports PC-relative and register-relative expressions.

A register-relative expression evaluates to a named register combined with a numeric expression.

You write a PC-relative expression in source code as a label or the PC, optionally combined with a numeric expression. Some instructions can also accept PC-relative expressions in the form [PC, #number].

If you specify a label, the assembler calculates the offset from the PC value of the current instruction to the address of the label. The assembler encodes the offset in the instruction. If the offset is too large, the assembler produces an error. The offset is either added to or subtracted from the PC value to form the required address.

ARM recommends you write PC-relative expressions using labels rather than the PC because the value of the PC depends on the instruction set.

Note

- In ARM code, the value of the PC is the address of the current instruction plus 8 bytes.
 - In Thumb code:
 - For B, BL, CBNZ, and CBZ instructions, the value of the PC is the address of the current instruction plus 4 bytes.
 - For all other instructions that use labels, the value of the PC is the address of the current instruction plus 4 bytes, with bit[1] of the result cleared to 0 to make it word-aligned.
-

Example

```

LDR    r4,=data+4*n    ; n is an assembly-time variable
; code
MOV    pc,lr
data   DCD    value_0
; n-1 DCD directives
DCD    value_n        ; data+4*n points here
; more DCD directives
  
```

Related concepts

[7.6 Labels on page 7-143.](#)

Related references

[15.52 MAP on page 15-820.](#)

7.6 Labels

A label is a symbol that represents the memory address of an instruction or data.

The address can be PC-relative, register-relative, or absolute. Labels are local to the source file unless you make them global using the `EXPORT` directive.

The address given by a label is calculated during assembly. `armasm` calculates the address of a label relative to the origin of the section where the label is defined. A reference to a label within the same section can use the PC plus or minus an offset. This is called *PC-relative addressing*.

Addresses of labels in other sections are calculated at link time, when the linker has allocated specific locations in memory for each section.

Related concepts

[7.7 Labels for PC-relative addresses on page 7-144.](#)

[7.8 Labels for register-relative addresses on page 7-145.](#)

[7.9 Labels for absolute addresses on page 7-146.](#)

Related references

[3.1 Syntax of source lines in assembly language on page 3-58.](#)

[15.27 EXPORT or GLOBAL on page 15-790.](#)

7.7 Labels for PC-relative addresses

A label can represent the PC value plus or minus the offset from the PC to the label. Use these labels as targets for branch instructions, or to access small items of data embedded in code sections.

You can define PC-relative labels using a label on an instruction or on one of the data definition directives.

You can also use the section name of an AREA directive as a label for PC-relative addresses. In this case the label points to the first byte of the specified AREA. ARM does not recommend using AREA names as branch targets because when branching from ARM to Thumb state or Thumb to ARM state in this way, the processor does not change the state properly.

Related references

[15.6 AREA on page 15-767.](#)

[15.15 DCB on page 15-778.](#)

[15.16 DCD and DCDU on page 15-779.](#)

[15.18 DCFD and DCFDU on page 15-781.](#)

[15.19 DCFS and DCFSU on page 15-782.](#)

[15.20 DCI on page 15-783.](#)

[15.21 DCQ and DCQU on page 15-784.](#)

[15.22 DCW and DCWU on page 15-785.](#)

7.8 Labels for register-relative addresses

A label can represent a named register plus a numeric value. You define these labels in a storage map. They are most commonly used to access data in data sections.

You can use the EQU directive to define additional register-relative labels, based on labels defined in storage maps.

Example of storage map definitions

```
MAP    0,r9  
MAP    0xff,r9
```

Related references

[15.17 DCDO](#) on page 15-780.

[15.26 EQU](#) on page 15-789.

[15.52 MAP](#) on page 15-820.

[15.64 SPACE or FILL](#) on page 15-834.

7.9 Labels for absolute addresses

A label can represent the absolute address of code or data.

These labels are numeric constants in the range 0 to $2^{32}-1$. They address the memory directly. You can use labels to represent absolute addresses using the EQU directive. To ensure that the labels are used correctly when referenced in code, you can specify the absolute address as:

- ARM code with the ARM directive.
- Thumb code with the THUMB directive.
- Data.

Example of defining labels for absolute address

```
abc EQU 2           ; assigns the value 2 to the symbol abc
xyz EQU label+8    ; assigns the address (label+8) to the symbol xyz
fiq EQU 0x1C, ARM  ; assigns the absolute address 0x1C to the symbol fiq
                   ; and marks it as ARM code
```

Related concepts

[7.6 Labels on page 7-143.](#)

[7.7 Labels for PC-relative addresses on page 7-144.](#)

[7.8 Labels for register-relative addresses on page 7-145.](#)

Related references

[15.26 EQU on page 15-789.](#)

7.10 Numeric local labels

Numeric local labels are a type of label that you refer to by number rather than by name. They are used in a similar way to PC-relative labels, but their scope is more limited.

A numeric local label is a number in the range 0-99, optionally followed by a name. Unlike other labels, a numeric local label can be defined many times and the same number can be used for more than one numeric local label in an area.

Numeric local labels do not appear in the object file. This means that, for example, a debugger cannot set a breakpoint directly on a numeric local label, like it can for named local labels kept using the KEEP directive.

A numeric local label can be used in place of *symbol* in source lines in an assembly language module:

- On its own, that is, where there is no instruction or directive.
- On a line that contains an instruction.
- On a line that contains a code- or data-generating directive.

A numeric local label is generally used where you might use a PC-relative label.

Numeric local labels are typically used for loops and conditional code within a routine, or for small subroutines that are only used locally. They are particularly useful when you are generating labels in macros.

The scope of numeric local labels is limited by the AREA directive. Use the ROUT directive to limit the scope of numeric local labels more tightly. A reference to a numeric local label refers to a matching label within the same scope. If there is no matching label within the scope in either direction, *armasm* generates an error message and the assembly fails.

You can use the same number for more than one numeric local label even within the same scope. By default, *armasm* links a numeric local label reference to:

- The most recent numeric local label with the same number, if there is one within the scope.
- The next following numeric local label with the same number, if there is not a preceding one within the scope.

Use the optional parameters to modify this search pattern if required.

Related concepts

[7.6 Labels on page 7-143.](#)

Related references

[3.1 Syntax of source lines in assembly language on page 3-58.](#)

[7.11 Syntax of numeric local labels on page 7-148.](#)

[15.51 MACRO and MEND on page 15-817.](#)

[15.48 KEEP on page 15-814.](#)

[15.62 ROUT on page 15-832.](#)

7.11 Syntax of numeric local labels

When referring to numeric local labels you can specify how `armasm` searches for the label.

Syntax

`n[routname]` ; a numeric local label

`%[F|B][A|T]n[routname]` ; a reference to a numeric local label

where:

`n`

is the number of the numeric local label in the range 0-99.

`routname`

is the name of the current scope.

`%`

introduces the reference.

`F`

instructs `armasm` to search forwards only.

`B`

instructs `armasm` to search backwards only.

`A`

instructs `armasm` to search all macro levels.

`T`

instructs `armasm` to look at this macro level only.

Usage

If neither `F` nor `B` is specified, `armasm` searches backwards first, then forwards.

If neither `A` nor `T` is specified, `armasm` searches all macros from the current level to the top level, but does not search lower level macros.

If `routname` is specified in either a label or a reference to a label, `armasm` checks it against the name of the nearest preceding `ROUT` directive. If it does not match, `armasm` generates an error message and the assembly fails.

Related concepts

[7.10 Numeric local labels on page 7-147.](#)

Related references

[15.62 ROUT on page 15-832.](#)

7.12 String expressions

String expressions consist of combinations of string literals, string variables, string manipulation operators, and parentheses.

Characters that cannot be placed in string literals can be placed in string expressions using the `:CHR:` unary operator. Any ASCII character from 0 to 255 is permitted.

The value of a string expression cannot exceed 5120 characters in length. It can be of zero length.

Example

```
improb SETS "literal":CC:(strvar2:LEFT:4)
           ; sets the variable improb to the value "literal"
           ; with the left-most four characters of the
           ; contents of string variable strvar2 appended
```

Related concepts

[7.13 String literals](#) on page 7-150.

[7.19 Unary operators](#) on page 7-156.

[7.2 Variables](#) on page 7-139.

Related references

[7.22 String manipulation operators](#) on page 7-159.

[15.63 SETA, SETL, and SETS](#) on page 15-833.

7.13 String literals

String literals consist of a series of characters or spaces contained between double quote characters.

The length of a string literal is restricted by the length of the input line.

To include a double quote character or a dollar character within the string literal, include the character twice as a pair. For example, you must use `$$` if you require a single `$` in the string.

C string escape sequences are also enabled and can be used within the string, unless `--no_esc` is specified.

Examples

```
abc    SETS    "this string contains only one "" double quote"  
def    SETS    "this string contains only one $$ dollar symbol"
```

Related references

[3.1 Syntax of source lines in assembly language on page 3-58.](#)

[10.49 --no_esc on page 10-275.](#)

7.14 Numeric expressions

Numeric expressions consist of combinations of numeric constants, numeric variables, ordinary numeric literals, binary operators, and parentheses.

Numeric expressions can contain register-relative or program-relative expressions if the overall expression evaluates to a value that does not include a register or the PC.

Numeric expressions evaluate to 32-bit integers. You can interpret them as unsigned numbers in the range 0 to $2^{32}-1$, or signed numbers in the range -2^{31} to $2^{31}-1$. However, `armasm` makes no distinction between $-n$ and $2^{32}-n$. Relational operators such as `>=` use the unsigned interpretation. This means that `0 > -1` is `{FALSE}`.

Example

a	SETA	256*256	;	256*256 is a numeric expression
	MOV	r1,#(a*22)	;	(a*22) is a numeric expression

Related concepts

[7.20 Binary operators](#) on page 7-157.

[7.2 Variables](#) on page 7-139.

[7.3 Numeric constants](#) on page 7-140.

Related references

[7.15 Syntax of numeric literals](#) on page 7-152.

[15.63 SETA, SETL, and SETS](#) on page 15-833.

7.15 Syntax of numeric literals

Numeric literals consist of a sequence of characters, or a single character in quotes, evaluating to an integer.

They can take any of the following forms:

- *decimal-digits*.
- *0xhexadecimal-digits*.
- *&hexadecimal-digits*.
- *n_base-n-digits*.
- *'character'*.

where:

decimal-digits

Is a sequence of characters using only the digits 0 to 9.

hexadecimal-digits

Is a sequence of characters using only the digits 0 to 9 and the letters A to F or a to f.

n_

Is a single digit between 2 and 9 inclusive, followed by an underscore character.

base-n-digits

Is a sequence of characters using only the digits 0 to ($n - 1$)

character

Is any single character except a single quote. Use the standard C escape character (`\`) if you require a single quote. The character must be enclosed within opening and closing single quotes. In this case, the value of the numeric literal is the numeric code of the character.

You must not use any other characters. The sequence of characters must evaluate to an integer in the range 0 to $2^{32}-1$ (except in DCQ and DCQU directives, where the range is 0 to $2^{64}-1$).

Examples

```

a      SETA    34906
addr   DCD     0xA10E
       LDR     r4,=#1000000F
       DCD     2_11001010
c3     SETA    8_74007
       DCQ     0x0123456789abcdef
       LDR     r1,='A'      ; pseudo-instruction loading 65 into r1
       ADD     r3,r2,#'\''  ; add 39 to contents of r2, result to r3
  
```

Related concepts

[7.3 Numeric constants on page 7-140.](#)

7.16 Syntax of floating-point literals

Floating-point literals consist of a sequence of characters evaluating to a floating-point number.

They can take any of the following forms:

- `{-}digitsE{-}digits`
- `{-}{digits}.digits`
- `{-}{digits}.digitsE{-}digits`
- `0xhexdigits`
- `&hexdigits`
- `0f_hexdigits`
- `0d_hexdigits`

where:

digits

Are sequences of characters using only the digits 0 to 9. You can write E in uppercase or lowercase. These forms correspond to normal floating-point notation.

hexdigits

Are sequences of characters using only the digits 0 to 9 and the letters A to F or a to f. These forms correspond to the internal representation of the numbers in the computer. Use these forms to enter infinities and NaNs, or if you want to be sure of the exact bit patterns you are using.

The `0x` and `&` forms allow the floating-point bit pattern to be specified by any number of hex digits.

The `0f_` form requires the floating-point bit pattern to be specified by exactly 8 hex digits.

The `0d_` form requires the floating-point bit pattern to be specified by exactly 16 hex digits.

The range for single-precision floating-point values is:

- Maximum 3.40282347e+38.
- Minimum 1.17549435e-38.

The range for double-precision floating-point values is:

- Maximum 1.79769313486231571e+308.
- Minimum 2.22507385850720138e-308.

Floating-point numbers are only available if your system has VFP, or NEON with floating-point.

Examples

```
DCFD    1E308, -4E-100
DCFS    1.0
DCFS    0.02
DCFD    3.725e15
DCFS    0x7FC00000      ; Quiet NaN
DCFD    &FFF00000000000 ; Minus infinity
```

Related concepts

[7.3 Numeric constants on page 7-140.](#)

Related references

[7.15 Syntax of numeric literals on page 7-152.](#)

7.17 Logical expressions

Logical expressions consist of combinations of logical literals ({TRUE} or {FALSE}), logical variables, Boolean operators, relations, and parentheses.

Relations consist of combinations of variables, literals, constants, or expressions with appropriate relational operators.

Related references

[7.26 Boolean operators](#) on page 7-163.

[7.25 Relational operators](#) on page 7-162.

7.18 Logical literals

Logical or Boolean literals can have one of two values, {TRUE} or {FALSE}.

Related concepts

[7.13 String literals](#) on page 7-150.

Related references

[7.15 Syntax of numeric literals](#) on page 7-152.

7.19 Unary operators

Unary operators return a string, numeric, or logical value. They have higher precedence than other operators and are evaluated first.

A unary operator precedes its operand. Adjacent operators are evaluated from right to left.

The following table lists the unary operators that return strings:

Table 7-1 Unary operators that return strings

Operator	Usage	Description
:CHR:	:CHR:A	Returns the character with ASCII code A.
:LOWERCASE:	:LOWERCASE:string	Returns the given string, with all uppercase characters converted to lowercase.
:REVERSE_CC:	:REVERSE_CC:cond_code	Returns the inverse of the condition code in cond_code, or an error if cond_code does not contain a valid condition code.
:STR:	:STR:A	Returns an 8-digit hexadecimal string corresponding to a numeric expression, or the string "T" or "F" if used on a logical expression.
:UPPERCASE:	:UPPERCASE:string	Returns the given string, with all lowercase characters converted to uppercase.

The following table lists the unary operators that return numeric values:

Table 7-2 Unary operators that return numeric or logical values

Operator	Usage	Description
?	?A	Number of bytes of code generated by line defining symbol A.
+ and -	+A -A	Unary plus. Unary minus. + and – can act on numeric and PC-relative expressions.
:BASE:	:BASE:A	If A is a PC-relative or register-relative expression, :BASE: returns the number of its register component. :BASE: is most useful in macros.
:CC_ENCODING:	:CC_ENCODING:cond_code	Returns the numeric value of the condition code in cond_code, or an error if cond_code does not contain a valid condition code.
:DEF:	:DEF:A	{TRUE} if A is defined, otherwise {FALSE}.
:INDEX:	:INDEX:A	If A is a register-relative expression, :INDEX: returns the offset from that base register. :INDEX: is most useful in macros.
:LEN:	:LEN:A	Length of string A.
:LNOT:	:LNOT:A	Logical complement of A.
:NOT:	:NOT:A	Bitwise complement of A (~ is an alias, for example ~A).
:RCONST:	:RCONST:Rn	Number of register, 0-15 corresponding to R0-R15.

Related concepts

[7.20 Binary operators on page 7-157.](#)

7.20 Binary operators

You write binary operators between the pair of sub-expressions they operate on. They have lower precedence than unary operators.

————— **Note** —————

The order of precedence is not the same as in C.

Related concepts

7.28 Difference between operator precedence in assembly language and C on page 7-165.

Related references

7.21 Multiplicative operators on page 7-158.

7.22 String manipulation operators on page 7-159.

7.23 Shift operators on page 7-160.

7.24 Addition, subtraction, and logical operators on page 7-161.

7.25 Relational operators on page 7-162.

7.26 Boolean operators on page 7-163.

7.21 Multiplicative operators

Multiplicative operators have the highest precedence of all binary operators. They act only on numeric expressions.

The following table shows the multiplicative operators:

Table 7-3 Multiplicative operators

Operator	Alias	Usage	Explanation
*		A*B	Multiply
/		A/B	Divide
:MOD:	%	A:MOD:B	A modulo B

You can use the :MOD: operator on PC-relative expressions to ensure code is aligned correctly. These alignment checks have the form *PC-relative*:MOD:*Constant*. For example:

```

AREA x, CODE
ASSERT ({PC}:MOD:4) == 0
DCB 1
y DCB 2
ASSERT (y:MOD:4) == 1
ASSERT ({PC}:MOD:4) == 2
END

```

Related concepts

[7.20 Binary operators on page 7-157.](#)

[7.5 Register-relative and PC-relative expressions on page 7-142.](#)

[7.14 Numeric expressions on page 7-151.](#)

Related references

[7.15 Syntax of numeric literals on page 7-152.](#)

7.22 String manipulation operators

You can use string manipulation operators to concatenate two strings, or to extract a substring.

The following table shows the string manipulation operators. In CC, both A and B must be strings. In the slicing operators LEFT and RIGHT:

- A must be a string.
- B must be a numeric expression.

Table 7-4 String manipulation operators

Operator	Usage	Explanation
:CC:	A:CC:B	B concatenated onto the end of A
:LEFT:	A:LEFT:B	The left-most B characters of A
:RIGHT:	A:RIGHT:B	The right-most B characters of A

Related concepts

[7.12 String expressions on page 7-149.](#)

[7.14 Numeric expressions on page 7-151.](#)

7.23 Shift operators

Shift operators act on numeric expressions, by shifting or rotating the first operand by the amount specified by the second.

The following table shows the shift operators:

Table 7-5 Shift operators

Operator	Alias	Usage	Explanation
:ROL:		A:ROL:B	Rotate A left by B bits
:ROR:		A:ROR:B	Rotate A right by B bits
:SHL:	<<	A:SHL:B	Shift A left by B bits
:SHR:	>>	A:SHR:B	Shift A right by B bits

————— **Note** —————

SHR is a logical shift and does not propagate the sign bit.

—————

Related concepts

[7.20 Binary operators on page 7-157.](#)

7.24 Addition, subtraction, and logical operators

Addition, subtraction, and logical operators act on numeric expressions.

Logical operations are performed bitwise, that is, independently on each bit of the operands to produce the result.

The following table shows the addition, subtraction, and logical operators:

Table 7-6 Addition, subtraction, and logical operators

Operator	Alias	Usage	Explanation
+		A+B	Add A to B
-		A-B	Subtract B from A
:AND:	&	A:AND:B	Bitwise AND of A and B
:EOR:	^	A:EOR:B	Bitwise Exclusive OR of A and B
:OR:		A:OR:B	Bitwise OR of A and B

The use of | as an alias for :OR: is deprecated.

Related concepts

[7.20 Binary operators on page 7-157.](#)

7.25 Relational operators

Relational operators act on two operands of the same type to produce a logical value.

The operands can be one of:

- Numeric.
- PC-relative.
- Register-relative.
- Strings.

Strings are sorted using ASCII ordering. String A is less than string B if it is a leading substring of string B, or if the left-most character in which the two strings differ is less in string A than in string B.

Arithmetic values are unsigned, so the value of $0 > -1$ is {FALSE}.

The following table shows the relational operators:

Table 7-7 Relational operators

Operator	Alias	Usage	Explanation
=	==	A=B	A equal to B
>		A>B	A greater than B
>=		A>=B	A greater than or equal to B
<		A<B	A less than B
<=		A<=B	A less than or equal to B
/=	<> !=	A/=B	A not equal to B

Related concepts

[7.20 Binary operators on page 7-157.](#)

7.26 Boolean operators

Boolean operators perform standard logical operations on their operands. They have the lowest precedence of all operators.

In all three cases, both A and B must be expressions that evaluate to either {TRUE} or {FALSE}.

The following table shows the Boolean operators:

Table 7-8 Boolean operators

Operator	Alias	Usage	Explanation
:LAND:	&&	A:LAND:B	Logical AND of A and B
:LEOR:		A:LEOR:B	Logical Exclusive OR of A and B
:LOR:		A:LOR:B	Logical OR of A and B

Related concepts

[7.20 Binary operators on page 7-157.](#)

7.27 Operator precedence

armasm includes an extensive set of operators for use in expressions. It evaluates them using a strict order of precedence.

Many of the operators resemble their counterparts in high-level languages such as C.

armasm evaluates operators in the following order:

1. Expressions in parentheses are evaluated first.
2. Operators are applied in precedence order.
3. Adjacent unary operators are evaluated from right to left.
4. Binary operators of equal precedence are evaluated from left to right.

Related concepts

[7.19 Unary operators](#) on page 7-156.

[7.20 Binary operators](#) on page 7-157.

[7.28 Difference between operator precedence in assembly language and C](#) on page 7-165.

Related references

[7.21 Multiplicative operators](#) on page 7-158.

[7.22 String manipulation operators](#) on page 7-159.

[7.23 Shift operators](#) on page 7-160.

[7.24 Addition, subtraction, and logical operators](#) on page 7-161.

[7.25 Relational operators](#) on page 7-162.

[7.26 Boolean operators](#) on page 7-163.

7.28 Difference between operator precedence in assembly language and C

armasm does not follow exactly the same order of precedence when evaluating operators as a C compiler.

For example, `(1 + 2 :SHR: 3)` evaluates as `(1 + (2 :SHR: 3)) = 1` in assembly language. The equivalent expression in C evaluates as `((1 + 2) >> 3) = 0`.

ARM recommends you use brackets to make the precedence explicit.

If your code contains an expression that would parse differently in C, and you are not using the `--unsafe` option, `armasm` gives a warning:

```
A1466W: Operator precedence means that expression would evaluate differently in C
```

In the following tables:

- The highest precedence operators are at the top of the list.
- The highest precedence operators are evaluated first.
- Operators of equal precedence are evaluated from left to right.

The following table shows the order of precedence of operators in assembly language, and a comparison with the order in C.

Table 7-9 Operator precedence in ARM assembly language

assembly language precedence	equivalent C operators
unary operators	unary operators
* / :MOD:	* / %
string manipulation	n/a
:SHL: :SHR: :ROR: :ROL:	<< >>
+ - :AND: :OR: :EOR:	+ - & ^
= > >= < <= /= <>	== > >= < <= !=
:LAND: :LOR: :LEOR:	&&

The following table shows the order of precedence of operators in C.

Table 7-10 Operator precedence in C

C precedence
unary operators
* / %
+ - (as binary operators)
<< >>
< <= > >=
== !=
&
^
&&

Related concepts

[7.20 Binary operators](#) on page 7-157.

Related references

[7.27 Operator precedence](#) on page 7-164.

Chapter 8

NEON Programming

Describes the assembly programming of NEON hardware.

It contains the following sections:

- *8.1 Architecture support for NEON* on page 8-168.
- *8.2 Half-precision extension for NEON* on page 8-169.
- *8.3 Fused Multiply-Add extension for NEON* on page 8-170.
- *8.4 Extension register bank mapping in NEON* on page 8-171.
- *8.5 NEON views of the extension register bank* on page 8-173.
- *8.6 Load values to NEON registers* on page 8-174.
- *8.7 Conditional execution of NEON instructions* on page 8-175.
- *8.8 Floating-point exceptions in NEON* on page 8-176.
- *8.9 NEON data types* on page 8-177.
- *8.10 Extended notation extension for NEON* on page 8-178.
- *8.11 NEON vectors* on page 8-179.
- *8.12 Normal, long, wide, and narrow NEON operation* on page 8-180.
- *8.13 Saturating NEON instructions* on page 8-181.
- *8.14 NEON scalars* on page 8-182.
- *8.15 Polynomial arithmetic over $\{0,1\}$* on page 8-183.
- *8.16 NEON system registers* on page 8-184.
- *8.17 Flush-to-zero mode in NEON* on page 8-185.
- *8.18 NEON operations not affected by flush-to-zero mode* on page 8-186.
- *8.19 When to use flush-to-zero mode in NEON* on page 8-187.
- *8.20 The effects of using flush-to-zero mode in NEON* on page 8-188.

8.1 Architecture support for NEON

NEON technology is an optional extension to the ARM architecture. There are versions that provide additional instructions.

The NEON extension is optionally available only for the ARMv7-A and ARMv7-R architectures. All NEON instructions, with the exception of half-precision and fused multiply-add instructions, are available on systems that support NEON. Some of these instructions are also available on systems that implement the VFP extension without NEON. These are called shared instructions.

NEON instructions, including the half-precision and fused multiply-add instructions, are treated as Undefined Instructions on systems that do not support the necessary architecture extension. Even on systems that support NEON, the instructions are undefined if the necessary coprocessors are not enabled in the Coprocessor Access Control Register (CP15 CPACR).

Related concepts

[8.2 Half-precision extension for NEON on page 8-169.](#)

[8.3 Fused Multiply-Add extension for NEON on page 8-170.](#)

[9.16 VFP vector mode on page 9-207.](#)

Related information

[Floating-point support.](#)

[Further reading.](#)

8.2 Half-precision extension for NEON

The Half-precision extension optionally extends the NEON architecture.

It provides NEON instructions that perform conversion between single-precision (32-bit) and half-precision (16-bit) floating-point numbers.

The half-precision instructions are only available on NEON systems that implement the half-precision extension.

Related concepts

[8.1 Architecture support for NEON](#) on page 8-168.

[9.1 Architecture support for VFP](#) on page 9-191.

8.3 Fused Multiply-Add extension for NEON

The Fused Multiply-Add extension optionally extends the NEON architecture.

It provides NEON instructions that perform multiply and accumulate operations with a single rounding step, so suffers from less loss of accuracy than performing a multiplication followed by an add.

The fused multiply-add instructions are only available on NEON systems that implement the fused multiply-add extension.

Related concepts

[8.1 Architecture support for NEON](#) on page 8-168.

[9.1 Architecture support for VFP](#) on page 9-191.

8.4 Extension register bank mapping in NEON

The NEON extension register bank is a collection of registers that can be accessed as either 64-bit or 128-bit registers.

The NEON extension register bank is distinct from the ARM register bank.

The following figure shows the three views of the extension register bank, and the overlap between the different size registers. For example, the 128-bit register Q8 is an alias for 2 consecutive 64-bit registers D16 and D17.

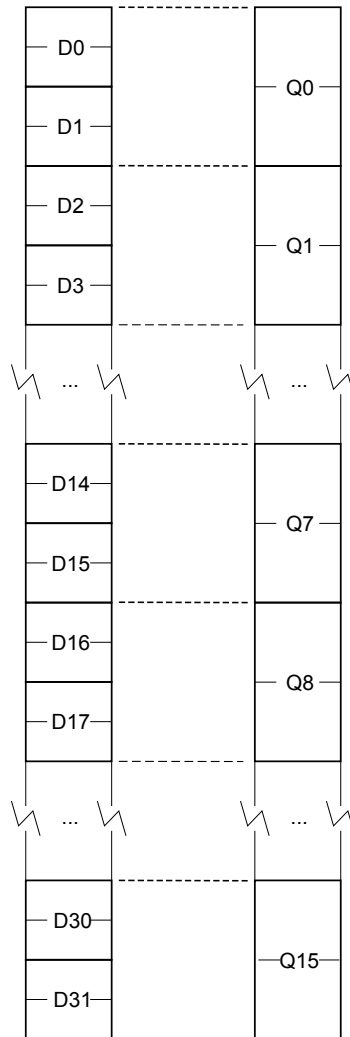

Figure 8-1 NEON extension register bank

The aliased views enable half-precision, single-precision, double-precision values, and NEON vectors to coexist in different non-overlapped registers at the same time.

You can also use the same overlapped registers to store half-precision, single-precision, and double-precision values, and NEON vectors at different times.

Do not attempt to use overlapped 64-bit and 128-bit registers at the same time because it creates meaningless results.

The mapping between the registers is as follows:

- $D\langle 2n \rangle$ maps to the least significant half of $Q\langle n \rangle$.
- $D\langle 2n+1 \rangle$ maps to the most significant half of $Q\langle n \rangle$.

For example, you can access the least significant half of the elements of a vector in Q6 by referring to D12, and the most significant half of the elements by referring to D13.

Related concepts

[8.5 NEON views of the extension register bank on page 8-173.](#)

[9.5 VFP views of the extension register bank on page 9-196.](#)

8.5 NEON views of the extension register bank

NEON technology can view the extension register bank as sixteen 128-bit registers, or as thirty-two 64-bit registers, or as a combination of registers from these views.

The 128-bit registers are Q0-Q15. The 64-bit registers are D0-D31.

NEON technology views each register as containing a *vector* of 1, 2, 4, 8, or 16 elements, all of the same size and type. Individual elements can also be accessed as *scalars*.

In NEON technology, the 64-bit registers are called doubleword registers and the 128-bit registers are called quadword registers.

Related concepts

[8.4 Extension register bank mapping in NEON on page 8-171.](#)

[9.5 VFP views of the extension register bank on page 9-196.](#)

8.6 Load values to NEON registers

There are different ways to load immediate values into NEON registers.

In NEON technology, the `VMOV` and `VMVN` instructions load a limited range of floating-point immediate values.

The NEON `VMOV` and `VMVN` instructions can also load integer immediates.

You can load any 64-bit integer, single-precision, or double-precision floating-point value from a literal pool, in a single instruction, using the `VLDR` pseudo-instruction.

Related references

[12.46 VLDR pseudo-instruction](#) on page 12-625.

[12.56 VMOV \(floating-point\)](#) on page 12-635.

[12.57 VMOV \(immediate\)](#) on page 12-636.

8.7 Conditional execution of NEON instructions

Most NEON instructions always execute unconditionally.

In ARM state, except for the instructions that are common to both VFP and NEON, you cannot use a condition code to control the execution of NEON instructions.

In Thumb state, you can use an IT instruction to set condition codes on up to four following NEON instructions. However, ARM deprecates the use of any NEON instruction that does not also exist in VFP, in an IT block.

Related concepts

[5.2 Conditional execution in ARM state on page 5-103.](#)

[5.3 Conditional execution in Thumb state on page 5-104.](#)

Related references

[5.6 Comparison of condition code meanings in integer and floating-point code on page 5-107.](#)

[11.8 Condition code suffixes on page 11-319.](#)

8.8 Floating-point exceptions in NEON

The NEON extension records floating-point exceptions in the FPSCR cumulative flags.

It records the following exceptions:

Invalid operation

The exception is caused if the result of an operation has no mathematical value or cannot be represented.

Division by zero

The exception is caused if a divide operation has a zero divisor and a dividend that is not zero, an infinity or a NaN.

Overflow

The exception is caused if the absolute value of the result of an operation, produced after rounding, is greater than the maximum positive normalized number for the destination precision.

Underflow

The exception is caused if the absolute value of the result of an operation, produced before rounding, is less than the minimum positive normalized number for the destination precision, and the rounded result is inexact.

Inexact

The exception is caused if the result of an operation is not equivalent to the value that would be produced if the operation were performed with unbounded precision and exponent range.

Input denormal

The exception is caused if a denormalized input operand is replaced in the computation by a zero.

The descriptions of NEON instructions that can cause floating-point exceptions include a subsection listing the exceptions. If there is no such subsection, that instruction cannot cause any floating-point exception. See also the Technical Reference Manual for your processor.

Related concepts

[8.17 Flush-to-zero mode in NEON on page 8-185.](#)

Related references

[Chapter 12 NEON Instructions on page 12-571.](#)

Related information

[ARM Architecture Reference Manual.](#)

[Further reading.](#)

8.9 NEON data types

Most NEON instructions use a data type specifier to define the size and type of data that the instruction operates on.

Data type specifiers in NEON instructions usually consist of a letter indicating the type of data, followed by a number indicating the width. They are separated from the instruction mnemonic by a point.

The following table shows the data type specifiers available in NEON instructions:

Table 8-1 NEON data type specifiers

	8-bit	16-bit	32-bit	64-bit
Unsigned integer	U8	U16	U32	U64
Signed integer	S8	S16	S32	S64
Integer of unspecified type	I8	I16	I32	I64
Floating-point number	not available	F16	F32 (or F)	not available
Polynomial over {0,1}	P8	P16	not available	not available

The data type of the second (or only) operand is specified in the instruction.

Note

- Most instructions have a restricted range of permitted data types. See the instruction pages for details. However, the data type description is flexible:
 - If the description specifies I, you can also use S or U data types.
 - If only the data size is specified, you can specify a type (I, S, U, P or F).
 - If no data type is specified, you can specify a data type.
 - The F16 data type is only available on systems that implement the half-precision architecture extension.
-

Related concepts

[9.9 VFP data types on page 9-200.](#)

[8.15 Polynomial arithmetic over {0,1} on page 8-183.](#)

8.10 Extended notation extension for NEON

The assembler supports an extension to the architectural NEON assembly syntax, called extended notation. This allows you to define register names that include data type specifiers or scalar indexes, for convenience.

If you use extended notation, you do not have to include the data type or scalar index information in every instruction.

Register names can be any of the following:

Untyped

The register name specifies the register, but not what datatype it contains, nor any index to a particular scalar within the register.

Untyped with scalar index

The register name specifies the register, but not what datatype it contains, It specifies an index to a particular scalar within the register.

Typed

The register name specifies the register, and what datatype it contains, but not any index to a particular scalar within the register.

Typed with scalar index

The register name specifies the register, what datatype it contains, and an index to a particular scalar within the register.

Use the DN and QN directives to define names for typed and scalar registers.

Related concepts

[8.11 NEON vectors](#) on page 8-179.

[8.9 NEON data types](#) on page 8-177.

[8.14 NEON scalars](#) on page 8-182.

Related references

[15.56 QN, DN, and SN](#) on page 15-825.

8.11 NEON vectors

NEON registers holding more than one element of the same size and type are called vectors. NEON technology supports 64-bit doubleword vectors and 128-bit quadword vectors.

An operand in a NEON instruction can be a vector or a scalar.

The size of the elements in a NEON vector is defined by the data type specifier appended to the instruction mnemonic.

Doubleword vectors can contain:

- Eight 8-bit elements.
- Four 16-bit elements.
- Two 32-bit elements.
- One 64-bit element.

Quadword vectors can contain:

- Sixteen 8-bit elements.
- Eight 16-bit elements.
- Four 32-bit elements.
- Two 64-bit elements.

Related concepts

[8.14 NEON scalars](#) on page 8-182.

[8.4 Extension register bank mapping in NEON](#) on page 8-171.

[8.10 Extended notation extension for NEON](#) on page 8-178.

[8.9 NEON data types](#) on page 8-177.

[8.12 Normal, long, wide, and narrow NEON operation](#) on page 8-180.

8.12 Normal, long, wide, and narrow NEON operation

Many NEON data processing instructions are available in long, wide, and narrow variants. In long, wide, and narrow operation, the result vector is a different width from one or both operand vectors.

Normal operation

The operands are either doubleword or quadword vectors. The result vector is the same width, and usually the same type, as the operand vectors, for example:

```
VADD.I16 D0, D1, D2
```

You can specify that the operands and result of a normal instruction must all be quadwords by appending a Q to the instruction mnemonic. If you do this, the assembler produces an error if the operands or result are not quadwords.

Long operation

The operands are doubleword vectors and the result is a quadword vector. The elements of the result are usually twice the width of the elements of the operands, and the same type.

Long operation is specified using an L appended to the instruction mnemonic, for example:

```
VADDL.S16 Q0, D2, D3
```

Wide operation

One operand vector is doubleword and the other is quadword. The result vector is quadword. The elements of the result and the first operand are twice the width of the elements of the second operand.

Wide operation is specified using a W appended to the instruction mnemonic, for example:

```
VADDW.S16 Q0, Q1, D4
```

Narrow operation

The operands are quadword vectors, and the result is a doubleword vector. The elements of the result are half the width of the elements of the operands.

Narrow operation is specified using an N appended to the instruction mnemonic, for example:

```
VADDHN.I16 D0, Q1, Q2
```

Related concepts

[8.11 NEON vectors on page 8-179.](#)

8.13 Saturating NEON instructions

Saturating instructions saturate the result to the value of the upper limit or lower limit if the result overflows or underflows.

Saturating instructions are specified using a Q prefix between the V and the instruction mnemonic.

The following table shows the ranges that NEON saturating instructions saturate to, where x is the result of the operation:

Table 8-2 NEON saturation ranges

Data type	Saturation range of x
S8	$-2^7 \leq x < 2^7$
S16	$-2^{15} \leq x < 2^{15}$
S32	$-2^{31} \leq x < 2^{31}$
S64	$-2^{63} \leq x < 2^{63}$
U8	$0 \leq x < 2^8$
U16	$0 \leq x < 2^{16}$
U32	$0 \leq x < 2^{32}$
U64	$0 \leq x < 2^{64}$

Related references

[11.7 Saturating instructions](#) on page 11-318.

8.14 NEON scalars

Some NEON instructions act on scalars in combination with vectors. NEON scalars can be 8-bit, 16-bit, 32-bit, or 64-bit.

The instruction syntax refers to the scalars using an index, x , into a doubleword vector, so that $Dm[x]$ is the x th element in vector Dm . Other than multiply instructions, instructions that access scalars can access any element in the register bank.

Multiply instructions only allow 16-bit or 32-bit scalars, and can only access the first 32 scalars in the register bank. That is, in multiply instructions:

- 16-bit scalars are restricted to registers D0-D7, with x in the range 0-3.
- 32-bit scalars are restricted to registers D0-D15, with x either 0 or 1.

Related concepts

[8.11 NEON vectors on page 8-179.](#)

[8.4 Extension register bank mapping in NEON on page 8-171.](#)

8.15 Polynomial arithmetic over $\{0,1\}$

The coefficients 0 and 1 are manipulated using the rules of Boolean arithmetic.

The following rules apply:

- $0 + 0 = 1 + 1 = 0$.
- $0 + 1 = 1 + 0 = 1$.
- $0 * 0 = 0 * 1 = 1 * 0 = 0$.
- $1 * 1 = 1$.

That is, adding two polynomials over $\{0,1\}$ is the same as a bitwise exclusive OR, and multiplying two polynomials over $\{0,1\}$ is the same as integer multiplication except that partial products are exclusive-ORed instead of being added.

Related concepts

[8.9 NEON data types on page 8-177.](#)

8.16 NEON system registers

NEON system registers are accessible in all implementations of NEON.

These registers are:

- FPSCR, the floating-point status and control register.
- FPEXC, the floating-point exception register.
- FPSID, the floating-point system ID register.

A particular implementation of NEON can have additional registers. For more information, see the Technical Reference Manual for your processor.

Note

NEON technology shares the same set of system registers as VFP.

Related concepts

[4.19 The Read-Modify-Write operation on page 4-88.](#)

Related information

[ARM Architecture Reference Manual.](#)

[Further reading.](#)

8.17 Flush-to-zero mode in NEON

Flush-to-zero mode replaces denormalized numbers with zero. This does not comply with IEEE 754 arithmetic, but in some circumstances can improve performance considerably.

Flush-to-zero mode in NEON always preserves the sign bit.

NEON always uses flush-to-zero mode.

Related concepts

[8.20 The effects of using flush-to-zero mode in NEON](#) on page 8-188.

Related references

[8.19 When to use flush-to-zero mode in NEON](#) on page 8-187.

[8.18 NEON operations not affected by flush-to-zero mode](#) on page 8-186.

8.18 NEON operations not affected by flush-to-zero mode

Some NEON instructions can be carried out on denormalized numbers even in flush-to-zero mode, without flushing the results to zero.

These instructions are as follows:

- Copy, absolute value, and negate (VMOV, VMVN, V{Q}ABS, and V{Q}NEG).
- Duplicate (VDUP).
- Swap (VSWP).
- Load and store (VLDR and VSTR).
- Load multiple and store multiple (VLDM and VSTM).
- Transfer between extension registers and ARM general-purpose registers (VMOV).

Related concepts

[8.17 Flush-to-zero mode in NEON on page 8-185.](#)

Related references

[12.7 VABS on page 12-583.](#)

[13.2 VABS \(floating-point\) on page 13-716.](#)

[12.34 VDUP on page 12-610.](#)

[12.43 VLDM on page 12-622.](#)

[12.44 VLDR on page 12-623.](#)

[12.58 VMOV \(register\) on page 12-637.](#)

[13.18 VMOV \(between one ARM register and single precision VFP\) on page 13-732.](#)

[12.59 VMOV \(between two ARM registers and a 64-bit extension register\) on page 12-638.](#)

[12.60 VMOV \(between an ARM register and a NEON scalar\) on page 12-639.](#)

[12.125 VSWP on page 12-706.](#)

8.19 When to use flush-to-zero mode in NEON

You can change between flush-to-zero mode and normal mode, depending on the requirements of different parts of your code.

You must select flush-to-zero mode if all the following are true:

- IEEE 754 compliance is not a requirement for your system.
- The algorithms you are using sometimes generate denormalized numbers.
- Your system uses support code to handle denormalized numbers.
- The algorithms you are using do not depend for their accuracy on the preservation of denormalized numbers.
- The algorithms you are using do not generate frequent exceptions as a result of replacing denormalized numbers with 0.

You select flush-to-zero mode by setting the FZ bit in the FPSCR to 1. You do this using the VMRS and VMSR instructions.

Numbers already in registers are not affected by changing mode.

8.20 The effects of using flush-to-zero mode in NEON

In flush-to-zero mode, denormalized inputs are treated as zero. Results that are too small to be represented in a normalized number are replaced with zero.

With certain exceptions, flush-to-zero mode has the following effects on floating-point operations:

- A denormalized number is treated as 0 when used as an input to a floating-point operation. The source register is not altered.
- If the result of a single-precision floating-point operation, before rounding, is in the range -2^{-126} to $+2^{-126}$, it is replaced by 0.
- If the result of a double-precision floating-point operation, before rounding, is in the range -2^{-1022} to $+2^{-1022}$, it is replaced by 0.

In flush-to-zero mode, an Input Denormal exception occurs whenever a denormalized number is used as an operand. An Underflow exception occurs when a result is flushed-to-zero.

Related concepts

[8.17 Flush-to-zero mode in NEON on page 8-185.](#)

Related references

[8.18 NEON operations not affected by flush-to-zero mode on page 8-186.](#)

Chapter 9

VFP Programming

Describes the assembly programming of VFP hardware.

It contains the following sections:

- *9.1 Architecture support for VFP* on page 9-191.
- *9.2 Half-precision extension for VFP* on page 9-192.
- *9.3 Fused Multiply-Add extension for VFP* on page 9-193.
- *9.4 Extension register bank mapping in VFP* on page 9-194.
- *9.5 VFP views of the extension register bank* on page 9-196.
- *9.6 Load values to VFP registers* on page 9-197.
- *9.7 Conditional execution of VFP instructions* on page 9-198.
- *9.8 Floating-point exceptions in VFP* on page 9-199.
- *9.9 VFP data types* on page 9-200.
- *9.10 Extended notation extension for VFP* on page 9-201.
- *9.11 VFP system registers* on page 9-202.
- *9.12 Flush-to-zero mode* on page 9-203.
- *9.13 When to use flush-to-zero mode in VFP* on page 9-204.
- *9.14 The effects of using flush-to-zero mode in VFP* on page 9-205.
- *9.15 VFP operations not affected by flush-to-zero mode* on page 9-206.
- *9.16 VFP vector mode* on page 9-207.
- *9.17 Vectors in the VFP extension register bank* on page 9-208.
- *9.18 VFP vector wrap-around* on page 9-210.
- *9.19 VFP vector stride* on page 9-211.
- *9.20 Restriction on vector length* on page 9-212.
- *9.21 Control of scalar, vector, and mixed operations* on page 9-213.
- *9.22 Overview of VFP directives and vector notation* on page 9-214.
- *9.23 Pre-UAL VFP syntax and mnemonics* on page 9-215.

- [9.24 Vector notation](#) on page 9-217.
- [9.25 VFPASSERT SCALAR](#) on page 9-218.
- [9.26 VFPASSERT VECTOR](#) on page 9-219.

9.1 Architecture support for VFP

VFP is an optional extension to the ARM architecture. There are versions that provide additional instructions.

Most VFP and the shared instructions are available in all versions of the VFP architecture. Where this is not true, the descriptions of the instructions specify the applicable VFP architecture versions.

VFPv3 has variants that do not support all VFPv3 registers and floating-point data types. VFPv3 with half-precision extension and fused multiply-add extension is called VFPv4. There is a single-precision only version of VFPv4, called FPv4-SP.

For details of the implemented VFP architecture and variant, you must always refer to the Technical Reference Manual for your processor. To get VFP, you must specify the FPU or have it implicit in the processor specified with `--cpu`.

VFP instructions, including the half-precision and fused multiply-add instructions, are treated as Undefined Instructions on systems that do not support the necessary architecture extension. Even on systems that support VFP, the instructions are undefined if the necessary coprocessors are not enabled in the Coprocessor Access Control Register (CP15 CPACR).

Related concepts

[8.2 Half-precision extension for NEON on page 8-169.](#)

[8.3 Fused Multiply-Add extension for NEON on page 8-170.](#)

[9.16 VFP vector mode on page 9-207.](#)

Related information

[Floating-point support.](#)

[Further reading.](#)

9.2 Half-precision extension for VFP

The Half-precision extension optionally extends the VFPv3 architecture.

It provides VFP instructions that perform conversion between single-precision (32-bit) and half-precision (16-bit) floating-point numbers.

The half-precision instructions are only available on VFP systems that implement the half-precision extension. The VFP variants that implement the half-precision extension are VFPv3-FP16, VFPv3-D16-FP16, and VFPv4.

9.3 Fused Multiply-Add extension for VFP

The Fused Multiply-Add extension optionally extends the VFPv3 architecture.

It provides VFP instructions that perform multiply and accumulate operations with a single rounding step, so suffers from less loss of accuracy than performing a multiplication followed by an add.

The fused multiply-add instructions are only available on VFP systems that implement the fused multiply-add extension. The VFP system that implements the fused multiply-add extension is VFPv4.

9.4 Extension register bank mapping in VFP

The VFP extension register bank is a collection of registers that can be accessed as either 32-bit or 64-bit registers.

The following figure shows the views of the VFP extension register bank, and the overlap between the different size registers. For example, the 64-bit register D0 is an alias for two consecutive 32-bit registers S0, S1.

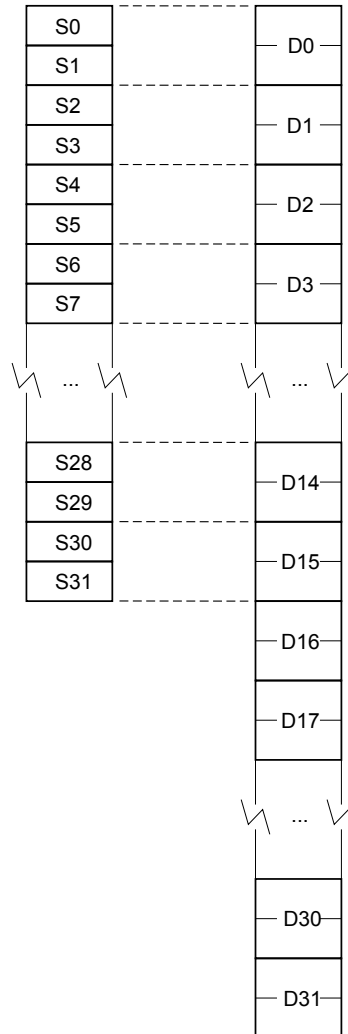

Figure 9-1 VFP extension register bank

Note

The figure applies to a VFP implementation with 32 double precision registers. The following versions of VFP use 16 double precision registers, D0-D15.

- VFPv2.
- VFPv3-D16.
- VFPv3-D16-FP16.
- VFPv4-D16.

NEON technology uses 32 double precision registers, so if your processor implements one of the VFP versions in this list, it cannot also implement NEON technology.

The aliased views enable half-precision, single-precision, and double-precision values to coexist in different non-overlapped registers at the same time.

You can also use the same overlapped registers to store half-precision, single-precision, and double-precision values at different times.

Do not attempt to use overlapped 32-bit and 64-bit registers at the same time because it creates meaningless results.

The mapping between the registers is as follows:

- $S\langle 2n \rangle$ maps to the least significant half of $D\langle n \rangle$.
- $S\langle 2n+1 \rangle$ maps to the most significant half of $D\langle n \rangle$.

For example, you can access the least significant half of the elements of a vector in $D6$ by referring to $S12$, and the most significant half of the elements by referring to $S13$.

Related concepts

[9.5 VFP views of the extension register bank on page 9-196.](#)

9.5 VFP views of the extension register bank

VFP can view the extension register bank as thirty-two 32-bit registers, or as either sixteen or thirty-two 64-bit registers, depending on the VFP version.

VFPv3, VFPv3-FP16, and VFPv4 can view the extension register bank as:

- Thirty-two 64-bit registers, D0-D31.
- Thirty-two 32-bit registers, S0-S31. Only half of the register bank is accessible in this view.
- A combination of registers from these views.

VFPv2, VFPv3-D16, VFPv3-D16-FP16, and VFPv4-D16 can view the extension register bank as:

- Sixteen 64-bit registers, D0-D15.
- Thirty-two 32-bit registers, S0-S31.
- A combination of registers from these views.

In VFP, 64-bit registers are called double-precision registers and can contain double-precision floating-point values. 32-bit registers are called single-precision registers and can contain either a single-precision or two half-precision floating-point values.

Related concepts

[8.4 Extension register bank mapping in NEON on page 8-171.](#)

[8.5 NEON views of the extension register bank on page 8-173.](#)

[9.4 Extension register bank mapping in VFP on page 9-194.](#)

9.6 Load values to VFP registers

There are different ways to load immediate values into VFP registers.

In VFPv3 and later, the *VMOV* and *VMVN* instructions load a limited range of floating-point immediate values.

You can load any 64-bit integer, single-precision, or double-precision floating-point value from a literal pool, in a single instruction, using the *VLDR* pseudo-instruction.

Related references

[13.14 *VLDR* pseudo-instruction](#) on page 13-728.

[12.56 *VMOV* \(floating-point\)](#) on page 12-635.

9.7 Conditional execution of VFP instructions

You can execute VFP instructions conditionally, in the same way as most ARM and Thumb instructions.

In ARM state, you can use a condition code to control the execution of VFP instructions. The instruction is executed conditionally, according to the status flags in the APSR, in the same way as almost all ARM instructions.

In Thumb state, you can use an IT instruction to set condition codes on up to four following VFP instructions.

Related concepts

[5.2 Conditional execution in ARM state on page 5-103.](#)

[5.3 Conditional execution in Thumb state on page 5-104.](#)

Related references

[5.6 Comparison of condition code meanings in integer and floating-point code on page 5-107.](#)

[11.8 Condition code suffixes on page 11-319.](#)

9.8 Floating-point exceptions in VFP

The VFP extension records floating-point exceptions in the FPSCR cumulative flags.

It records the following exceptions:

Invalid operation

The exception is caused if the result of an operation has no mathematical value or cannot be represented.

Division by zero

The exception is caused if a divide operation has a zero divisor and a dividend that is not zero, an infinity or a NaN.

Overflow

The exception is caused if the absolute value of the result of an operation, produced after rounding, is greater than the maximum positive normalized number for the destination precision.

Underflow

The exception is caused if the absolute value of the result of an operation, produced before rounding, is less than the minimum positive normalized number for the destination precision, and the rounded result is inexact.

Inexact

The exception is caused if the result of an operation is not equivalent to the value that would be produced if the operation were performed with unbounded precision and exponent range.

Input denormal

The exception is caused if a denormalized input operand is replaced in the computation by a zero.

The descriptions of VFP instructions that can cause floating-point exceptions include a subsection listing the exceptions. If there is no such subsection, that instruction cannot cause any floating-point exception. See also the Technical Reference Manual for your processor.

Related concepts

[9.12 Flush-to-zero mode on page 9-203.](#)

Related references

[Chapter 13 VFP Instructions on page 13-712.](#)

Related information

[ARM Architecture Reference Manual.](#)

[Further reading.](#)

9.9 VFP data types

Most VFP instructions use a data type specifier to define the size and type of data that the instruction operates on.

Data type specifiers in VFP instructions usually consist of a letter indicating the type of data, followed by a number indicating the width. They are separated from the instruction mnemonic by a point.

The following table shows the data type specifiers available in VFP instructions:

Table 9-1 VFP data type specifiers

	16-bit	32-bit	64-bit
Unsigned integer	U16	U32	not available
Signed integer	S16	S32	not available
Floating-point number	F16	F32 (or F)	F64 (or D)

The data type of the second (or only) operand is specified in the instruction.

————— **Note** —————

- Most instructions have a restricted range of permitted data types. See the instruction pages for details. However, the data type description is flexible:
 - If only the data size is specified, you can specify a type (S, U, P or F).
 - If no data type is specified, you can specify a data type.
- The F16 data type is only available on systems that implement the half-precision architecture extension.

9.10 Extended notation extension for VFP

The assembler supports an extension to the architectural VFP assembly syntax, called extended notation. This allows you to define register names that include data type specifiers or scalar indexes, for convenience.

If you use extended notation, you do not have to include the data type or scalar index information in every instruction.

Register names can be any of the following:

Untyped

The register name specifies the register, but not what datatype it contains, nor any index to a particular scalar within the register.

Untyped with scalar index

The register name specifies the register, but not what datatype it contains, It specifies an index to a particular scalar within the register.

Typed

The register name specifies the register, and what datatype it contains, but not any index to a particular scalar within the register.

Typed with scalar index

The register name specifies the register, what datatype it contains, and an index to a particular scalar within the register.

Use the SN and DN directives to define names for typed and scalar registers.

Related concepts

[9.9 VFP data types on page 9-200.](#)

Related references

[15.56 QN, DN, and SN on page 15-825.](#)

9.11 VFP system registers

Some VFP system registers are accessible in all implementations of VFP.

These registers are:

- FPSCR, the floating-point status and control register.
- FPEXC, the floating-point exception register.
- FPSID, the floating-point system ID register.

A particular implementation of VFP can have additional registers. For more information, see the Technical Reference Manual for your processor.

Related concepts

[4.19 The Read-Modify-Write operation on page 4-88.](#)

Related information

[ARM Architecture Reference Manual.](#)

[Further reading.](#)

9.12 Flush-to-zero mode

Flush-to-zero mode replaces denormalized numbers with zero. This does not comply with IEEE 754 arithmetic, but in some circumstances can improve performance considerably.

Some implementations of VFP use support code to handle denormalized numbers. The performance of such systems, in calculations involving denormalized numbers, is much less than it is in normal calculations.

In VFPv2, flush-to-zero mode can either preserve the sign bit or flush to +0, depending on the implementation. Flush-to-zero mode in VFPv3 and VFPv4 always preserves the sign bit.

Related concepts

[9.14 The effects of using flush-to-zero mode in VFP on page 9-205.](#)

Related references

[9.13 When to use flush-to-zero mode in VFP on page 9-204.](#)

[9.15 VFP operations not affected by flush-to-zero mode on page 9-206.](#)

9.13 When to use flush-to-zero mode in VFP

You can change between flush-to-zero mode and normal mode, depending on the requirements of different parts of your code.

You must select flush-to-zero mode if all the following are true:

- IEEE 754 compliance is not a requirement for your system.
- The algorithms you are using sometimes generate denormalized numbers.
- Your system uses support code to handle denormalized numbers.
- The algorithms you are using do not depend for their accuracy on the preservation of denormalized numbers.
- The algorithms you are using do not generate frequent exceptions as a result of replacing denormalized numbers with 0.

You select flush-to-zero mode by setting the FZ bit in the FPSCR to 1. You do this using the VMRS and VMSR instructions.

Numbers already in registers are not affected by changing mode.

Related concepts

[9.12 Flush-to-zero mode on page 9-203.](#)

[9.14 The effects of using flush-to-zero mode in VFP on page 9-205.](#)

9.14 The effects of using flush-to-zero mode in VFP

In flush-to-zero mode, denormalized inputs are treated as zero. Results that are too small to be represented in a normalized number are replaced with zero.

With certain exceptions, flush-to-zero mode has the following effects on floating-point operations:

- A denormalized number is treated as 0 when used as an input to a floating-point operation. The source register is not altered.
- If the result of a single-precision floating-point operation, before rounding, is in the range -2^{-126} to $+2^{-126}$, it is replaced by 0.
- If the result of a double-precision floating-point operation, before rounding, is in the range -2^{-1022} to $+2^{-1022}$, it is replaced by 0.

In flush-to-zero mode, an Input Denormal exception occurs whenever a denormalized number is used as an operand. An Underflow exception occurs when a result is flushed-to-zero.

Related concepts

[9.12 Flush-to-zero mode on page 9-203.](#)

Related references

[9.15 VFP operations not affected by flush-to-zero mode on page 9-206.](#)

9.15 VFP operations not affected by flush-to-zero mode

Some VFP instructions can be carried out on denormalized numbers even in flush-to-zero mode, without flushing the results to zero.

These instructions are as follows:

- Absolute value and negate (VABS and VNEG).
- Load and store (VLDR and VSTR).
- Load multiple and store multiple (VLDM and VSTM).
- Transfer between extension registers and ARM general-purpose registers (VMOV).

Related concepts

[9.12 Flush-to-zero mode on page 9-203.](#)

Related references

[13.2 VABS \(floating-point\) on page 13-716.](#)

[13.24 VNEG \(floating-point\) on page 13-738.](#)

[13.12 VLDR \(floating-point\) on page 13-726.](#)

[13.32 VSTR \(floating-point\) on page 13-746.](#)

[13.11 VLDM \(floating-point\) on page 13-725.](#)

[13.31 VSTM \(floating-point\) on page 13-745.](#)

[13.18 VMOV \(between one ARM register and single precision VFP\) on page 13-732.](#)

[13.19 VMOV \(between two ARM registers and one or two extension registers\) on page 13-733.](#)

9.16 VFP vector mode

VFP vector mode allows you to use VFP instructions on vectors of floating-point numbers. ARM deprecates VFP vector mode.

Usually the VFP core only works on a single register. However, many VFP arithmetic instructions can also operate on vectors of up to eight single-precision or four double-precision numbers, enabling *Single Instruction Multiple Data* (SIMD) vectorization.

In addition, the floating-point load and store instructions have multiple register forms, enabling vectors to be transferred to and from memory easily.

————— **Note** —————

ARM deprecates the use of VFP vector mode.

Related concepts

[8.1 Architecture support for NEON on page 8-168.](#)

[9.1 Architecture support for VFP on page 9-191.](#)

[9.17 Vectors in the VFP extension register bank on page 9-208.](#)

Related information

[ARM Architecture Reference Manual.](#)

9.17 Vectors in the VFP extension register bank

In VFP vector mode, the VFP extension register bank can be viewed as a collection of smaller banks. A vector consists of multiple registers from the same bank. Each of these smaller banks is treated either as a bank of 8 single-precision registers or 4 double-precision registers.

In VFPv2, VFPv3-D16, and VFPv3-D16-FP16 the VFP extension register bank can be viewed as a collection of:

- Four banks of single-precision registers, s0 to s7, s8 to s15, s16 to s23, and s24 to s31.
- Four banks of double-precision registers, d0 to d3, d4 to d7, d8 to d11, and d12 to d15.
- Any combination of single-precision and double-precision banks.

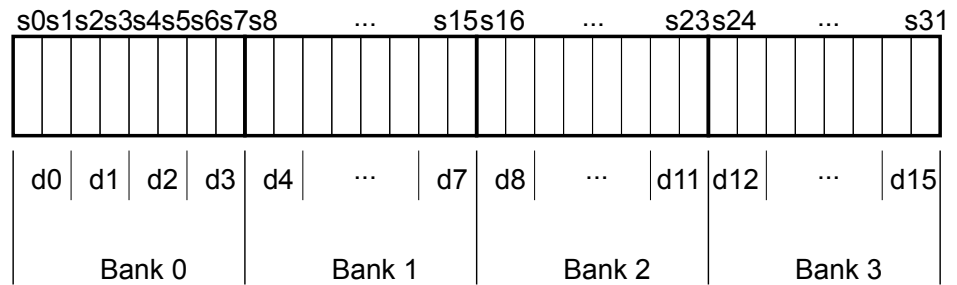

Figure 9-2 VFPv2 register banks

In VFPv3 and VFPv3-FP16, the VFP extension register bank can be viewed as a collection of:

- Four banks of single-precision registers, s0 to s7, s8 to s15, s16 to s23, and s24 to s31.
- Eight banks of double-precision registers, d0 to d3, d4 to d7, d8 to d11, d12 to d15, d16 to d19, d20 to d23, d24 to d27, and d28 to d31.
- Any combination of single-precision and double-precision banks.

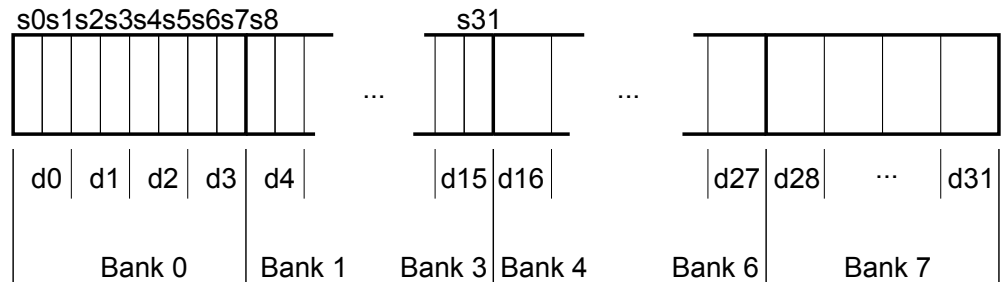

Figure 9-3 VFPv3 register banks

A vector, in a VFP instruction, can use up to eight single-precision registers, or four double-precision registers, from the same bank. The number of registers used by a vector is controlled by the LEN bits in the FPSCR.

Note

The value of the LEN bits is not a sufficient condition to perform vector operations using VFP. Whether a VFP operation is scalar, vector or mixed depends on which bank the specified operand and destination registers are in.

A vector can start from any register and wraps around to the beginning of the bank. The first register used by an operand vector is the register that is specified as the operand in the individual VFP instructions. The first register used by the destination vector is the register that is specified as the destination in the individual VFP instructions.

Related concepts

[9.18 VFP vector wrap-around on page 9-210.](#)

9.19 VFP vector stride on page 9-211.

9.20 Restriction on vector length on page 9-212.

9.21 Control of scalar, vector, and mixed operations on page 9-213.

Related information

ARM Architecture Reference Manual.

9.18 VFP vector wrap-around

In VFP vector mode, if a vector extends beyond the end of a bank, it wraps around to the beginning of the same bank.

For example:

- A vector of length 6 starting at s5 is {s5, s6, s7, s0, s1, s2}.
- A vector of length 3 starting at s15 is {s15, s8, s9}.
- A vector of length 4 starting at s22 is {s22, s23, s16, s17}.
- A vector of length 2 starting at d7 is {d7, d4}.
- A vector of length 3 starting at d10 is {d10, d11, d8}.

A vector cannot contain registers from more than one bank.

Related concepts

[9.17 Vectors in the VFP extension register bank](#) on page 9-208.

[9.20 Restriction on vector length](#) on page 9-212.

[9.19 VFP vector stride](#) on page 9-211.

Related information

ARM Architecture Reference Manual.

9.19 VFP vector stride

In VFP vector mode, vectors can occupy consecutive or alternate registers. This is controlled by the STRIDE bits in the FPSCR.

For example:

- A vector of length 3, stride 2, starting at s1, is {s1, s3, s5}.
- A vector of length 4, stride 2, starting at s6, is {s6, s0, s2, s4}.
- A vector of length 2, stride 2, starting at d1, is {d1, d3}.
- A vector of length 4, stride 1, starting at d0, is {d0, d1, d2, d3}.

Related concepts

[9.17 Vectors in the VFP extension register bank on page 9-208.](#)

[9.18 VFP vector wrap-around on page 9-210.](#)

[9.20 Restriction on vector length on page 9-212.](#)

Related information

[ARM Architecture Reference Manual.](#)

9.20 Restriction on vector length

In VFP vector mode, a vector cannot use the same register twice. This means that vector length is restricted.

Enabling for vector wrap-around, you cannot have:

- A single-precision vector with length > 4 and stride = 2.
- A double-precision vector with length > 4 and stride = 1.
- A double-precision vector with length > 2 and stride = 2.

Related concepts

[9.17 Vectors in the VFP extension register bank on page 9-208.](#)

[9.18 VFP vector wrap-around on page 9-210.](#)

Related information

[ARM Architecture Reference Manual.](#)

9.21 Control of scalar, vector, and mixed operations

Whether a VFP arithmetic instruction operates on scalars, vectors, or a mixture of both depends on the LEN bits in the FPSCR and also on which register bank the destination and operand registers are in.

Use the LEN bits in the FPSCR to control the length of vectors. When LEN is 1 all VFP operations are scalar.

When LEN is greater than 1, the VFP operation can be scalar, vector or mixed. The behavior of VFP arithmetic operations depends on which register bank the destination and operand registers are in.

The first bank of registers, s0 to s7 or d0 to d3 and the fifth bank of registers d16 to d19 are scalar banks. All other banks are vector banks. A vector operation or mixed operation is one where the destination register is in one of the vector banks.

Given instructions of the following general forms:

```
Op Fd,Fn,Fm
Op Fd,Fm
```

where:

Op is the VFP instruction.

Fd is the destination register.

Fn is an operand register.

Fm is the only or second operand register.

the behavior of the operation is as follows:

- If *Fd* is in the first or fifth bank of registers then the operation is scalar.
- If *Fm* is in the first or fifth bank of registers, but *Fd* is not, then the operation is mixed.
- If neither *Fd* nor *Fm* are in the first or fifth bank of registers, the operation is vector.

In scalar operations, *Op* acts on the value in *Fm*, and the value in *Fn* if present. The result is placed in *Fd*.

In vector operations, *Op* acts on the values in the vector starting at *Fm*, together with the values in the vector starting at *Fn* if present. The results are placed in the vector starting at *Fd*.

In mixed operations, with a single operand, *Op* acts on the single value in *Fm* and LEN copies of the result are placed in the vector starting at *Fd*.

In mixed operations, with two operands, *Op* acts on the single value in *Fm*, together with the values in the vector starting at *Fn*. The results are placed in the vector starting at *Fd*.

Related concepts

[9.17 Vectors in the VFP extension register bank on page 9-208.](#)

[9.18 VFP vector wrap-around on page 9-210.](#)

[9.19 VFP vector stride on page 9-211.](#)

[9.20 Restriction on vector length on page 9-212.](#)

Related information

[ARM Architecture Reference Manual.](#)

9.22 Overview of VFP directives and vector notation

To use vector notation, you must use pre-UAL syntax and mnemonics. You can use assembler directives to check you are using the correct syntax.

This applies only to `armasm`. The inline assemblers in the C and C++ compilers do not accept these directives or vector notation.

The use of VFP vector mode is deprecated, and vector notation is not supported in UAL. To use vector notation, you must use the pre-UAL mnemonics. You can mix pre-UAL VFP mnemonics and UAL VFP mnemonics.

You can make assertions about VFP vector lengths and strides in your code, and have them checked by the assembler, by using the following directives:

- `VFPASSERT SCALAR`.
- `VFPASSERT VECTOR`.

If you use the `VFPASSERT` directives, you must specify vector details in all VFP data processing instructions written using pre-UAL mnemonics. If you do not use the `VFPASSERT` directives you must not use this notation.

Related concepts

[9.23 Pre-UAL VFP syntax and mnemonics on page 9-215.](#)

Related references

[9.25 VFPASSERT SCALAR on page 9-218.](#)

[9.26 VFPASSERT VECTOR on page 9-219.](#)

[9.24 Vector notation on page 9-217.](#)

9.23 Pre-UAL VFP syntax and mnemonics

There are differences between pre-UAL and UAL syntax and mnemonics for VFP instructions.

Where UAL mnemonics use `.F32` to specify single-precision data, pre-UAL mnemonics use `S` appended to the instruction mnemonic. For example, `VABS.F32` was `FABS`.

Where UAL mnemonics use `.F64` to specify double-precision data, pre-UAL mnemonics use `D` appended to the instruction mnemonic. For example, `VCMPE.F64` was `FCMPED`.

Pre-UAL VFP mnemonics

The following table shows the pre-UAL mnemonics of those instructions that are affected by VFP vector mode. All other VFP instructions are always scalar regardless of the settings of `LEN` and `STRIDE`.

Table 9-2 Pre-UAL VFP mnemonics

UAL mnemonic	Equivalent pre-UAL mnemonic
VABS	FABS
VADD	FADD
VDIV	FDIV
VMLA	FMAC
VMLS	FNMAC
VMOV (immediate)	FCONST ^a
VMOV (register)	FCPY
VMUL	FMUL
VNEG	FNEG
VNMLA	FNMSC
VNMLS	FMSC
VNMUL	FNMUL
VSQRT	FSQRT
VSUB	FSUB

Immediate values in FCONST

The following table shows the floating-point values you can load using `FCONST`. Trailing zeroes are omitted for clarity. The immediate value you must put in the `FCONST` instruction is the decimal representation of the binary number `abcdefgh`, where:

a is 0 for positive numbers, or 1 for negative numbers.

bcd is shown in the column headings.

efgh is shown in the row headings.

Alternatively, you can use `0x` followed by the hexadecimal representation.

^a The immediate in `VMOV (immediate)` is the floating-point number you want to load. The immediate in `FCONST` is the number encoded in the instruction to produce the floating-point number you want to load.

Table 9-3 Floating-point values for use with FCONST

	bcd	000	001	010	011	100	101	110	111
efgh									
0000		2.0	4.0	8.0	16.0	0.125	0.25	0.5	1.0
0001		2.125	4.25	8.5	17.0	0.1328125	0.265625	0.53125	1.0625
0010		2.25	4.5	9.0	18.0	0.140625	0.28125	0.5625	1.125
0011		2.375	4.75	9.5	19.0	0.1484375	0.296875	0.59375	1.1875
0100		2.5	5.0	10.0	20.0	0.15625	0.3125	0.625	1.25
0101		2.625	5.25	10.5	21.0	0.1640625	0.328125	0.65625	1.3125
0110		2.75	5.5	11.0	22.0	0.171875	0.34375	0.6875	1.375
0111		2.875	5.75	11.5	23.0	0.1796875	0.359375	0.71875	1.4375
1000		3.0	6.0	12.0	24.0	0.1875	0.375	0.75	1.5
1001		3.125	6.25	12.5	25.0	0.1953125	0.390625	0.78125	1.5625
1010		3.25	6.5	13.0	26.0	0.203125	0.40625	0.8125	1.625
1011		3.375	6.75	13.5	27.0	0.2109375	0.421875	0.84375	1.6875
1100		3.5	7.0	14.0	28.0	0.21875	0.4375	0.875	1.75
1101		3.625	7.25	14.5	29.0	0.2265625	0.453125	0.90625	1.8125
1110		3.75	7.5	15.0	30.0	0.234375	0.46875	0.9375	1.875
1111		3.875	7.75	15.5	31.0	0.2421875	0.484375	0.96875	1.9375

9.24 Vector notation

In vector notation, you specify vectors of VFP registers using angle brackets.

You specify scalar and vector registers in pre-UAL VFP data processing instructions as follows:

- sn is a single-precision scalar register n .
- $sn<>$ is a single-precision vector whose length and stride are given by the current vector length and stride, as defined by `VFPASSERT VECTOR`. The vector starts at register n .
- $sn<L>$ is a single-precision vector of length L , stride 1. The vector starts at register n .
- $sn<L:S>$ is a single-precision vector of length L , stride S . The vector starts at register n .
- dn is a double-precision scalar register n .
- $dn<>$ is a double-precision vector whose length and stride are given by the current vector length and stride, as defined by `VFPASSERT VECTOR`. The vector starts at register n .
- $dn<L>$ is a double-precision vector of length L , stride 1. The vector starts at register n .
- $dn<L:S>$ is a double-precision vector of length L , stride S . The vector starts at register n .

You can use this vector notation with names defined using the `DN` and `SN` directives.

You must not use this vector notation in the `DN` and `SN` directives themselves.

Related references

[9.25 VFPASSERT SCALAR](#) on page 9-218.

[9.26 VFPASSERT VECTOR](#) on page 9-219.

[15.56 QN, DN, and SN](#) on page 15-825.

9.25 VFPASSERT SCALAR

The VFPASSERT SCALAR directive informs the assembler that the following VFP instructions are in scalar mode. This forces the instruction syntax to be scalar.

Syntax

```
VFPASSERT SCALAR
```

Usage

Use the VFPASSERT SCALAR directive to mark the end of any block of code where the VFP mode is VECTOR.

Place the VFPASSERT SCALAR directive immediately after the instruction where the change occurs. This is usually an FMXR instruction, but might be a BL instruction.

If a function expects VFP to be in vector mode on exit, place a VFPASSERT SCALAR directive immediately after the last instruction. Such a function would not be AAPCS compliant.

Note

This directive does not generate any code. It is only an assertion by the programmer. The assembler produces error messages if any such assertions are inconsistent with each other, or with any vector notation in VFP data processing instructions.

The assembler faults vector notation in VFP data processing instructions following a VFPASSERT SCALAR directive, even if the vector length is 1.

Example

```

VFPASSERT SCALAR      ; scalar mode
fadd      d4, d4, d0  ; okay
fadds     s4<3>, s8<3>, s0 ; ERROR, vectors in scalar mode
fabss     s24<1>, s28<1> ; ERROR, vectors in scalar mode
                                     ; (even though length==1)

```

Related references

[9.24 Vector notation on page 9-217.](#)

[9.26 VFPASSERT VECTOR on page 9-219.](#)

Related information

Procedure Call Standard for the ARM Architecture.

9.26 VFPASSERT VECTOR

The VFPASSERT VECTOR directive informs the assembler that the following VFP instructions are in vector mode. It can also specify the length and stride of the vectors.

Syntax

```
VFPASSERT VECTOR{<{n{:s}}>>}
```

where:

n
is the vector length, 1-8.

s
is the vector stride, 1-2.

Usage

Use the VFPASSERT VECTOR directive to mark the start of a block of instructions where the VFP mode is VECTOR, and to mark changes in the length or stride of vectors.

Place the VFPASSERT VECTOR directive immediately after the instruction where the change occurs. This is usually an FMXR instruction, but might be a BL instruction.

If a function expects VFP to be in vector mode on entry, place a VFPASSERT VECTOR directive immediately before the first instruction. Such a function would not be AAPCS compliant.

Note

This directive does not generate any code. It is only an assertion by the programmer. The assembler produces error messages if any such assertions are inconsistent with each other, or with any vector notation in VFP data processing instructions.

Example

```

VMRS    r10,FPSCR           ; UAL mnemonic - could be FMRX instead.
BIC     r10,r10,#0x00370000
ORR     r10,r10,#0x00200000   ; set length = 3, stride = 1
VMSR   FPSCR,r10
VFPASSERT VECTOR           ; assert vector mode, unspecified length
                          ; and stride
faddd  d4, d4, d0           ; ERROR, scalars in vector mode
fadds  s16<3>, s8<3>, s0    ; okay
fabss  s24<1>, s28<1>      ; wrong length, but not faulted
                          ; (unspecified)

VMRS    r10,FPSCR
BIC     r10,r10,#0x00370000
ORR     r10,r10,#0x00300000   ; set length = 4, stride = 1
VMSR   FPSCR,r10
VFPASSERT VECTOR<4>       ; assert vector mode, length 4, stride 1
                          ; okay
fadds  s24<4>, s8<4>, s0    ; okay
fabss  s24<2>, s24<2>      ; ERROR, wrong length

VMRS    r10,FPSCR
BIC     r10,r10,#0x00370000
ORR     r10,r10,#0x00130000   ; set length = 4, stride = 2
VMSR   FPSCR,r10
VFPASSERT VECTOR<4:2>     ; assert vector mode, length 4, stride 2
                          ; ERROR, wrong stride because omitting
                          ; stride causes a default stride of 1.
fadds  s8<4>, s16<4>, s0    ; okay
fabss  s16<4:2>, s28<4:2>  ; okay
fadds  s8<>, s16<>, s2      ; okay (s8 and s16 both have
                          ; length 4 and stride 2. s2 is scalar.)

```

Related references

[9.24 Vector notation on page 9-217.](#)

[9.25 VFPASSERT SCALAR on page 9-218.](#)

Related information

Procedure Call Standard for the ARM Architecture.

Chapter 10

Assembler Command-line Options

Describes the command-line options supported by the ARM assembler, `armasm`.

It contains the following sections:

- [10.1 --16](#) on page 10-223.
- [10.2 --32](#) on page 10-224.
- [10.3 --apcs=qualifier...qualifier](#) on page 10-225.
- [10.4 --arm](#) on page 10-227.
- [10.5 --arm_only](#) on page 10-228.
- [10.6 --bi](#) on page 10-229.
- [10.7 --bigend](#) on page 10-230.
- [10.8 --brief_diagnostics, --no_brief_diagnostics](#) on page 10-231.
- [10.9 --checkreglist](#) on page 10-232.
- [10.10 --comment_section, --no_comment_section](#) on page 10-233.
- [10.11 --compatible=name](#) on page 10-234.
- [10.12 --cpreproc](#) on page 10-235.
- [10.13 --cpreproc_opts=option\[,option,...\]](#) on page 10-236.
- [10.14 --cpu=list](#) on page 10-237.
- [10.15 --cpu=name](#) on page 10-238.
- [10.16 --debug](#) on page 10-241.
- [10.17 --depend=dependfile](#) on page 10-242.
- [10.18 --depend_format=string](#) on page 10-243.
- [10.19 --diag_error=tag\[,tag,...\]](#) on page 10-244.
- [10.20 --diag_remark=tag\[,tag,...\]](#) on page 10-245.
- [10.21 --diag_style={arm|ide|gnu}](#) on page 10-246.
- [10.22 --diag_suppress=tag\[,tag,...\]](#) on page 10-247.
- [10.23 --diag_warning=tag\[,tag,...\]](#) on page 10-248.

- 10.24 `--dllexport_all` on page 10-249.
- 10.25 `--dwarf2` on page 10-250.
- 10.26 `--dwarf3` on page 10-251.
- 10.27 `--errors=errorfile` on page 10-252.
- 10.28 `--execstack`, `--no_execstack` on page 10-253.
- 10.29 `--execute_only` on page 10-254.
- 10.30 `--exceptions`, `--no_exceptions` on page 10-255.
- 10.31 `--exceptions_unwind`, `--no_exceptions_unwind` on page 10-256.
- 10.32 `--fpmode=model` on page 10-257.
- 10.33 `--fpu=list` on page 10-258.
- 10.34 `--fpu=name` on page 10-259.
- 10.35 `-g` on page 10-261.
- 10.36 `--help` on page 10-262.
- 10.37 `-idir[,dir; ...]` on page 10-263.
- 10.38 `--keep` on page 10-264.
- 10.39 `--length=n` on page 10-265.
- 10.40 `--li` on page 10-266.
- 10.41 `--library_type=lib` on page 10-267.
- 10.42 `--list=file` on page 10-268.
- 10.43 `--list=` on page 10-269.
- 10.44 `--littleend` on page 10-270.
- 10.45 `-m` on page 10-271.
- 10.46 `--maxcache=n` on page 10-272.
- 10.47 `--md` on page 10-273.
- 10.48 `--no_code_gen` on page 10-274.
- 10.49 `--no_esc` on page 10-275.
- 10.50 `--no_hide_all` on page 10-276.
- 10.51 `--no_regs` on page 10-277.
- 10.52 `--no_terse` on page 10-278.
- 10.53 `--no_warn` on page 10-279.
- 10.54 `-o filename` on page 10-280.
- 10.55 `--pd` on page 10-281.
- 10.56 `--predefine "directive"` on page 10-282.
- 10.57 `--reduce_paths`, `--no_reduce_paths` on page 10-283.
- 10.58 `--regnames` on page 10-284.
- 10.59 `--report-if-not-wysiwyg` on page 10-285.
- 10.60 `--show_cmdline` on page 10-286.
- 10.61 `--split_ldm` on page 10-287.
- 10.62 `--thumb` on page 10-288.
- 10.63 `--thumbx` on page 10-289.
- 10.64 `--unaligned_access`, `--no_unaligned_access` on page 10-290.
- 10.65 `--unsafe` on page 10-291.
- 10.66 `--untyped_local_labels` on page 10-292.
- 10.67 `--version_number` on page 10-293.
- 10.68 `--via=filename` on page 10-294.
- 10.69 `--vsn` on page 10-295.
- 10.70 `--width=n` on page 10-296.
- 10.71 `--xref` on page 10-297.

10.1 --16

Instructs the assembler to interpret instructions as Thumb instructions using the pre-UAL Thumb syntax.

This option is equivalent to a `CODE16` directive at the head of the source file. Use the `--thumb` option to specify Thumb instructions using the UAL syntax.

Related references

[10.62 `--thumb` on page 10-288.](#)

[15.11 `CODE16` on page 15-774.](#)

10.2 --32

A synonym for the `--arm` command-line option.

Related references

[10.4 `--arm` on page 10-227](#).

10.3 --apcs=qualifier...qualifier

Controls interworking and position independence when generating code.

Syntax

--apcs=*qualifier...qualifier*

Where *qualifier...qualifier* denotes a list of qualifiers. There must be:

- At least one qualifier present.
- No spaces or commas separating individual qualifiers in the list.

Each instance of *qualifier* must be one of:

none

Specifies that the input file does not use AAPCS. AAPCS registers are not set up. Other qualifiers are not permitted if you use none.

/interwork, /nointerwork

/interwork specifies that the code in the input file can interwork between ARM and Thumb safely. The default is */nointerwork*.

/inter, /nointer

Are synonyms for */interwork* and */nointerwork*.

/ropi, /noropi

/ropi specifies that the code in the input file is *Read-Only Position-Independent (ROPI)*. The default is */noropi*.

/pic, /nopic

Are synonyms for */ropi* and */noropi*.

/rwpi, /norwpi

/rwpi specifies that the code in the input file is *Read-Write Position-Independent (RWPI)*. The default is */norwpi*.

/pid, /nopid

Are synonyms for */rwpi* and */norwpi*.

/fpic, /nofpic

/fpic specifies that the code in the input file is read-only independent and references to addresses are suitable for use in a Linux shared object. The default is */nofpic*.

/hardfp, /softfp

Requests hardware or software floating-point linkage. This enables the procedure call standard to be specified separately from the version of the floating-point hardware available through the *--fpu* option. It is still possible to specify the procedure call standard by using the *--fpu* option, but ARM recommends you use *--apcs*. If floating-point support is not permitted (for example, because *--fpu=none* is specified, or because of other means), then */hardfp* and */softfp* are ignored. If floating-point support is permitted and the *softfp* calling convention is used (*--fpu=softvfp* or *--fpu=softvfp+vfp...*), then */hardfp* gives an error.

Usage

This option specifies whether you are using the *Procedure Call Standard for the ARM Architecture (AAPCS)*. It can also specify some attributes of code sections.

The AAPCS forms part of the *Base Standard Application Binary Interface for the ARM Architecture (BSABI)* specification. By writing code that adheres to the AAPCS, you can ensure that separately compiled and assembled modules can work together.

Note

AAPCS qualifiers do not affect the code produced by *armasm*. They are an assertion by the programmer that the code in the input file complies with a particular variant of AAPCS. They cause attributes to be set in the object file produced by *armasm*. The linker uses these attributes to check compatibility of files, and to select appropriate library variants.

Example

```
armasm --apcs=/inter/ropi inputfile.s
```

Related information

--apcs=qualifier...qualifier compiler option.

Interworking ARM and Thumb.

Procedure Call Standard for the ARM Architecture.

Application Binary Interface (ABI) for the ARM Architecture.

10.4 --arm

Targets the ARM instruction set. The assembler is permitted to generate both ARM and Thumb code, but recognizes that ARM code is preferred.

This option instructs the assembler to interpret instructions as ARM instructions. It does not, however, guarantee ARM-only code in the object file. This is the default. Using this option is equivalent to specifying the ARM or CODE32 directive at the start of the source file.

Related references

[10.5 --arm_only](#) on page 10-228.

[15.7 ARM or CODE32](#) on page 15-770.

10.5 --arm_only

Enforces ARM-only code. The assembler behaves as if Thumb is absent from the target architecture.

This option instructs the assembler to only generate ARM code. This is similar to `--arm` but also has the property that the assembler does not permit the generation of any Thumb code.

Related references

[10.4 --arm](#) on page 10-227.

10.6 --bi

A synonym for the `--bigend` command-line option.

Related references

[10.7 --bigend](#) on page 10-230.

[10.44 --littleend](#) on page 10-270.

10.7 --bigend

Generates code suitable for an ARM processor using big-endian memory access.

The default is `--littleend`.

Related references

[10.44 --littleend](#) on page 10-270.

10.8 `--brief_diagnostics`, `--no_brief_diagnostics`

Enables and disables the output of brief diagnostic messages.

This option instructs the assembler whether to use a shorter form of the diagnostic output. In this form, the original source line is not displayed and the error message text is not wrapped when it is too long to fit on a single line. The default is `--no_brief_diagnostics`.

Related references

[10.19 `--diag_error=tag\[,tag,...\]` on page 10-244.](#)

[10.23 `--diag_warning=tag\[,tag,...\]` on page 10-248.](#)

10.9 --checkreglist

Instructs the `armasm` to check RLIST, LDM, and STM register lists to ensure that all registers are provided in increasing register number order.

When this option is used, `armasm` gives a warning if the registers are not listed in order.

————— **Note** —————

This option is deprecated. Use `--diag_warning 1206` instead.

Related references

[10.23 --diag_warning=tag\[,tag,...\]](#) on page 10-248.

10.10 --comment_section, --no_comment_section

Controls the inclusion of a comment section `.comment` in object files.

Usage

Use `--no_comment_section` to remove the `.comment` section, to help reduce the object file size.

Default

The default is `--comment_section`.

10.11 --compatible=name

Generates code that is compatible with multiple target architectures or processors.

Syntax

```
--compatible=name
```

Where:

name

is the name of a target processor or architecture, or None.

Processor and architecture names are not case-sensitive.

Specifying None generates code only for the processor or architecture specified by --cpu.

If multiple instances of this option are present on the command line, the last one specified overrides the previous instances. Specify --compatible=None at the end of the command line to turn off all other instances of the option.

Default

The default is None.

Usage

Using this option avoids having to reassemble the same source code for different targets.

See the following table. The valid combinations are:

- --cpu=*CPU_from_group1* --compatible=*CPU_from_group2*.
- --cpu=*CPU_from_group2* --compatible=*CPU_from_group1*.

Table 10-1 Compatible processor or architecture combinations

Group 1	ARM7TDMI, 4T
Group 2	Cortex-M0, Cortex-M1, Cortex-M3, Cortex-M4, 7-M, 6-M, 6S-M, SC300, SC000

No other combinations are permitted.

The effect is to generate code that is compatible with both --cpu and --compatible. This means that only 16-bit Thumb instructions are used. (This is the intersection of the capabilities of group 1 and group 2.)

Note

Although the generated code is compatible with multiple targets, this code might be less efficient than compiling for a single target processor or architecture.

Example

To generate code that is compatible with both the ARM7TDMI processor and the Cortex-M4 processor, specify:

```
armasm --cpu=arm7tdmi --compatible=cortex-m4 inputfile.s
```

Related references

[10.15 --cpu=name on page 10-238.](#)

10.12 --cpreproc

Instructs the assembler to call `armcc` to preprocess the input file before assembling it.

Related concepts

[6.15 Using the C preprocessor](#) on page 6-132.

Related references

[10.13 --cpreproc_opts=option\[,option,...\]](#) on page 10-236.

10.13 --cpreproc_opts=option[,option,...]

Enables the assembler to pass options to the compiler when using the C preprocessor.

Syntax

```
--cpreproc_opts=option[,option,...]
```

Where option[,option,...] is a comma-separated list of C preprocessing options.

At least one option must be specified.

Example

```
armasm --cpreproc --cpreproc_opts=-DDEBUG=1,-UALPHA inputfile.s
```

Related concepts

[6.15 Using the C preprocessor on page 6-132.](#)

Related references

[10.12 --cpreproc on page 10-235.](#)

10.14 --cpu=list

Lists the architecture and processor names that are supported by the --cpu=name option.

Syntax

--cpu=list

Related references

[10.15 --cpu=name](#) on page 10-238.

10.15 --cpu=name

Enables code generation for the selected ARM processor or architecture.

Syntax

--cpu=*name*

Where *name* is the name of a processor or architecture:

- If *name* is the name of a processor, enter it as shown on ARM data sheets, for example, ARM7TDMI, ARM1176JZ-S, MPCore.
- If *name* is the name of an architecture, it must belong to the list of architectures shown in the following table.

Processor and architecture names are not case-sensitive.

Wildcard characters are not accepted.

The following table shows the supported architectures. For a complete list of the supported architecture and processor names, specify the --cpu=list option.

Table 10-2 Supported ARM architectures

Architecture	Description
4	ARMv4 without Thumb
4T	ARMv4 with Thumb
5T	ARMv5 with Thumb and interworking
5TE	ARMv5 with Thumb, interworking, DSP multiply, and double-word instructions
5TEJ	ARMv5 with Thumb, interworking, DSP multiply, double-word instructions, and Jazelle extensions ————— Note ————— armasm cannot generate Java bytecodes.
6	ARMv6 with Thumb, interworking, DSP multiply, double-word instructions, unaligned and mixed-endian support, Jazelle, and media extensions.
6-M	ARMv6 microcontroller profile with Thumb only, plus processor state instructions.
6S-M	ARMv6 microcontroller profile with Thumb only, plus processor state instructions and OS extensions.
6K	ARMv6 with SMP extensions.
6T2	ARMv6 with Thumb (Thumb-2 technology).
6Z	ARMv6 with Security Extensions.
7	ARMv7 with Thumb (Thumb-2 technology) only, and without hardware divide.
7-A	ARMv7 application profile.
7-A.security	ARMv7-A architecture profile with the SMC instruction (formerly SMI).
7-R	ARMv7 real-time profile.
7-M	ARMv7 microcontroller profile.
7E-M	ARMv7-M architecture profile with DSP extension.

Note

- ARMv7 is not an actual ARM architecture. --cpu=7 denotes the features that are common to the ARMv7-A, ARMv7-R, and ARMv7-M architectures. By definition, any given feature used with --cpu=7 exists on the ARMv7-A, ARMv7-R, and ARMv7-M architectures.
 - 7-A.security is not an actual ARM architecture, but rather refers to 7-A plus Security Extensions.
 - The full list of supported architectures and processors depends on your license.
-

Default

armasm assumes --cpu=ARM7TDMI if you do not specify a --cpu option.

Usage

The following general points apply to processor and architecture options:

Processors

- Selecting the processor selects the appropriate architecture, *Floating-Point Unit* (FPU), and memory organization.
- The supported --cpu values include all current ARM product names or architecture versions.

Other ARM architecture-based processors, such as the Marvell Feroceon and the Marvell XScale, are also supported.

- If you specify a processor for the --cpu option, the generated code is optimized for that processor. This enables the assembler to use specific coprocessors or instruction scheduling for optimum performance.

Architectures

- If you specify an architecture name for the --cpu option, the generated code can run on any processor supporting that architecture. For example, --cpu=5TE produces code that can be used by the ARM926EJ-S processor.

FPU

- Some specifications of --cpu imply an --fpu selection. For example, when building with the --arm option, --cpu=ARM1136JF-S implies --fpu=vfpv2. Similarly, --cpu=Cortex-R4F implies --fpu=vfpv3_d16.

Note

Any explicit FPU, set with --fpu on the command line, overrides an implicit FPU.

- If no --fpu option is specified and no --cpu option is specified, --fpu=softvfp is used.

ARM/Thumb

- Specifying a processor or architecture that supports Thumb instructions, such as --cpu=ARM7TDMI, does not make the assembler generate Thumb code. It only enables features of the processor to be used, such as long multiply. Use the --thumb option to generate Thumb code, unless the processor is a Thumb-only processor, for example Cortex-M4. In this case, --thumb is not required.

————— **Note** —————

Specifying the target processor or architecture might make the generated object code incompatible with other ARM processors. For example, code generated for architecture ARMv6 might not run on an ARM920T processor, if the generated object code includes instructions specific to ARMv6. Therefore, you must choose the lowest common denominator processor suited to your purpose.

- If you are building for mixed ARM/Thumb systems for processors that support ARMv4T or ARMv5T, then you must specify the interworking option --apcs=/interwork. By default, this is enabled for processors that support ARMv5T or above.
- If you build for Thumb, that is with the --thumb option on the command line, the assembler generates as much of the code as possible using the Thumb instruction set. However, the assembler might generate ARM code for some parts of the compilation. For example, if you are generating code for a 16-bit Thumb processor and using VFP, any function containing floating-point operations is compiled for ARM.
- If the architecture only supports Thumb, you do not have to specify --thumb on the command line. For example, if building for ARMv7-M with --cpu=7-M, you do not have to specify --thumb on the command line, because ARMv7-M only supports Thumb. Similarly, ARMv6-M and other Thumb-only architectures.

Restrictions

You cannot specify both a processor and an architecture on the same command-line.

Example

```
armasm --cpu=Cortex-A17 inputfile.s
```

Related references

[10.3 --apcs=qualifier...qualifier on page 10-225.](#)

[10.11 --compatible=name on page 10-234.](#)

[10.14 --cpu=list on page 10-237.](#)

[10.34 --fpu=name on page 10-259.](#)

[10.62 --thumb on page 10-288.](#)

[10.65 --unsafe on page 10-291.](#)

Related information

[ARM Architecture Reference Manual.](#)

10.16 --debug

Instructs the assembler to generate DWARF debug tables.

--debug is a synonym for -g. The default is DWARF 3.

————— **Note** —————

Local symbols are not preserved with --debug. You must specify --keep if you want to preserve the local symbols to aid debugging.

—————

Related references

[10.25 --dwarf2](#) on page 10-250.

[10.26 --dwarf3](#) on page 10-251.

[10.38 --keep](#) on page 10-264.

[10.35 -g](#) on page 10-261.

10.17 --depend=dependfile

Writes makefile dependency lines to a file.

Source file dependency lists are suitable for use with make utilities.

Related references

[10.47 --md](#) on page 10-273.

[10.18 --depend_format=string](#) on page 10-243.

10.18 --depend_format=string

Specifies the format of output dependency files, for compatibility with some UNIX make programs.

Syntax

--depend_format=*string*

Where *string* is one of:

unix

generates dependency file entries using UNIX-style path separators.

unix_escaped

is the same as unix, but escapes spaces with \.

unix_quoted

is the same as unix, but surrounds path names with double quotes.

Related references

[10.17 --depend=dependfile](#) on page 10-242.

10.19 --diag_error=tag[,tag,...]

Sets diagnostic messages that have a specific tag to Error severity.

Syntax

--diag_error=tag[, tag,...]

Where *tag* can be:

- A diagnostic message number to set to error severity. This is the four-digit number, *nnnn*, with the tool letter prefix, but without the letter suffix indicating the severity.
- *warning*, to treat all warnings as errors.

Usage

Diagnostic messages output by the assembler can be identified by a tag in the form of *{prefix}number*, where the *prefix* is A.

You can specify more than one tag with this option by separating each tag using a comma. You can specify the optional assembler prefix A before the tag number. If any prefix other than A is included, the message number is ignored.

The following table shows the meaning of the term severity used in the option descriptions:

Table 10-3 Severity of diagnostic messages

Severity	Description
Error	Errors indicate violations in the syntactic or semantic rules of assembly language. Assembly continues, but object code is not generated.
Warning	Warnings indicate unusual conditions in your code that might indicate a problem. Assembly continues, and object code is generated unless any problems with an Error severity are detected.
Remark	Remarks indicate common, but not recommended, use of assembly language. These diagnostics are not issued by default. Assembly continues, and object code is generated unless any problems with an Error severity are detected.

Related references

[10.8 --brief_diagnostics, --no_brief_diagnostics](#) on page 10-231.

[10.20 --diag_remark=tag\[,tag,...\]](#) on page 10-245.

[10.22 --diag_suppress=tag\[,tag,...\]](#) on page 10-247.

[10.23 --diag_warning=tag\[,tag,...\]](#) on page 10-248.

10.20 --diag_remark=tag[,tag,...]

Sets diagnostic messages that have a specific tag to Remark severity.

Syntax

```
--diag_remark=tag[,tag,...]
```

Where *tag* is a comma-separated list of diagnostic message numbers. This is the four-digit number, *nnnn*, with the tool letter prefix, but without the letter suffix indicating the severity.

Usage

Diagnostic messages output by the assembler can be identified by a tag in the form of *{prefix}number*, where the *prefix* is A.

You can specify more than one tag with this option by separating each tag using a comma. You can specify the optional assembler prefix A before the tag number. If any prefix other than A is included, the message number is ignored.

Related references

[10.8 --brief_diagnostics, --no_brief_diagnostics](#) on page 10-231.

[10.19 --diag_error=tag\[,tag,...\]](#) on page 10-244.

[10.22 --diag_suppress=tag\[,tag,...\]](#) on page 10-247.

[10.23 --diag_warning=tag\[,tag,...\]](#) on page 10-248.

10.21 --diag_style={arm|ide|gnu}

Specifies the display style for diagnostic messages.

Syntax

--diag_style=*string*

Where *string* is one of:

arm

Display messages using the ARM compiler style.

ide

Include the line number and character count for any line that is in error. These values are displayed in parentheses.

gnu

Display messages in the format used by gcc.

Usage

--diag_style=gnu matches the format reported by the GNU Compiler, gcc.

--diag_style=ide matches the format reported by Microsoft Visual Studio.

Choosing the option --diag_style=ide implicitly selects the option --brief_diagnostics. Explicitly selecting --no_brief_diagnostics on the command line overrides the selection of --brief_diagnostics implied by --diag_style=ide.

Selecting either the option --diag_style=arm or the option --diag_style=gnu does not imply any selection of --brief_diagnostics.

Default

The default is --diag_style=arm.

Related references

[10.8 --brief_diagnostics, --no_brief_diagnostics](#) on page 10-231.

[10.19 --diag_error=tag\[,tag,...\]](#) on page 10-244.

[10.20 --diag_remark=tag\[,tag,...\]](#) on page 10-245.

[10.22 --diag_suppress=tag\[,tag,...\]](#) on page 10-247.

[10.23 --diag_warning=tag\[,tag,...\]](#) on page 10-248.

10.22 --diag_suppress=tag[,tag,...]

Suppresses diagnostic messages that have a specific tag.

Syntax

```
--diag_suppress=tag[,tag,...]
```

Where *tag* can be:

- A diagnostic message number to be suppressed. This is the four-digit number, *nnnn*, with the tool letter prefix, but without the letter suffix indicating the severity.
- *error*, to suppress all errors that can be downgraded.
- *warning*, to suppress all warnings.

Diagnostic messages output by `armasm` can be identified by a tag in the form of `{prefix}number`, where the *prefix* is *A*.

You can specify more than one tag with this option by separating each tag using a comma.

Example

For example, to suppress the warning messages that have numbers 1293 and 187, use the following command:

```
armasm --diag_suppress=1293,187
```

You can specify the optional assembler prefix *A* before the tag number. For example:

```
armasm --diag_suppress=A1293,A187
```

If any prefix other than *A* is included, the message number is ignored. Diagnostic message tags can be cut and pasted directly into a command line.

10.23 --diag_warning=tag[,tag,...]

Sets diagnostic messages that have a specific tag to Warning severity.

Syntax

--diag_warning=tag[,tag,...]

Where *tag* can be:

- A diagnostic message number to set to warning severity. This is the four-digit number, *nnnn*, with the tool letter prefix, but without the letter suffix indicating the severity.
- *error*, to set all errors that can be downgraded to warnings.

Diagnostic messages output by the assembler can be identified by a tag in the form of *{prefix}number*, where the *prefix* is A.

You can specify more than one tag with this option by separating each tag using a comma.

You can specify the optional assembler prefix A before the tag number. If any prefix other than A is included, the message number is ignored.

Related references

[10.8 --brief_diagnostics, --no_brief_diagnostics](#) on page 10-231.

[10.19 --diag_error=tag\[,tag,...\]](#) on page 10-244.

[10.20 --diag_remark=tag\[,tag,...\]](#) on page 10-245.

[10.22 --diag_suppress=tag\[,tag,...\]](#) on page 10-247.

10.24 `--dllexport_all`

Controls symbol visibility when building DLLs.

This option gives all exported global symbols `STV_PROTECTED` visibility in ELF rather than `STV_HIDDEN`, unless overridden by source directives.

Related references

[15.27 `EXPORT` or `GLOBAL` on page 15-790.](#)

10.25 --dwarf2

Uses DWARF 2 debug table format.

This option can be used with --debug, to instruct armasm to generate DWARF 2 debug tables.

Related references

[10.16 --debug](#) on page 10-241.

[10.26 --dwarf3](#) on page 10-251.

10.26 --dwarf3

Uses DWARF 3 debug table format.

This option can be used with `--debug`, to instruct the assembler to generate DWARF 3 debug tables. This is the default if `--debug` is specified.

Related references

[10.16 --debug](#) on page 10-241.

[10.25 --dwarf2](#) on page 10-250.

10.27 --errors=errorfile

Redirects the output of diagnostic messages from stderr to the specified errors file.

10.28 --execstack, --no_execstack

Generates a `.note.GNU-stack` section marking the stack as either executable or non-executable.

You can also use the `AREA` directive to generate either an executable or non-executable `.note.GNU-stack` section. The following code generates an executable `.note.GNU-stack` section. Omitting the `CODE` attribute generates a non-executable `.note.GNU-stack` section.

```
AREA |.note.GNU-stack|,ALIGN=0,READONLY,NOALLOC,CODE
```

In the absence of `--execstack` and `--no_execstack`, the `.note.GNU-stack` section is not generated unless it is specified by the `AREA` directive.

If both the command-line option and source directive are used and are different, then the stack is marked as executable.

Table 10-4 Specifying a command-line option and an `AREA` directive for GNU-stack sections

	<code>--execstack</code> command-line option	<code>--no_execstack</code> command-line option
<code>execstack</code> <code>AREA</code> directive	<code>execstack</code>	<code>execstack</code>
<code>no_execstack</code> <code>AREA</code> directive	<code>execstack</code>	<code>no_execstack</code>

Related references

[15.6 `AREA` on page 15-767.](#)

10.29 --execute_only

Adds the EXECONLY AREA attribute to all code sections.

Usage

The EXECONLY AREA attribute causes the linker to treat the section as execute-only.

It is the user's responsibility to ensure that the code in the section is safe to run in execute-only memory. For example:

- The code must not contain literal pools.
- The code must not attempt to load data from the same, or another, execute-only section.

Restrictions

This option is only supported for:

- Processors that support the ARMv7-M architecture, such as Cortex-M3, Cortex-M4, and Cortex-M7.
- Processors that support the ARMv6-M architecture.

————— **Note** —————

ARM has only performed limited testing of execute-only code on ARMv6-M targets.

Related references

[15.6 AREA on page 15-767.](#)

Related information

[Execute-only memory.](#)

[Building applications for execute-only memory.](#)

10.30 --exceptions, --no_exceptions

Enables or disables exception handling.

These options instruct `armasm` to switch on or off exception table generation for all functions defined by `FUNCTION` (or `PROC`) and `ENDFUNC` (or `ENDP`) directives.

`--no_exceptions` causes no tables to be generated. It is the default.

Related references

[10.31 --exceptions_unwind, --no_exceptions_unwind](#) on page 10-256.

[15.39 FRAME UNWIND ON](#) on page 15-803.

[15.40 FRAME UNWIND OFF](#) on page 15-804.

[15.41 FUNCTION or PROC](#) on page 15-805.

[15.24 ENDFUNC or ENDP](#) on page 15-787.

10.31 `--exceptions_unwind`, `--no_exceptions_unwind`

Enables or disables function unwinding for exception-aware code. This option is only effective if `--exceptions` is enabled.

The default is `--exceptions_unwind`.

For finer control, use the `FRAME UNWIND ON` and `FRAME UNWIND OFF` directives.

Related references

[10.30 `--exceptions`, `--no_exceptions`](#) on page 10-255.

[15.39 `FRAME UNWIND ON`](#) on page 15-803.

[15.40 `FRAME UNWIND OFF`](#) on page 15-804.

[15.41 `FUNCTION` or `PROC`](#) on page 15-805.

[15.24 `ENDFUNC` or `ENDP`](#) on page 15-787.

10.32 --fpmode=model

Specifies floating-point standard conformance and sets library attributes and floating-point optimizations.

Syntax

```
--fpmode=model
```

Where *model* is one of:

none

Source code is not permitted to use any floating-point type or floating-point instruction. This option overrides any explicit `--fpu=name` option.

ieee_full

All facilities, operations, and representations guaranteed by the IEEE standard are available in single and double-precision. Modes of operation can be selected dynamically at runtime.

ieee_fixed

IEEE standard with round-to-nearest and no inexact exceptions.

ieee_no_fenv

IEEE standard with round-to-nearest and no exceptions. This mode is compatible with the Java floating-point arithmetic model.

std

IEEE finite values with denormals flushed to zero, round-to-nearest and no exceptions. It is C and C++ compatible. This is the default option.

Finite values are as predicted by the IEEE standard. It is not guaranteed that NaNs and infinities are produced in all circumstances defined by the IEEE model, or that when they are produced, they have the same sign. Also, it is not guaranteed that the sign of zero is that predicted by the IEEE model.

fast

Some value altering optimizations, where accuracy is sacrificed to fast execution. This is not IEEE compatible, and is not standard C.

Note

This does not cause any changes to the code that you write.

Example

```
armasm --fpmode ieee_full inputfile.s
```

Related references

[10.34 --fpu=name on page 10-259.](#)

Related information

[IEEE Standards Association.](#)

10.33 --fpu=list

Lists the FPU architecture names that are supported by the --fpu=name option.

Example

```
armasm --fpu=list
```

Related references

[10.32 --fpmode=model](#) on page 10-257.

[10.34 --fpu=name](#) on page 10-259.

10.34 --fpu=name

Specifies the target FPU architecture.

Syntax

--fpu=*name*

Where *name* is one of:

None

Selects no floating-point option. No floating-point code is to be used. This produces an error if your code contains floating-point instructions.

VFPv2

Selects a hardware floating-point unit conforming to architecture VFPv2.

VFPv3

Selects a hardware vector floating-point unit conforming to architecture VFPv3. VFPv3 is backwards compatible with VFPv2 except that VFPv3 cannot trap floating-point exceptions.

VFPv3_FP16

Selects a hardware vector floating-point unit conforming to architecture VFPv3 that also provides the half-precision extensions.

VFPv3_D16

Selects a hardware vector floating-point unit conforming to VFPv3-D16 architecture.

VFPv3_D16_FP16

Selects a hardware vector floating-point unit conforming to VFPv3-D16 architecture, that also provides the half-precision extensions.

VFPv4

Selects a hardware floating-point unit conforming to the VFPv4 architecture.

VFPv4_D16

Selects a hardware floating-point unit conforming to the VFPv4-D16 architecture.

FPv4-SP

Selects a hardware floating-point unit conforming to the single precision variant of the FPv4 architecture.

FPv5_D16

Selects a hardware floating-point unit conforming to the FPv5-D16 architecture.

FPv5-SP

Selects a hardware floating-point unit conforming to the single precision variant of the FPv5 architecture.

SoftVFP

Selects software floating-point support where floating-point operations are performed by a floating-point library, `fp11b`. This is the default if you do not specify a --fpu option, or if you select a CPU that does not have an FPU.

SoftVFP+VFPv2

Selects a hardware floating-point unit conforming to VFPv2, with software floating-point linkage. Select this option if you are interworking Thumb code with ARM code on a system that implements a VFP unit.

SoftVFP+VFPv3

Selects a hardware vector floating-point unit conforming to VFPv3, with software floating-point linkage.

SoftVFP+VFPv3_FP16

Selects a hardware vector floating-point unit conforming to VFPv3-fp16, with software floating-point linkage.

SoftVFP+VFPv3_D16

Selects a hardware vector floating-point unit conforming to VFPv3-D16, with software floating-point linkage.

- SoftVFP+VFPv3_D16_FP16**
Selects a hardware vector floating-point unit conforming to VFPv3-D16-fp16, with software floating-point linkage.
- SoftVFP+VFPv4**
Selects a hardware floating-point unit conforming to FPv4, with software floating-point linkage.
- SoftVFP+VFPv4_D16**
Selects a hardware floating-point unit conforming to VFPv4-D16, with software floating-point linkage.
- SoftVFP+FPv4-SP**
Selects a hardware floating-point unit conforming to FPv4-SP, with software floating-point linkage.
- SoftVFP+FPv5_D16**
Selects a hardware floating-point unit conforming to FPv5-D16, with software floating-point linkage.
- SoftVFP+FPv5-SP**
Selects a hardware floating-point unit conforming to FPv5-SP, with software floating-point linkage.

To obtain a full list of FPU architectures use the `--fpu=list` option.

Usage

If you specify this option, it overrides any implicit FPU option that appears on the command line, for example, where you use the `--cpu` option.

Any FPU explicitly selected using the `--fpu` option always overrides any FPU implicitly selected using the `--cpu` option. For example, the option `--cpu=ARM1136JF-S --fpu=SoftVFP` generates code that uses the software floating-point library `fp1ib`, even though the choice of CPU implies the use of architecture VFPv2.

`armasm` sets a build attribute corresponding to name in the object file. The linker determines compatibility between object files, and selection of libraries, accordingly.

To control floating-point linkage without affecting the choice of FPU, you can use `--apcs=/softfp` or `--apcs=/hardfp`.

Restrictions

`armasm` only permits hardware VFP architectures, such as `--fpu=VFPv3` or `--fpu=SoftVFP+VFPv2`, to be specified when MRRC and MCRR instructions are supported in the processor instruction set. MRRC and MCRR instructions are not supported in 4, 4T, 5T and 6-M. Therefore, `armasm` does not allow the use of these CPU architectures with hardware VFP architectures.

Other than this, `armasm` does not check that `--cpu` and `--fpu` combinations are valid. Beyond the scope of the assembler, additional architectural constraints apply. For example, VFPv3 is not supported with architectures prior to ARMv7. Therefore, the combination of `--fpu` and `--cpu` options permitted by `armasm` does not necessarily translate to the actual device in use.

NEON support is disabled for `SoftVFP`.

Default

The default target FPU architecture is derived from use of the `--cpu` option.

If the CPU specified with `--cpu` has a VFP coprocessor, the default target FPU architecture is the VFP architecture for that CPU. For example, the option `--cpu ARM1136JF-S` implies the option `--fpu VFPv2`. If a VFP coprocessor is present, VFP instructions are generated.

Related references

[10.32 --fpmode=model on page 10-257.](#)

10.35 -g

Enables the generation of debug tables.

This option is a synonym for `--debug`.

Related references

[10.16 `--debug` on page 10-241.](#)

10.36 --help

Displays a summary of the main command-line options.

Default

This is the default if you specify `armasm` without any options or source files.

Related references

[10.67 --version_number](#) on page 10-293.

[10.69 --vsn](#) on page 10-295.

10.37 -idir[,dir, ...]

Adds directories to the source file include path.

Any directories added using this option have to be fully qualified.

Related references

[15.43 GET or INCLUDE](#) on page 15-807.

10.38 --keep

Instructs the assembler to keep named local labels in the symbol table of the object file, for use by the debugger.

Related references

[15.48 KEEP](#) on page 15-814.

10.39 --length=n

Sets the listing page length.

Length zero means an unpagged listing. The default is 66 lines.

Related references

[10.42 --list=file](#) on page 10-268.

10.40 `--li`

A synonym for the `--littleend` command-line option.

Related references

[10.44 `--littleend`](#) on page 10-270.

[10.7 `--bigend`](#) on page 10-230.

10.41 --library_type=lib

Enables the selected library to be used at link time.

Syntax

--library_type=*lib*

Where *lib* is one of:

standardlib

Specifies that the full ARM runtime libraries are selected at link time. This is the default.

microlib

Specifies that the C micro-library (microlib) is selected at link time.

Note

- This option can be used with the compiler, assembler, or linker when use of the libraries require more specialized optimizations.
 - This option can be overridden at link time by providing it to the linker.
-

Related information

Building an application with microlib.

--library_type=lib compiler option.

10.42 --list=file

Instructs the assembler to output a detailed listing of the assembly language produced by the assembler to a file.

If `-` is given as *file*, the listing is sent to `stdout`.

Use the following command-line options to control the behavior of `--list`:

- `--no_terse`.
- `--width`.
- `--length`.
- `--xref`.

Related references

[10.52 --no_terse](#) on page 10-278.

[10.70 --width=n](#) on page 10-296.

[10.39 --length=n](#) on page 10-265.

[10.71 --xref](#) on page 10-297.

[15.55 OPT](#) on page 15-823.

10.43 --list=

Instructs the assembler to send the detailed assembly language listing to *inputfile.lst*.

————— **Note** —————

You can use `--list` without the equals sign and filename to send the output to *inputfile.lst*. However, this syntax is deprecated and the assembler issues a warning. This syntax is to be removed in a later release. Use `--list=` instead.

—————

Related references

[10.42 --list=file](#) on page 10-268.

10.44 --littleend

Generates code suitable for an ARM processor using little-endian memory access.

Related references

[10.7 --bigend](#) on page 10-230.

10.45 -m

Instructs the assembler to write source file dependency lists to `stdout`.

Related references

[10.47 --md](#) on page 10-273.

10.46 --maxcache=n

Sets the maximum source cache size in bytes.

The default is 8MB. `armasm` gives a warning if the size is less than 8MB.

10.47 --md

Creates makefile dependency lists.

This option instructs the assembler to write source file dependency lists to *inputfile.d*.

Related references

[10.45 -m](#) on page 10-271.

10.48 --no_code_gen

Instructs the assembler to exit after pass 1, generating no object file. This option is useful if you only want to check the syntax of the source code or directives.

10.49 --no_esc

Instructs the assembler to ignore C-style escaped special characters, such as \n and \t.

10.50 --no_hide_all

Gives all exported and imported global symbols STV_DEFAULT visibility in ELF rather than STV_HIDDEN, unless overridden using source directives.

You can use the following directives to specify an attribute that overrides the implicit symbol visibility:

- EXPORT.
- EXTERN.
- GLOBAL.
- IMPORT.

Related references

[15.27 EXPORT or GLOBAL](#) on page 15-790.

[15.45 IMPORT and EXTERN](#) on page 15-810.

10.51 --no_regs

Instructs armasm not to predefine register names.

————— **Note** —————

This option is deprecated. Use --regnames=none instead.

—————

Related references

[10.58 --regnames](#) on page 10-284.

10.52 --no_terse

Instructs the assembler to show in the list file the lines of assembly code that it has skipped because of conditional assembly.

If you do not specify this option, the assembler does not output the skipped assembly code to the list file.

This option turns off the terse flag. By default the terse flag is on.

Related references

[10.42 --list=file](#) on page 10-268.

10.53 --no_warn

Turns off warning messages.

Related references

[10.23 --diag_warning=tag\[,tag,...\]](#) on page 10-248.

10.54 -o filename

Specifies the name of the output file.

If this option is not used, the assembler creates an object filename in the form *inputfilename.o*. This option is case-sensitive.

10.55 --pd

A synonym for the `--predefine` command-line option.

Related references

[10.56 `--predefine` "directive" on page 10-282.](#)

10.56 --predefine "directive"

Instructs `armasm` to pre-execute one of the `SETA`, `SETL`, or `SETS` directives.

You must enclose *directive* in quotes, for example:

```
armasm --predefine "VariableName SETA 20" inputfile.s
```

`armasm` also executes a corresponding `GBLL`, `GBLS`, or `GBLA` directive to define the variable before setting its value.

The variable name is case-sensitive. The variables defined using the command line are global to `armasm` source files specified on the command line.

Considerations when using --predefine

Be aware of the following:

- The command-line interface of your system might require you to enter special character combinations, such as `\`, to include strings in *directive*. Alternatively, you can use `--via file` to include a `--predefine` argument. The command-line interface does not alter arguments from `--via` files.
- `--predefine` is not equivalent to the compiler option `-Dname`. `--predefine` defines a global variable whereas `-Dname` defines a macro that the C preprocessor expands.

Although you can use predefined global variables in combination with assembly control directives, for example `IF` and `ELSE` to control conditional assembly, they are not intended to provide the same functionality as the C preprocessor in `armasm`. If you require this functionality, ARM recommends you use the compiler to pre-process your assembly code.

Related concepts

[6.14 Conditional assembly](#) on page 6-131.

Related references

[10.55 --pd](#) on page 10-281.

[15.42 GBLA, GBLL, and GBLS](#) on page 15-806.

[15.44 IF, ELSE, ENDIF, and ELIF](#) on page 15-808.

[15.63 SETA, SETL, and SETS](#) on page 15-833.

10.57 --reduce_paths, --no_reduce_paths

Enables or disables the elimination of redundant path name information in file paths.

Windows systems impose a 260 character limit on file paths. Where relative pathnames exist whose absolute names expand to longer than 260 characters, you can use the `--reduce_paths` option to reduce absolute pathname length by matching up directories with corresponding instances of `..` and eliminating the directory/`..` sequences in pairs.

`--no_reduce_paths` is the default.

Note

ARM recommends that you avoid using long and deeply nested file paths, in preference to minimizing path lengths using the `--reduce_paths` option.

Note

This option is valid for 32-bit Windows systems only.

Related information

[--reduce_paths](#), [--no_reduce_paths](#) compiler option.

10.58 --regnames

Controls the predefinition of register names.

Syntax

--regnames=*option*

Where *option* is one of the following:

none

Instructs `armasm` not to predefine register names.

callstd

Defines additional register names based on the AAPCS variant that you are using, as specified by the `--apcs` option.

all

Defines all AAPCS registers regardless of the value of `--apcs`.

Related references

[10.51 --no_regs](#) on page 10-277.

[10.3 --apcs=qualifier...qualifier](#) on page 10-225.

[2.11 Predeclared core register names](#) on page 2-46.

[2.12 Predeclared extension register names](#) on page 2-47.

[2.13 Predeclared XScale register names](#) on page 2-48.

[2.14 Predeclared coprocessor names](#) on page 2-49.

10.59 --report-if-not-wysiwyg

Instructs `armasm` to report when it outputs an encoding that was not directly requested in the source code.

This can happen when `armasm`:

- Uses a pseudo-instruction that is not available in other assemblers, for example `MOV32`.
- Outputs an encoding that does not directly match the instruction mnemonic, for example if the assembler outputs the `MVN` encoding when assembling the `MOV` instruction.
- Inserts additional instructions where necessary for instruction syntax semantics, for example `armasm` can insert a missing `IT` instruction before a conditional Thumb instruction.

10.60 --show_cmdline

Outputs the command line used by the assembler.

Usage

Shows the command line after processing by the assembler, and can be useful to check:

- The command line a build system is using.
- How the assembler is interpreting the supplied command line, for example, the ordering of command-line options.

The commands are shown normalized, and the contents of any via files are expanded.

The output is sent to the standard error stream (`stderr`).

Related references

[10.68 --via=filename](#) on page 10-294.

10.61 --split_ldm

Instructs the assembler to fault LDM and STM instructions with a large number of registers.

————— **Note** —————

This option is deprecated.

This option faults LDM instructions if the maximum number of registers transferred exceeds:

- Five, for LDMS that do not load the PC.
- Four, for LDMS that load the PC.

This option faults STM instructions if the maximum number of registers transferred exceeds 5.

Avoiding large multiple register transfers can reduce interrupt latency on ARM systems that:

- Do not have a cache or a write buffer (for example, a cacheless ARM7TDMI).
- Use zero wait-state, 32-bit memory.

Also, avoiding large multiple register transfers:

- Always increases code size.
- Has no significant benefit for cached systems or processors with a write buffer.
- Has no benefit for systems without zero wait-state memory, or for systems with slow peripheral devices. Interrupt latency in such systems is determined by the number of cycles required for the slowest memory or peripheral access. This is typically much greater than the latency introduced by multiple register transfers.

Related references

[11.41 LDM on page 11-372.](#)

10.62 --thumb

Targets the Thumb instruction set.

This option instructs the assembler to interpret instructions as Thumb instructions, using the UAL syntax. This is equivalent to a `THUMB` directive at the start of the source file.

Related references

[10.4 --arm](#) on page 10-227.

[15.65 THUMB](#) on page 15-835.

10.63 --thumbx

Targets the ThumbEE instruction set.

This option instructs the assembler to interpret instructions as ThumbEE instructions, using the UAL syntax. This is equivalent to a THUMBX directive at the start of the source file.

Note

- ARM deprecates the use of ThumbEE instructions.
 - For descriptions of ThumbEE instructions, see the *ARM Architecture Reference Manual*.
-

Related references

[15.66 THUMBX](#) on page 15-836.

Related information

[ARM Architecture Reference Manual](#).

10.64 --unaligned_access, --no_unaligned_access

Enables or disables unaligned accesses to data on ARM architecture-based processors.

These options instruct the assembler to set an attribute in the object file to enable or disable the use of unaligned accesses.

10.65 --unsafe

Enables instructions for other architectures to be assembled without error.

It downgrades error messages to corresponding warning messages. It also suppresses warnings about operator precedence.

Related concepts

[7.20 Binary operators](#) on page 7-157.

Related references

[10.19 --diag_error=tag\[,tag,...\]](#) on page 10-244.

[10.23 --diag_warning=tag\[,tag,...\]](#) on page 10-248.

10.66 --untyped_local_labels

Causes the assembler not to set the Thumb bit for the address of a numeric local label referenced in an LDR pseudo instruction.

When this option is not used, if you reference a numeric local label in an LDR pseudo-instruction, and the label is in Thumb code, then the assembler sets the Thumb bit (bit 0) of the address. You can then use the address as the target for a BX or BLX instruction.

If you require the actual address of the numeric local label, without the Thumb bit set, then use this option.

————— **Note** —————

When using this option, if you use the address in a branch (register) instruction, the assembler treats it as an ARM code address, causing the branch to arrive in ARM state, meaning it would interpret this code as ARM instructions.

Example

```
    THUMB
    ...
1
    ...
    LDR r0,=%B1 ; r0 contains the address of numeric local label "1".
                ; Thumb bit is not set if --untyped_local_labels was
                ; used.
    ...
```

Related concepts

[7.10 Numeric local labels on page 7-147.](#)

Related references

[11.46 LDR pseudo-instruction on page 11-386.](#)

[11.16 B on page 11-335.](#)

10.67 --version_number

Displays the version of armasm you are using.

Usage

The assembler displays the version number in the format nnnbbbb, where:

- nnn is the version number.
- bbbb is the build number.

Example

Version 5.06 build 0019 is displayed as 5060019.

10.68 --via=filename

Reads an additional list of input filenames and assembler options from *filename*.

Syntax

--via=*filename*

Where *filename* is the name of a via file containing options to be included on the command line.

Usage

You can enter multiple --via options on the assembler command line. The --via options can also be included within a via file.

Related concepts

[16.1 Overview of via files on page 16-840.](#)

Related references

[16.2 Via file syntax rules on page 16-841.](#)

10.69 --vsn

Displays the version information and the license details.

————— **Note** —————

--vsn is intended to report the version information for manual inspection. The Component line indicates the release of ARM Compiler you are using. If you need to access the version in other tools or scripts, for example in build scripts, use the output from --version_number.

Example

```
> armasm --vsn
Product: ARM Compiler N.nn
Component: ARM Compiler N.nn (toolchain_build_number)
Tool: armasm [build_number]
license_type
Software supplied by: ARM Limited
```

10.70 --width=n

Sets the listing page width.

The default is 79 characters.

Related references

[10.42 --list=file](#) on page 10-268.

10.71 --xref

Instructs the assembler to list cross-referencing information on symbols, including where they were defined and where they were used, both inside and outside macros.

The default is off.

Related references

[10.42 --list=file](#) on page 10-268.

Chapter 11

ARM and Thumb Instructions

Describes the ARM and Thumb instructions supported by the ARM assembler, `armasm`.

Some instruction descriptions have an Architectures section. Instructions that do not have this section are available in all versions of the ARM instruction set, and all versions of the Thumb instruction set.

It contains the following sections:

- [11.1 ARM and Thumb instruction summary](#) on page 11-303.
- [11.2 Instruction width specifiers](#) on page 11-311.
- [11.3 Flexible second operand \(Operand2\)](#) on page 11-312.
- [11.4 Syntax of Operand2 as a constant](#) on page 11-313.
- [11.5 Syntax of Operand2 as a register with optional shift](#) on page 11-314.
- [11.6 Shift operations](#) on page 11-315.
- [11.7 Saturating instructions](#) on page 11-318.
- [11.8 Condition code suffixes](#) on page 11-319.
- [11.9 ADC](#) on page 11-320.
- [11.10 ADD](#) on page 11-322.
- [11.11 ADR \(PC-relative\)](#) on page 11-325.
- [11.12 ADR \(register-relative\)](#) on page 11-327.
- [11.13 ADRL pseudo-instruction](#) on page 11-329.
- [11.14 AND](#) on page 11-331.
- [11.15 ASR](#) on page 11-333.
- [11.16 B](#) on page 11-335.
- [11.17 BFC](#) on page 11-337.
- [11.18 BFI](#) on page 11-338.
- [11.19 BIC](#) on page 11-339.
- [11.20 BKPT](#) on page 11-341.
- [11.21 BL](#) on page 11-342.

- 11.22 *BLX* on page 11-344.
- 11.23 *BX* on page 11-346.
- 11.24 *BXJ* on page 11-348.
- 11.25 *CBZ* and *CBNZ* on page 11-349.
- 11.26 *CDP* and *CDP2* on page 11-350.
- 11.27 *CLREX* on page 11-351.
- 11.28 *CLZ* on page 11-352.
- 11.29 *CMP* and *CMN* on page 11-353.
- 11.30 *CPS* on page 11-355.
- 11.31 *CPY* pseudo-instruction on page 11-357.
- 11.32 *DBG* on page 11-358.
- 11.33 *DMB* on page 11-359.
- 11.34 *DSB* on page 11-361.
- 11.35 *EOR* on page 11-363.
- 11.36 *ERET* on page 11-365.
- 11.37 *HVC* on page 11-366.
- 11.38 *ISB* on page 11-367.
- 11.39 *IT* on page 11-368.
- 11.40 *LDC* and *LDC2* on page 11-370.
- 11.41 *LDM* on page 11-372.
- 11.42 *LDR* (immediate offset) on page 11-374.
- 11.43 *LDR* (PC-relative) on page 11-377.
- 11.44 *LDR* (register offset) on page 11-380.
- 11.45 *LDR* (register-relative) on page 11-383.
- 11.46 *LDR* pseudo-instruction on page 11-386.
- 11.47 *LDR*, unprivileged on page 11-388.
- 11.48 *LDREX* on page 11-390.
- 11.49 *LSL* on page 11-392.
- 11.50 *LSR* on page 11-394.
- 11.51 *MAR* on page 11-396.
- 11.52 *MCR* and *MCR2* on page 11-397.
- 11.53 *MCRR* and *MCRR2* on page 11-398.
- 11.54 *MIA*, *MIAPH*, and *MIAXy* on page 11-399.
- 11.55 *MLA* on page 11-401.
- 11.56 *MLS* on page 11-402.
- 11.57 *MOV* on page 11-403.
- 11.58 *MOV32* pseudo-instruction on page 11-405.
- 11.59 *MOVT* on page 11-406.
- 11.60 *MRA* on page 11-407.
- 11.61 *MRC* and *MRC2* on page 11-408.
- 11.62 *MRRC* and *MRRC2* on page 11-409.
- 11.63 *MRS* (PSR to general-purpose register) on page 11-410.
- 11.64 *MRS* (system coprocessor register to ARM register) on page 11-412.
- 11.65 *MSR* (ARM register to system coprocessor register) on page 11-413.
- 11.66 *MSR* (general-purpose register to PSR) on page 11-414.
- 11.67 *MUL* on page 11-416.
- 11.68 *MVN* on page 11-418.
- 11.69 *NEG* pseudo-instruction on page 11-420.
- 11.70 *NOP* on page 11-421.
- 11.71 *ORN* (Thumb only) on page 11-422.
- 11.72 *ORR* on page 11-423.
- 11.73 *PKHBT* and *PKHTB* on page 11-425.
- 11.74 *PLD*, *PLDW*, and *PLI* on page 11-427.
- 11.75 *POP* on page 11-429.
- 11.76 *PUSH* on page 11-431.
- 11.77 *QADD* on page 11-432.

- *11.78 QADD8* on page 11-433.
- *11.79 QADD16* on page 11-434.
- *11.80 QASX* on page 11-435.
- *11.81 QDADD* on page 11-436.
- *11.82 QDSUB* on page 11-437.
- *11.83 QSAX* on page 11-438.
- *11.84 QSUB* on page 11-439.
- *11.85 QSUB8* on page 11-440.
- *11.86 QSUB16* on page 11-441.
- *11.87 RBIT* on page 11-442.
- *11.88 REV* on page 11-443.
- *11.89 REV16* on page 11-444.
- *11.90 REVSH* on page 11-445.
- *11.91 RFE* on page 11-446.
- *11.92 ROR* on page 11-448.
- *11.93 RRX* on page 11-450.
- *11.94 RSB* on page 11-452.
- *11.95 RSC* on page 11-454.
- *11.96 SADD8* on page 11-456.
- *11.97 SADD16* on page 11-457.
- *11.98 SASX* on page 11-458.
- *11.99 SBC* on page 11-460.
- *11.100 SBFX* on page 11-462.
- *11.101 SDIV* on page 11-463.
- *11.102 SEL* on page 11-464.
- *11.103 SETEND* on page 11-466.
- *11.104 SEV* on page 11-467.
- *11.105 SHADD8* on page 11-468.
- *11.106 SHADD16* on page 11-469.
- *11.107 SHASX* on page 11-470.
- *11.108 SHSAX* on page 11-471.
- *11.109 SHSUB8* on page 11-472.
- *11.110 SHSUB16* on page 11-473.
- *11.111 SMC* on page 11-474.
- *11.112 SMLAxy* on page 11-475.
- *11.113 SMLAD* on page 11-477.
- *11.114 SMLAL* on page 11-478.
- *11.115 SMLALD* on page 11-479.
- *11.116 SMLALxy* on page 11-480.
- *11.117 SMLAWy* on page 11-481.
- *11.118 SMLSD* on page 11-482.
- *11.119 SMLSLD* on page 11-483.
- *11.120 SMMLA* on page 11-484.
- *11.121 SMMLS* on page 11-485.
- *11.122 SMMUL* on page 11-486.
- *11.123 SMUAD* on page 11-487.
- *11.124 SMULxy* on page 11-488.
- *11.125 SMULL* on page 11-489.
- *11.126 SMULWy* on page 11-490.
- *11.127 SMUSD* on page 11-491.
- *11.128 SRS* on page 11-492.
- *11.129 SSAT* on page 11-494.
- *11.130 SSAT16* on page 11-495.
- *11.131 SSAX* on page 11-496.
- *11.132 SSUB8* on page 11-497.
- *11.133 SSUB16* on page 11-498.

- *11.134 STC and STC2* on page 11-499.
- *11.135 STM* on page 11-501.
- *11.136 STR (immediate offset)* on page 11-503.
- *11.137 STR (register offset)* on page 11-506.
- *11.138 STR, unprivileged* on page 11-509.
- *11.139 STREX* on page 11-511.
- *11.140 SUB* on page 11-513.
- *11.141 SUBS pc, lr* on page 11-515.
- *11.142 SVC* on page 11-517.
- *11.143 SWP and SWPB* on page 11-518.
- *11.144 SXTAB* on page 11-519.
- *11.145 SXTAB16* on page 11-520.
- *11.146 SXTAH* on page 11-521.
- *11.147 SXTB* on page 11-522.
- *11.148 SXTB16* on page 11-523.
- *11.149 SXTH* on page 11-524.
- *11.150 SYS* on page 11-526.
- *11.151 TBB and TBH* on page 11-527.
- *11.152 TEQ* on page 11-528.
- *11.153 TST* on page 11-530.
- *11.154 UADD8* on page 11-531.
- *11.155 UADD16* on page 11-532.
- *11.156 UASX* on page 11-533.
- *11.157 UBFX* on page 11-535.
- *11.158 UDIV* on page 11-536.
- *11.159 UHADD8* on page 11-537.
- *11.160 UHADD16* on page 11-538.
- *11.161 UHASX* on page 11-539.
- *11.162 UHSAX* on page 11-540.
- *11.163 UHSUB8* on page 11-541.
- *11.164 UHSUB16* on page 11-542.
- *11.165 UMAAL* on page 11-543.
- *11.166 UMLAL* on page 11-544.
- *11.167 UMULL* on page 11-545.
- *11.168 UND pseudo-instruction* on page 11-546.
- *11.169 UQADD8* on page 11-547.
- *11.170 UQADD16* on page 11-548.
- *11.171 UQASX* on page 11-549.
- *11.172 UQSAX* on page 11-550.
- *11.173 UQSUB8* on page 11-551.
- *11.174 UQSUB16* on page 11-552.
- *11.175 USAD8* on page 11-553.
- *11.176 USADA8* on page 11-554.
- *11.177 USAT* on page 11-555.
- *11.178 USAT16* on page 11-556.
- *11.179 USAX* on page 11-557.
- *11.180 USUB8* on page 11-559.
- *11.181 USUB16* on page 11-560.
- *11.182 UXTAB* on page 11-561.
- *11.183 UXTAB16* on page 11-562.
- *11.184 UXTAH* on page 11-564.
- *11.185 UXTB* on page 11-565.
- *11.186 UXTB16* on page 11-566.
- *11.187 UXTH* on page 11-567.
- *11.188 WFE* on page 11-568.
- *11.189 WFI* on page 11-569.

- [11.190 YIELD](#) on page 11-570.

11.1 ARM and Thumb instruction summary

Different ARM architectures support different sets of ARM and Thumb instructions.

The following table gives a summary of the availability of ARM and Thumb instructions in different versions of the ARM architecture:

Table 11-1 Summary of ARM and Thumb instructions

Mnemonic	Brief description	Arch. on page 11-309
ADC	Add with Carry	All
ADD	Add	All
ADR	Load program or register-relative address (short range)	All
ADRL pseudo-instruction	Load program or register-relative address (medium range)	x6M
AND	Logical AND	All
ASR	Arithmetic Shift Right	All
B	Branch	All
BFC	Bit Field Clear	T2
BFI	Bit Field Insert	T2
BIC	Bit Clear	All
BKPT	Breakpoint	5
BL	Branch with Link	All
BLX	Branch with Link, change instruction set	T
BX	Branch, change instruction set	T
BXJ	Branch, change to Jazelle	J, x7M
CBZ, CBNZ	Compare and Branch if {Non}Zero	T2
CDP	Coprocessor Data Processing operation	x6M
CDP2	Coprocessor Data Processing operation	5, x6M
CLREX	Clear Exclusive	K, x6M
CLZ	Count leading zeros	5, x6M
CMN, CMP	Compare Negative, Compare	All
CPS	Change Processor State	6
CPY pseudo-instruction	Copy	6
DBG	Debug	7
DMB	Data Memory Barrier	7, 6M
DSB	Data Synchronization Barrier	7, 6M
EOR	Exclusive OR	All
ERET	Exception Return	7VE
HVC	Hypervisor Call	7VE
ISB	Instruction Synchronization Barrier	7, 6M

Table 11-1 Summary of ARM and Thumb instructions (continued)

Mnemonic	Brief description	Arch. on page 11-309
IT	If-Then	T2
LDC	Load Coprocessor	x6M
LDC2	Load Coprocessor	5, x6M
LDM	Load Multiple registers	All
LDR	Load Register with word	All
LDR pseudo-instruction	Load Register pseudo-instruction	All
LDRB	Load Register with byte	All
LDRBT	Load Register with byte, user mode	x6M
LRD	Load Registers with two words	5E, x6M
LDREX	Load Register Exclusive	6, x6M
LDREXB, LDREXH	Load Register Exclusive Byte, Halfword	K, x6M
LDREXD	Load Register Exclusive Doubleword	K, x7M
LDRH	Load Register with halfword	All
LDRHT	Load Register with halfword, user mode	T2
LDRSB	Load Register with signed byte	All
LDRSBT	Load Register with signed byte, user mode	T2
LDRSH	Load Register with signed halfword	All
LDRSHT	Load Register with signed halfword, user mode	T2
LDRT	Load Register with word, user mode	x6M
LSL	Logical Shift Left	All
LSR	Logical Shift Right	All
MAR	Move from Registers to 40-bit Accumulator	XScale
MCR	Move from Register to Coprocessor	x6M
MCR2	Move from Register to Coprocessor	5, x6M
MCRR	Move from Registers to Coprocessor	5E, x6M
MCRR2	Move from Registers to Coprocessor	6, x6M
MIA, MIAPH, MIAxy	Multiply with Internal 40-bit Accumulate	XScale
MLA	Multiply Accumulate	x6M
MLS	Multiply and Subtract	T2
MOV	Move	All
MOVT	Move Top	T2
MOV32 pseudo-instruction	Move 32-bit immediate to register	T2
MRA	Move from 40-bit Accumulator to Registers	XScale
MRC	Move from Coprocessor to Register	x6M
MRC2	Move from Coprocessor to Register	5, x6M

Table 11-1 Summary of ARM and Thumb instructions (continued)

Mnemonic	Brief description	Arch. on page 11-309
MRRC	Move from Coprocessor to Registers	5E, x6M
MRRC2	Move from Coprocessor to Registers	6, x6M
MRS	Move from PSR to register	All
MRS	Move from system Coprocessor to Register	7A, 7R
MSR	Move from register to PSR	All
MSR	Move from Register to system Coprocessor	7A, 7R
MUL	Multiply	All
MVN	Move Not	All
NEG pseudo-instruction	Negate	All
NOP	No Operation	All
ORN	Logical OR NOT	T2
ORR	Logical OR	All
PKHBT, PKHTB	Pack Halfwords	6, 7EM
PLD	Preload Data	5E, x6M
PLDW	Preload Data with intent to Write	7MP
PLI	Preload Instruction	7
POP	POP registers from stack	All
PUSH	PUSH registers to stack	All
QADD	Signed saturating Add	5E, 7EM
QADD8	Signed saturating parallel byte-wise addition	6, 7EM
QADD16	Signed saturating parallel halfword-wise addition	6, 7EM
QASX	Signed saturating parallel add and subtract halfwords with exchange	6, 7EM
QDADD	Signed saturating Double and Add	5E, 7EM
QDSUB	Signed saturating Double and Subtract	5E, 7EM
QSAX	Signed saturating parallel subtract and add halfwords with exchange	6, 7EM
QSUB	Signed saturating Subtract	5E, 7EM
QSUB8	Signed saturating parallel byte-wise subtraction	6, 7EM
QSUB16	Signed saturating parallel halfword-wise subtraction	6, 7EM
RBIT	Reverse Bits	T2
REV	Reverse byte order in a word	6
REV16	Reverse byte order in two halfwords	6
REVSH	Reverse byte order in a halfword and sign extend	6
RFE	Return From Exception	T2, x7M
ROR	Rotate Right Register	All
RRX	Rotate Right with Extend	x6M

Table 11-1 Summary of ARM and Thumb instructions (continued)

Mnemonic	Brief description	Arch. on page 11-309
RSB	Reverse Subtract	All
RSC	Reverse Subtract with Carry	x7M
SADD8	Signed parallel byte-wise addition	6, 7EM
SADD16	Signed parallel halfword-wise addition	6, 7EM
SASX	Signed parallel add and subtract halfwords with exchange	6, 7EM
SBC	Subtract with Carry	All
SBFX	Signed Bit Field eXtract	T2
SDIV	Signed divide	7A, 7M, 7R
SEL	Select bytes according to APSR GE flags	6, 7EM
SETEND	Set Endianness for memory accesses	6, x7M
SEV	Set Event	K, 6M
SHADD8	Signed halving parallel byte-wise addition	6, 7EM
SHADD16	Signed halving parallel halfword-wise addition	6, 7EM
SHASX	Signed halving parallel add and subtract halfwords with exchange	6, 7EM
SHSAX	Signed halving parallel subtract and add halfwords with exchange	6, 7EM
SHSUB8	Signed halving parallel byte-wise subtraction	6, 7EM
SHSUB16	Signed halving parallel halfword-wise subtraction	6, 7EM
SMC	Secure Monitor Call	Z
SMLAxy	Signed Multiply with Accumulate ($32 \leq 16 \times 16 + 32$)	5E, 7EM
SMLAD	Dual Signed Multiply Accumulate	6, 7EM
	($32 \leq 32 + 16 \times 16 + 16 \times 16$)	
SMLAL	Signed Multiply Accumulate ($64 \leq 64 + 32 \times 32$)	x6M
SMLALxy	Signed Multiply Accumulate ($64 \leq 64 + 16 \times 16$)	5E, 7EM
SMLALD	Dual Signed Multiply Accumulate Long	6, 7EM
	($64 \leq 64 + 16 \times 16 + 16 \times 16$)	
SMLAWy	Signed Multiply with Accumulate ($32 \leq 32 \times 16 + 32$)	5E, 7EM
SMLSD	Dual Signed Multiply Subtract Accumulate	6, 7EM
	($32 \leq 32 + 16 \times 16 - 16 \times 16$)	
SMLSLD	Dual Signed Multiply Subtract Accumulate Long	6, 7EM
	($64 \leq 64 + 16 \times 16 - 16 \times 16$)	
SMMLA	Signed top word Multiply with Accumulate ($32 \leq \text{TopWord}(32 \times 32 + 32)$)	6, 7EM
SMMLS	Signed top word Multiply with Subtract ($32 \leq \text{TopWord}(32 - 32 \times 32)$)	6, 7EM
SMMUL	Signed top word Multiply ($32 \leq \text{TopWord}(32 \times 32)$)	6, 7EM

Table 11-1 Summary of ARM and Thumb instructions (continued)

Mnemonic	Brief description	Arch. on page 11-309
SMUAD, SMUSD	Dual Signed Multiply, and Add or Subtract products	6, 7EM
SMULxy	Signed Multiply (32 <= 16 x 16)	5E, 7EM
SMULL	Signed Multiply (64 <= 32 x 32)	x6M
SMULWy	Signed Multiply (32 <= 32 x 16)	5E, 7EM
SRS	Store Return State	T2, x7M
SSAT	Signed Saturate	6, x6M
SSAT16	Signed Saturate, parallel halfwords	6, 7EM
SSAX	Signed parallel subtract and add halfwords with exchange	6, 7EM
SSUB8	Signed parallel byte-wise subtraction	6, 7EM
SSUB16	Signed parallel halfword-wise subtraction	6, 7EM
STC	Store Coprocessor	x6M
STC2	Store Coprocessor	5, x6M
STM	Store Multiple registers	All
STR	Store Register with word	All
STRB	Store Register with byte	All
STRBT	Store Register with byte, user mode	x6M
STRD	Store Registers with two words	5E, x6M
STREX	Store Register Exclusive	6, x6M
STREXB, STREXH	Store Register Exclusive Byte, Halfword	K, x6M
STREXD	Store Register Exclusive Doubleword	K, x7M
STRH	Store Register with halfword	All
STRHT	Store Register with halfword, user mode	T2
STRT	Store Register with word, user mode	x6M
SUB	Subtract	All
SUBS pc, lr	Exception return, no stack	T2, x7M
SVC (formerly SWI)	SuperVisor Call	All
SWP, SWPB	Swap registers and memory (ARM only)	All, x7M
SXTAB	Sign extend Byte, with Addition	6, 7EM
SXTAB16	Sign extend two Bytes, with Addition	6, 7EM
SXTAH	Sign extend Halfword, with Addition	6, 7EM
SXTB	Sign extend Byte	6
SXTH	Sign extend Halfword	6
SXTB16	Sign extend two Bytes	6, 7EM
SYS	Execute system coprocessor instruction	7A, 7R
TBB, TBH	Table Branch Byte, Halfword	T2

Table 11-1 Summary of ARM and Thumb instructions (continued)

Mnemonic	Brief description	Arch. on page 11-309
TEQ	Test Equivalence	x6M
TST	Test	All
UADD8	Unsigned parallel byte-wise addition	6, 7EM
UADD16	Unsigned parallel halfword-wise addition	
UASX	Unsigned parallel add and subtract halfwords with exchange	
UBFX	Unsigned Bit Field eXtract	T2
UDIV	Unsigned divide	7A, 7M, 7R
UHADD8	Unsigned halving parallel byte-wise addition	6, 7EM
UHADD16	Unsigned halving parallel halfword-wise addition	6, 7EM
UHASX	Unsigned halving parallel add and subtract halfwords with exchange	6, 7EM
UHSAX	Unsigned halving parallel subtract and add halfwords with exchange	6, 7EM
UHSUB8	Unsigned halving parallel byte-wise subtraction	6, 7EM
UHSUB16	Unsigned halving parallel halfword-wise subtraction	6, 7EM
UMAAL	Unsigned Multiply Accumulate Accumulate Long	6, 7EM
	($64 \leq 32 + 32 + 32 \times 32$)	
UMLAL	Unsigned Multiply Accumulate	x6M
	($64 \leq 32 \times 32 + 64$), ($64 \leq 32 \times 32$)	
UMULL	Unsigned Multiply	x6M
	($64 \leq 32 \times 32 + 64$), ($64 \leq 32 \times 32$)	
UQADD8	Unsigned saturating parallel byte-wise addition	6, 7EM
UQADD16	Unsigned saturating parallel halfword-wise addition	6, 7EM
UQASX	Unsigned saturating parallel add and subtract halfwords with exchange	6, 7EM
UQSAX	Unsigned saturating parallel subtract and add halfwords with exchange	6, 7EM
UQSUB8	Unsigned saturating parallel byte-wise subtraction	6, 7EM
UQSUB16	Unsigned saturating parallel halfword-wise subtraction	6, 7EM
USAD8	Unsigned Sum of Absolute Differences	6, 7EM
USADA8	Accumulate Unsigned Sum of Absolute Differences	6, 7EM
USAT	Unsigned Saturate	6, x6M
USAT16	Unsigned Saturate, parallel halfwords	6, 7EM
USAX	Unsigned parallel subtract and add halfwords with exchange	6, 7EM
USUB8	Unsigned parallel byte-wise subtraction	6, 7EM
USUB16	Unsigned parallel halfword-wise subtraction	6, 7EM

Table 11-1 Summary of ARM and Thumb instructions (continued)

Mnemonic	Brief description	Arch. on page 11-309
UXTAB	Zero extend Byte with Addition	6, 7EM
UXTAB16	Zero extend two bytes with Addition	6, 7EM
UXTAH	Zero extend Halfword with Addition	6, 7EM
UXTB	Zero extend Byte	6
UXTH	Zero extend Halfword	6
UXTB16	Zero extend two bytes	6, 7EM
V*	NEON and VFP instructions	
WFE	Wait For Event	T2, 6M
WFI	Wait For Interrupt	T2, 6M
YIELD	Yield	T2, 6M

Entries in the Architecture column indicate that the instructions are available as follows:

- All** All versions of the ARM architecture.
- 5** The ARMv5T*, ARMv6*, and ARMv7 architectures.
- 5E** The ARMv5TE, ARMv6*, and ARMv7 architectures.
- 6** The ARMv6* and ARMv7 architectures.
- 6M** The ARMv6-M and ARMv7 architectures.
- x6M** Not available in the ARMv6-M architecture.
- 7** The ARMv7 architectures.
- 7A** The ARMv7-A architecture.
- 7M** The ARMv7-M architecture, including ARMv7E-M implementations.
- x7M** Not available in the ARMv6-M or ARMv7-M architecture, or any ARMv7E-M implementation.
- 7EM** ARMv7E-M implementations but not in the ARMv7-M or ARMv6-M architecture.
- 7R** The ARMv7-R architecture.
- 7MP** The ARMv7 architectures that implement the Multiprocessing Extensions.
- 7VE** The ARMv7 architectures that implement the Virtualization Extensions.
- J** The ARMv5TEJ, ARMv6*, and ARMv7 architectures.
- K** The ARMv6K, and ARMv7 architectures.
- T** The ARMv4T, ARMv5T*, ARMv6*, and ARMv7 architectures.

- T2** The ARMv6T2 and above architectures.
- XScale** XScale versions of the ARM architecture.
- Z** If Security Extensions are implemented.

11.2 Instruction width specifiers

The instruction width specifiers `.w` and `.n` control the size of Thumb instruction encodings for ARMv6T2 or later.

In Thumb code (ARMv6T2 or later) the `.w` width specifier forces the assembler to generate a 32-bit encoding, even if a 16-bit encoding is available. The `.w` specifier has no effect when assembling to ARM code.

In Thumb code the `.n` width specifier forces the assembler to generate a 16-bit encoding. In this case, if the instruction cannot be encoded in 16 bits or if `.n` is used in ARM code, the assembler generates an error.

If you use an instruction width specifier, you must place it immediately after the instruction mnemonic and any condition code, for example:

```
BCS.w label ; forces 32-bit instruction even for a short branch  
B.N label ; faults if label out of range for 16-bit instruction
```

11.3 Flexible second operand (Operand2)

Many ARM and Thumb general data processing instructions have a flexible second operand.

This is shown as *Operand2* in the descriptions of the syntax of each instruction.

Operand2 can be either of the following:

- A constant.
- A register with optional shift.

Related concepts

[11.6 Shift operations](#) on page 11-315.

Related references

[11.4 Syntax of Operand2 as a constant](#) on page 11-313.

[11.5 Syntax of Operand2 as a register with optional shift](#) on page 11-314.

11.4 Syntax of Operand2 as a constant

An Operand2 constant in an instruction has a limited range of values.

Syntax

#constant

where *constant* is an expression evaluating to a numeric value.

Usage

In ARM instructions, *constant* can have any value that can be produced by rotating an 8-bit value right by any even number of bits within a 32-bit word.

In Thumb instructions, *constant* can be:

- Any constant that can be produced by shifting an 8-bit value left by any number of bits within a 32-bit word.
- Any constant of the form `0x00XY00XY`.
- Any constant of the form `0xXY00XY00`.
- Any constant of the form `0xXYXYXYXY`.

Note

In these constants, X and Y are hexadecimal digits.

In addition, in a small number of instructions, *constant* can take a wider range of values. These are listed in the individual instruction descriptions.

When an Operand2 constant is used with the instructions MOV_S, MVN_S, AND_S, ORR_S, ORN_S, EOR_S, BIC_S, TEQ or TST, the carry flag is updated to bit[31] of the constant, if the constant is greater than 255 and can be produced by shifting an 8-bit value. These instructions do not affect the carry flag if Operand2 is any other constant.

Instruction substitution

If the value of an Operand2 constant is not available, but its logical inverse or negation is available, then the assembler produces an equivalent instruction and inverts or negates the constant.

For example, an assembler might assemble the instruction `CMP Rd, #0xFFFFFFFF` as the equivalent instruction `CMN Rd, #0x2`.

Be aware of this when comparing disassembly listings with source code.

You can use the `--diag_warning 1645` assembler command line option to check when an instruction substitution occurs.

Related concepts

[11.6 Shift operations](#) on page 11-315.

Related references

[11.3 Flexible second operand \(Operand2\)](#) on page 11-312.

[11.5 Syntax of Operand2 as a register with optional shift](#) on page 11-314.

11.5 Syntax of Operand2 as a register with optional shift

When you use an Operand2 register in an instruction, you can optionally also specify a shift value.

Syntax

Rm {, *shift*}

where:

Rm

is the register holding the data for the second operand.

shift

is an optional constant or register-controlled shift to be applied to *Rm*. It can be one of:

ASR #*n*

arithmetic shift right *n* bits, $1 \leq n \leq 32$.

LSL #*n*

logical shift left *n* bits, $1 \leq n \leq 31$.

LSR #*n*

logical shift right *n* bits, $1 \leq n \leq 32$.

ROR #*n*

rotate right *n* bits, $1 \leq n \leq 31$.

RRX

rotate right one bit, with extend.

type *Rs*

register-controlled shift is available in ARM code only, where:

type

is one of ASR, LSL, LSR, ROR.

Rs

is a register supplying the shift amount, and only the least significant byte is used.

-

if omitted, no shift occurs, equivalent to LSL #0.

Usage

If you omit the shift, or specify LSL #0, the instruction uses the value in *Rm*.

If you specify a shift, the shift is applied to the value in *Rm*, and the resulting 32-bit value is used by the instruction. However, the contents of the register *Rm* remain unchanged. Specifying a register with shift also updates the carry flag when used with certain instructions.

Related concepts

[11.6 Shift operations on page 11-315.](#)

Related references

[11.3 Flexible second operand \(Operand2\) on page 11-312.](#)

[11.4 Syntax of Operand2 as a constant on page 11-313.](#)

11.6 Shift operations

Register shift operations move the bits in a register left or right by a specified number of bits, called the shift length.

Register shift can be performed:

- Directly by the instructions ASR, LSR, LSL, ROR, and RRX, and the result is written to a destination register.
- During the calculation of *Operand2* by the instructions that specify the second operand as a register with shift. The result is used by the instruction.

The permitted shift lengths depend on the shift type and the instruction, see the individual instruction description or the flexible second operand description. If the shift length is 0, no shift occurs. Register shift operations update the carry flag except when the specified shift length is 0.

Arithmetic shift right (ASR)

Arithmetic shift right by n bits moves the left-hand $32-n$ bits of a register to the right by n places, into the right-hand $32-n$ bits of the result. It copies the original bit[31] of the register into the left-hand n bits of the result.

You can use the ASR $\#n$ operation to divide the value in the register Rm by 2^n , with the result being rounded towards negative-infinity.

When the instruction is ASRS or when ASR $\#n$ is used in *Operand2* with the instructions MOV_S, MVNS, AND_S, ORR_S, ORN_S, EOR_S, BIC_S, TEQ or TST, the carry flag is updated to the last bit shifted out, bit[$n-1$], of the register Rm .

————— **Note** —————

- If n is 32 or more, then all the bits in the result are set to the value of bit[31] of Rm .
- If n is 32 or more and the carry flag is updated, it is updated to the value of bit[31] of Rm .

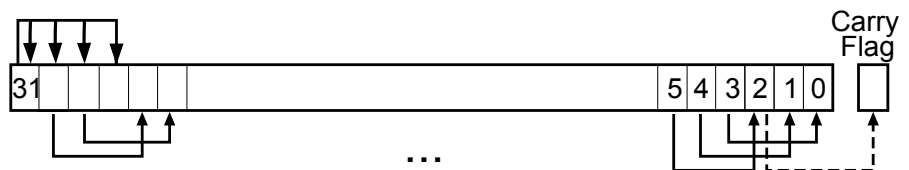

Figure 11-1 ASR #3

Logical shift right (LSR)

Logical shift right by n bits moves the left-hand $32-n$ bits of a register to the right by n places, into the right-hand $32-n$ bits of the result. It sets the left-hand n bits of the result to 0.

You can use the LSR $\#n$ operation to divide the value in the register Rm by 2^n , if the value is regarded as an unsigned integer.

When the instruction is LSRS or when LSR $\#n$ is used in *Operand2* with the instructions MOV_S, MVNS, AND_S, ORR_S, ORN_S, EOR_S, BIC_S, TEQ or TST, the carry flag is updated to the last bit shifted out, bit[$n-1$], of the register Rm .

————— **Note** —————

- If n is 32 or more, then all the bits in the result are cleared to 0.
- If n is 33 or more and the carry flag is updated, it is updated to 0.

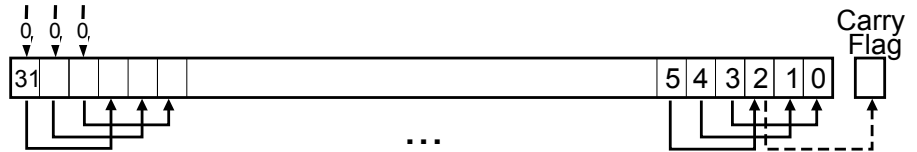

Figure 11-2 LSR #3

Logical shift left (LSL)

Logical shift left by n bits moves the right-hand $32-n$ bits of a register to the left by n places, into the left-hand $32-n$ bits of the result. It sets the right-hand n bits of the result to 0.

You can use the LSL # n operation to multiply the value in the register Rm by 2^n , if the value is regarded as an unsigned integer or a two's complement signed integer. Overflow can occur without warning.

When the instruction is LSLS or when LSL # n , with non-zero n , is used in *Operand2* with the instructions MOV_S, MVNS, AND_S, ORR_S, ORN_S, EOR_S, BIC_S, TEQ or TST, the carry flag is updated to the last bit shifted out, bit[$32-n$], of the register Rm . These instructions do not affect the carry flag when used with LSL #0.

————— **Note** —————

- If n is 32 or more, then all the bits in the result are cleared to 0.
- If n is 33 or more and the carry flag is updated, it is updated to 0.

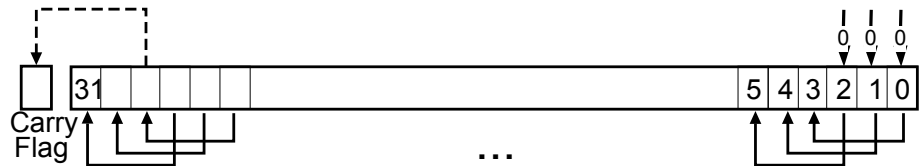

Figure 11-3 LSL #3

Rotate right (ROR)

Rotate right by n bits moves the left-hand $32-n$ bits of a register to the right by n places, into the right-hand $32-n$ bits of the result. It also moves the right-hand n bits of the register into the left-hand n bits of the result.

When the instruction is RORS or when ROR # n is used in *Operand2* with the instructions MOV_S, MVNS, AND_S, ORR_S, ORN_S, EOR_S, BIC_S, TEQ or TST, the carry flag is updated to the last bit rotation, bit[$n-1$], of the register Rm .

————— **Note** —————

- If n is 32, then the value of the result is same as the value in Rm , and if the carry flag is updated, it is updated to bit[31] of Rm .
- ROR with shift length, n , more than 32 is the same as ROR with shift length $n-32$.

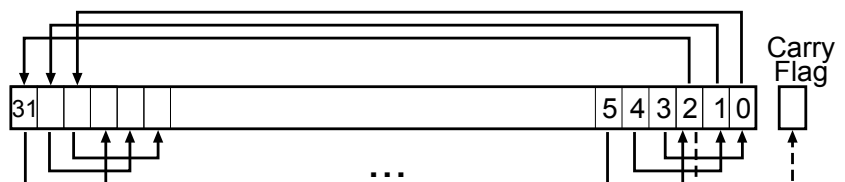

Figure 11-4 ROR #3

Rotate right with extend (RRX)

Rotate right with extend moves the bits of a register to the right by one bit. It copies the carry flag into bit[31] of the result.

When the instruction is RRXS or when RRX is used in *Operand2* with the instructions MOV_S, MVN_S, AND_S, ORR_S, ORN_S, EOR_S, BIC_S, TEQ or TST, the carry flag is updated to bit[0] of the register *Rm*.

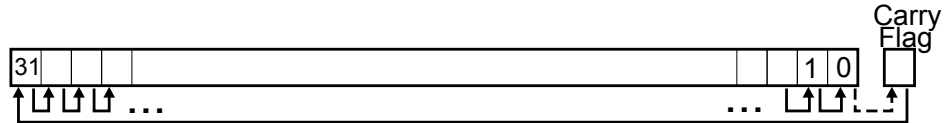

Figure 11-5 RRX

Related references

[11.3 Flexible second operand \(*Operand2*\) on page 11-312.](#)

[11.4 Syntax of *Operand2* as a constant on page 11-313.](#)

[11.5 Syntax of *Operand2* as a register with optional shift on page 11-314.](#)

11.7 Saturating instructions

Some ARM and Thumb instructions perform saturating arithmetic.

The saturating instructions are:

- QADD.
- QDADD.
- QDSUB.
- QSUB.
- SSAT.
- USAT.

Some of the parallel instructions are also saturating.

Saturating arithmetic

Saturation means that, for some value of 2^n that depends on the instruction:

- For a signed saturating operation, if the full result would be less than -2^n , the result returned is -2^n .
- For an unsigned saturating operation, if the full result would be negative, the result returned is zero.
- If the full result would be greater than 2^n-1 , the result returned is 2^n-1 .

When any of these occurs, it is called saturation. Some instructions set the Q flag when saturation occurs.

Note

Saturating instructions do not clear the Q flag when saturation does not occur. To clear the Q flag, use an MSR instruction.

The Q flag can also be set by two other instructions, but these instructions do not saturate.

Related concepts

[8.13 Saturating NEON instructions on page 8-181.](#)

Related references

[11.77 QADD on page 11-432.](#)

[11.84 QSUB on page 11-439.](#)

[11.81 QDADD on page 11-436.](#)

[11.82 QDSUB on page 11-437.](#)

[11.112 SMLAxy on page 11-475.](#)

[11.117 SMLAWy on page 11-481.](#)

[11.124 SMULxy on page 11-488.](#)

[11.126 SMULWy on page 11-490.](#)

[11.129 SSAT on page 11-494.](#)

[11.177 USAT on page 11-555.](#)

[11.66 MSR \(general-purpose register to PSR\) on page 11-414.](#)

11.8 Condition code suffixes

Instructions that can be conditional have an optional two character condition code suffix.

Condition codes are shown in syntax descriptions as {*cond*}. The following table shows the condition codes that you can use:

Table 11-2 Condition code suffixes

Suffix	Meaning
EQ	Equal
NE	Not equal
CS	Carry set (identical to HS)
HS	Unsigned higher or same (identical to CS)
CC	Carry clear (identical to LO)
LO	Unsigned lower (identical to CC)
MI	Minus or negative result
PL	Positive or zero result
VS	Overflow
VC	No overflow
HI	Unsigned higher
LS	Unsigned lower or same
GE	Signed greater than or equal
LT	Signed less than
GT	Signed greater than
LE	Signed less than or equal
AL	Always (this is the default)

————— **Note** —————

The meaning of some of these condition codes depends on whether the instruction that last updated the condition flags is a floating-point or integer instruction.

Related concepts

[8.7 Conditional execution of NEON instructions on page 8-175.](#)

Related references

[5.6 Comparison of condition code meanings in integer and floating-point code on page 5-107.](#)

[11.39 IT on page 11-368.](#)

[13.21 VMRS on page 13-735.](#)

11.9 ADC

Add with Carry.

Syntax

ADC{S}{*cond*} {*Rd*}, *Rn*, *Operand2*

where:

S

is an optional suffix. If S is specified, the condition flags are updated on the result of the operation.

cond

is an optional condition code.

Rd

is the destination register.

Rn

is the register holding the first operand.

Operand2

is a flexible second operand.

Usage

The ADC (Add with Carry) instruction adds the values in *Rn* and *Operand2*, together with the carry flag.

You can use ADC to synthesize multiword arithmetic.

In certain circumstances, the assembler can substitute one instruction for another. Be aware of this when reading disassembly listings.

Use of PC and SP in Thumb instructions

You cannot use PC (R15) for *Rd*, or any operand with the ADC command.

You cannot use SP (R13) for *Rd*, or any operand with the ADC command.

Use of PC and SP in ARM instructions

You cannot use PC for *Rd* or any operand in any data processing instruction that has a register-controlled shift.

Use of PC for any operand, in instructions without register-controlled shift, is deprecated.

If you use PC (R15) as *Rn* or *Operand2*, the value used is the address of the instruction plus 8.

If you use PC as *Rd*:

- Execution branches to the address corresponding to the result.
- If you use the S suffix, see the SUBS *pc*, *1r* instruction.

Use of SP with the ADC ARM instruction is deprecated.

Note

The deprecation of SP and PC in ARM instructions is only in ARMv6T2 and above.

Condition flags

If S is specified, the ADC instruction updates the N, Z, C and V flags according to the result.

16-bit instructions

The following forms of this instruction are available in Thumb code, and are 16-bit instructions:

ADCS *Rd*, *Rd*, *Rm*

Rd and *Rm* must both be Lo registers. This form can only be used outside an IT block.

ADC{*cond*} *Rd*, *Rd*, *Rm*

Rd and *Rm* must both be Lo registers. This form can only be used inside an IT block.

Multiword arithmetic examples

These two instructions add a 64-bit integer contained in R2 and R3 to another 64-bit integer contained in R0 and R1, and place the result in R4 and R5.

```
ADDS    r4, r0, r2    ; adding the least significant words
ADC     r5, r1, r3    ; adding the most significant words
```

Related references

[11.3 Flexible second operand \(Operand2\) on page 11-312.](#)

[11.8 Condition code suffixes on page 11-319.](#)

Related information

[Handling Processor Exceptions.](#)

11.10 ADD

Add without Carry.

Syntax

ADD{S}{cond} {Rd}, Rn, Operand2

ADD{cond} {Rd}, Rn, #imm12 ; Thumb, 32-bit encoding only

where:

S

is an optional suffix. If S is specified, the condition flags are updated on the result of the operation.

cond

is an optional condition code.

Rd

is the destination register.

Rn

is the register holding the first operand.

Operand2

is a flexible second operand.

imm12

is any value in the range 0-4095.

Operation

The ADD instruction adds the values in *Rn* and *Operand2* or *imm12*.

In certain circumstances, the assembler can substitute one instruction for another. Be aware of this when reading disassembly listings.

Use of PC and SP in Thumb instructions

Generally, you cannot use PC (R15) for *Rd*, or any operand.

The exceptions are:

- you can use PC for *Rn* in 32-bit encodings of Thumb ADD instructions, with a constant *Operand2* value in the range 0-4095, and no S suffix. These instructions are useful for generating PC-relative addresses. Bit[1] of the PC value reads as 0 in this case, so that the base address for the calculation is always word-aligned.
- you can use PC in 16-bit encodings of Thumb ADD{cond} Rd, Rd, Rm instructions, where both registers cannot be PC. However, the following 16-bit Thumb instructions are deprecated in ARMv6T2 and above:
 - ADD{cond} PC, SP, PC.
 - ADD{cond} SP, SP, PC.

Generally, you cannot use SP (R13) for *Rd*, or any operand. Except that:

- You can use SP for *Rn* in ADD instructions.
- ADD{cond} SP, SP, SP is permitted but is deprecated in ARMv6T2 and above.
- ADD{S}{cond} SP, SP, Rm{,shift} and SUB{S}{cond} SP, SP, Rm{,shift} are permitted if *shift* is omitted or LSL #1, LSL #2, or LSL #3.

Use of PC and SP in ARM instructions

You cannot use PC for *Rd* or any operand in any data processing instruction that has a register-controlled shift.

In ADD instructions without register-controlled shift, use of PC is deprecated except for the following cases:

- Use of PC for *Rd* in instructions that do not add SP to a register.
- Use of PC for *Rn* and use of PC for *Rm* in instructions that add two registers other than SP.
- Use of PC for *Rn* in the instruction `ADD{cond} Rd, Rn, #Constant`.

If you use PC (R15) as *Rn* or *Rm*, the value used is the address of the instruction plus 8.

If you use PC as *Rd*:

- Execution branches to the address corresponding to the result.
- If you use the S suffix, see the `SUBS pc,1r` instruction.

You can use SP for *Rn* in ADD instructions, however, `ADDS PC, SP, #Constant` is deprecated.

You can use SP in ADD (register) if *Rn* is SP and *shift* is omitted or `LSL #1`, `LSL #2`, or `LSL #3`.

Other uses of SP in these ARM instructions are deprecated.

Note

The deprecation of SP and PC in ARM instructions is only in ARMv6T2 and above.

Condition flags

If S is specified, these instructions update the N, Z, C and V flags according to the result.

16-bit instructions

The following forms of these instructions are available in Thumb code, and are 16-bit instructions:

`ADDS Rd, Rn, #imm`

imm range 0-7. *Rd* and *Rn* must both be Lo registers. This form can only be used outside an IT block.

`ADD{cond} Rd, Rn, #imm`

imm range 0-7. *Rd* and *Rn* must both be Lo registers. This form can only be used inside an IT block.

`ADDS Rd, Rn, Rm`

Rd, *Rn* and *Rm* must all be Lo registers. This form can only be used outside an IT block.

`ADD{cond} Rd, Rn, Rm`

Rd, *Rn* and *Rm* must all be Lo registers. This form can only be used inside an IT block.

`ADD Rd, Rd, Rm`

ARMv6 and earlier: either *Rd* or *Rm*, or both, must be a Hi register. ARMv6T2 and above: this restriction does not apply.

`ADDS Rd, Rd, #imm`

imm range 0-255. *Rd* must be a Lo register. This form can only be used outside an IT block.

`ADD{cond} Rd, Rd, #imm`

imm range 0-255. *Rd* must be a Lo register. This form can only be used inside an IT block.

`ADD SP, SP, #imm`

imm range 0-508, word aligned.

`ADD Rd, SP, #imm`

imm range 0-1020, word aligned. *Rd* must be a Lo register.

`ADD Rd, pc, #imm`

imm range 0-1020, word aligned. *Rd* must be a Lo register. Bits[1:0] of the PC are read as 0 in this instruction.

Example

```
ADD    r2, r1, r3
```

Multiword arithmetic example

These two instructions add a 64-bit integer contained in R2 and R3 to another 64-bit integer contained in R0 and R1, and place the result in R4 and R5.

```
ADDS    r4, r0, r2    ; adding the least significant words
ADC     r5, r1, r3    ; adding the most significant words
```

Related references

[11.3 Flexible second operand \(Operand2\) on page 11-312.](#)

[11.8 Condition code suffixes on page 11-319.](#)

[11.141 SUBS pc, lr on page 11-515.](#)

Related information

[Handling Processor Exceptions.](#)

11.11 ADR (PC-relative)

Generate a PC-relative address in the destination register, for a label in the current area.

Syntax

`ADR{cond}{.w} Rd, Label`

where:

cond

is an optional condition code.

.w

is an optional instruction width specifier.

Rd

is the destination register to load.

Label

is a PC-relative expression.

Label must be within a limited distance of the current instruction.

Usage

ADR produces position-independent code, because the assembler generates an instruction that adds or subtracts a value to the PC.

Use the ADRL pseudo-instruction to assemble a wider range of effective addresses.

Label must evaluate to an address in the same assembler area as the ADR instruction.

If you use ADR to generate a target for a BX or BLX instruction, it is your responsibility to set the Thumb bit (bit 0) of the address if the target contains Thumb instructions.

Offset range and architectures

The assembler calculates the offset from the PC for you. The assembler generates an error if *Label* is out of range.

The following table shows the possible offsets between the label and the current instruction:

Table 11-3 PC-relative offsets

Instruction	Offset range	Architectures
ARM ADR	Any value that can be produced by rotating an 8-bit value right by any even number of bits within a 32-bit word.	All
Thumb ADR, 32-bit encoding	+/- 4095	T2
Thumb ADR, 16-bit encoding ^b	0-1020 ^c	T

Notes about the Architectures column

Entries in the Architectures column indicate that the instructions are available as follows:

All

All versions of the ARM architecture.

T2

The ARMv6T2 and above architectures.

^b Rd must be in the range R0-R7.

^c Must be a multiple of 4.

T

The ARMv4T, ARMv5T*, ARMv6*, and ARMv7 architectures.

ADR in Thumb

You can use the `.w` width specifier to force ADR to generate a 32-bit instruction in Thumb code. ADR with `.w` always generates a 32-bit instruction, even if the address can be generated in a 16-bit instruction.

For forward references, ADR without `.w` always generates a 16-bit instruction in Thumb code, even if that results in failure for an address that could be generated in a 32-bit Thumb ADD instruction.

Restrictions

In Thumb code, `Rd` cannot be PC or SP.

In ARM code, `Rd` can be PC or SP but use of SP is deprecated in ARMv6T2 and above.

Related concepts

[4.9 Load addresses to a register using ADR](#) on page 4-74.

[7.5 Register-relative and PC-relative expressions](#) on page 7-142.

Related references

[11.4 Syntax of Operand2 as a constant](#) on page 11-313.

[11.13 ADRL pseudo-instruction](#) on page 11-329.

[15.6 AREA](#) on page 15-767.

[11.8 Condition code suffixes](#) on page 11-319.

11.12 ADR (register-relative)

Generate a register-relative address in the destination register, for a label defined in a storage map.

Syntax

ADR{*cond*}{*.W*} *Rd*, *Label*

where:

cond

is an optional condition code.

.W

is an optional instruction width specifier.

Rd

is the destination register to load.

Label

is a symbol defined by the FIELD directive. *Label* specifies an offset from the base register which is defined using the MAP directive.

Label must be within a limited distance from the base register.

Usage

ADR generates code to easily access named fields inside a storage map.

Use the ADRL pseudo-instruction to assemble a wider range of effective addresses.

Restrictions

In Thumb code:

- *Rd* cannot be PC.
- *Rd* can be SP only if the base register is SP.

Offset range and architectures

The assembler calculates the offset from the base register for you. The assembler generates an error if *Label* is out of range.

The following table shows the possible offsets between the label and the current instruction:

Table 11-4 Register-relative offsets

Instruction	Offset range	Architectures
ARM ADR	Any value that can be produced by rotating an 8-bit value right by any even number of bits within a 32-bit word.	All
Thumb ADR, 32-bit encoding	+/- 4095	T2
Thumb ADR, 16-bit encoding, base register is SP ^d	0-1020 ^e	T

Notes about the Architectures column

Entries in the Architectures column indicate that the instructions are available as follows:

All

All versions of the ARM architecture.

T2

The ARMv6T2 and above architectures.

^d *Rd* must be in the range R0-R7 or SP. If *Rd* is SP, the offset range is -508 to 508 and must be a multiple of 4
^e Must be a multiple of 4.

T

The ARMv4T, ARMv5T*, ARMv6*, and ARMv7 architectures.

ADR in Thumb

You can use the `.w` width specifier to force ADR to generate a 32-bit instruction in Thumb code. ADR with `.w` always generates a 32-bit instruction, even if the address can be generated in a 16-bit instruction.

For forward references, ADR without `.w`, with base register SP, always generates a 16-bit instruction in Thumb code, even if that results in failure for an address that could be generated in a 32-bit Thumb ADD instruction.

Related concepts

[7.5 Register-relative and PC-relative expressions on page 7-142.](#)

Related references

[11.4 Syntax of Operand2 as a constant on page 11-313.](#)

[11.13 ADRL pseudo-instruction on page 11-329.](#)

[15.52 MAP on page 15-820.](#)

[15.29 FIELD on page 15-793.](#)

[11.8 Condition code suffixes on page 11-319.](#)

11.13 ADRL pseudo-instruction

Load a PC-relative or register-relative address into a register.

Syntax

`ADRL{cond} Rd,Label`

where:

cond
is an optional condition code.

Rd
is the register to load.

Label
is a PC-relative or register-relative expression.

Usage

ADRL always assembles to two 32-bit instructions. Even if the address can be reached in a single instruction, a second, redundant instruction is produced.

If the assembler cannot construct the address in two instructions, it generates an error message and the assembly fails. You can use the LDR pseudo-instruction for loading a wider range of addresses.

ADRL is similar to the ADR instruction, except ADRL can load a wider range of addresses because it generates two data processing instructions.

ADRL produces position-independent code, because the address is PC-relative or register-relative.

If *Label* is PC-relative, it must evaluate to an address in the same assembler area as the ADRL pseudo-instruction.

If you use ADRL to generate a target for a BX or BLX instruction, it is your responsibility to set the Thumb bit (bit 0) of the address if the target contains Thumb instructions.

Architectures and range

The available range depends on the instruction set in use:

ARM

The range of the instruction is any value that can be generated by two ADD or two SUB instructions. That is, any value that can be produced by the addition of two values, each of which is 8 bits rotated right by any even number of bits within a 32-bit word.

Thumb, 32-bit encoding

±1MB bytes to a byte, halfword, or word-aligned address.

Thumb, 16-bit encoding

ADRL is not available.

The given range is relative to a point four bytes (in Thumb code) or two words (in ARM code) after the address of the current instruction.

Note

When assembling Thumb instructions, ADRL is only available in ARMv6T2 and later.

Related concepts

[7.5 Register-relative and PC-relative expressions on page 7-142.](#)

[4.3 Load immediate values on page 4-67.](#)

Related references

[11.4 Syntax of Operand2 as a constant on page 11-313.](#)

11.46 LDR pseudo-instruction on page 11-386.

15.6 AREA on page 15-767.

11.10 ADD on page 11-322.

11.8 Condition code suffixes on page 11-319.

Related information

ARM Architecture Reference Manual.

11.14 AND

Logical AND.

Syntax

AND{S}{*cond*} *Rd*, *Rn*, *Operand2*

where:

S

is an optional suffix. If S is specified, the condition flags are updated on the result of the operation.

cond

is an optional condition code.

Rd

is the destination register.

Rn

is the register holding the first operand.

Operand2

is a flexible second operand.

Operation

The AND instruction performs bitwise AND operations on the values in *Rn* and *Operand2*.

In certain circumstances, the assembler can substitute BIC for AND, or AND for BIC. Be aware of this when reading disassembly listings.

Use of PC in Thumb instructions

You cannot use PC (R15) for *Rd* or any operand with the AND instruction.

Use of PC and SP in ARM instructions

You can use PC and SP with the AND ARM instruction but this is deprecated in ARMv6T2 and above.

If you use PC as *Rn*, the value used is the address of the instruction plus 8.

If you use PC as *Rd*:

- Execution branches to the address corresponding to the result.
- If you use the S suffix, see the SUBS *pc*, *l_r* instruction.

You cannot use PC for any operand in any data processing instruction that has a register-controlled shift.

Condition flags

If S is specified, the AND instruction:

- Updates the N and Z flags according to the result.
- Can update the C flag during the calculation of *Operand2*.
- Does not affect the V flag.

16-bit instructions

The following forms of this instruction are available in Thumb code, and are 16-bit instructions:

ANDS *Rd*, *Rd*, *Rm*

Rd and *Rm* must both be Lo registers. This form can only be used outside an IT block.

AND{*cond*} *Rd*, *Rd*, *Rm*

Rd and *Rm* must both be Lo registers. This form can only be used inside an IT block.

It does not matter if you specify AND{S} *Rd*, *Rm*, *Rd*. The instruction is the same.

Examples

```
AND    r9, r2, #0xFF00  
ANDS   r9, r8, #0x19
```

Related references

[11.3 Flexible second operand \(Operand2\)](#) on page 11-312.

[11.141 SUBS pc, lr](#) on page 11-515.

[11.8 Condition code suffixes](#) on page 11-319.

Related information

[Handling Processor Exceptions.](#)

11.15 ASR

Arithmetic Shift Right. This instruction is a preferred synonym for MOV instructions with shifted register operands.

Syntax

ASR{S}{cond} Rd, Rm, Rs

ASR{S}{cond} Rd, Rm, #sh

where:

S

is an optional suffix. If S is specified, the condition flags are updated on the result of the operation.

Rd

is the destination register.

Rm

is the register holding the first operand. This operand is shifted right.

Rs

is a register holding a shift value to apply to the value in Rm. Only the least significant byte is used.

sh

is a constant shift. The range of values permitted is 1-32.

Operation

ASR provides the signed value of the contents of a register divided by a power of two. It copies the sign bit into vacated bit positions on the left.

Restrictions in Thumb code

Thumb instructions must not use PC or SP.

Use of SP and PC in ARM instructions

You can use SP in the ASR ARM instruction but this is deprecated in ARMv6T2 and above.

You cannot use PC in instructions with the ASR{S}{cond} Rd, Rm, Rs syntax. You can use PC for Rd and Rm in the other syntax, but this is deprecated in ARMv6T2 and above.

If you use PC as Rm, the value used is the address of the instruction plus 8.

If you use PC as Rd:

- Execution branches to the address corresponding to the result.
- If you use the S suffix, the SPSR of the current mode is copied to the CPSR. You can use this to return from exceptions.

————— **Note** —————

The ARM instruction ASRS{cond} pc, Rm, #sh always disassembles to the preferred form MOV{cond} pc, Rm{, shift}.

————— **Caution** —————

Do not use the S suffix when using PC as Rd in User mode or System mode. The assembler cannot warn you about this because it has no information about what the processor mode is likely to be at execution time.

You cannot use PC for Rd or any operand in the ASR instruction if it has a register-controlled shift.

Condition flags

If S is specified, the ASR instruction updates the N and Z flags according to the result.

The C flag is unaffected if the shift value is 0. Otherwise, the C flag is updated to the last bit shifted out.

16-bit instructions

The following forms of these instructions are available in Thumb code, and are 16-bit instructions:

ASRS *Rd*, *Rm*, #*sh*

Rd and *Rm* must both be Lo registers. This form can only be used outside an IT block.

ASR{*cond*} *Rd*, *Rm*, #*sh*

Rd and *Rm* must both be Lo registers. This form can only be used inside an IT block.

ASRS *Rd*, *Rd*, *Rs*

Rd and *Rs* must both be Lo registers. This form can only be used outside an IT block.

ASR{*cond*} *Rd*, *Rd*, *Rs*

Rd and *Rs* must both be Lo registers. This form can only be used inside an IT block.

Architectures

The ASR ARM instruction is available in all architectures.

The ASR 32-bit Thumb instruction is available in ARMv6T2 and above.

The ASR 16-bit Thumb instruction is available in ARMv4T and above.

Example

```
ASR    r7, r8, r9
```

Related references

[11.57 MOV on page 11-403.](#)

[11.8 Condition code suffixes on page 11-319.](#)

11.16 B

Branch.

Syntax

`B{cond}{.w} Label`

where:

cond

is an optional condition code.

.w

is an optional instruction width specifier to force the use of a 32-bit B instruction in Thumb.

Label

is a PC-relative expression.

Operation

The B instruction causes a branch to *Label*.

Instruction availability and branch ranges

The following table shows the B instructions that are available in ARM and Thumb state. Instructions that are not shown in this table are not available. Notes in brackets show the first architecture version where the instruction is available.

Table 11-5 B instruction availability and range

Instruction	ARM		Thumb, 16-bit encoding		Thumb, 32-bit encoding	
	Range	Availability	Range	Availability	Range	Availability
B label	±32MB	(All)	±2KB	(All T)	±16MB ^f	(All T2)
B{cond} label	±32MB	(All)	−252 to +258	(All T)	±1MB ^f	(All T2)

Extending branch ranges

Machine-level B instructions have restricted ranges from the address of the current instruction. However, you can use these instructions even if *Label* is out of range. Often you do not know where the linker places *Label*. When necessary, the linker adds code to enable longer branches. The added code is called a veneer.

B in Thumb

You can use the *.w* width specifier to force B to generate a 32-bit instruction in Thumb code.

B.w always generates a 32-bit instruction, even if the target could be reached using a 16-bit instruction.

For forward references, B without *.w* always generates a 16-bit instruction in Thumb code, even if that results in failure for a target that could be reached using a 32-bit Thumb instruction.

Condition flags

The B instruction does not change the flags.

Architectures

See the preceding table for details of availability of the B instruction in each architecture.

^f Use *.w* to instruct the assembler to use this 32-bit instruction.

Example

```
B      loopA
```

Related concepts

[7.5 Register-relative and PC-relative expressions](#) on page 7-142.

Related references

[11.8 Condition code suffixes](#) on page 11-319.

Related information

Information about image structure and generation.

11.17 BFC

Bit Field Clear.

Syntax

`BFC{cond} Rd, #Lsb, #width`

where:

cond

is an optional condition code.

Rd

is the destination register.

Lsb

is the least significant bit that is to be cleared.

width

is the number of bits to be cleared. *width* must not be 0, and (*width+Lsb*) must be less than or equal to 32.

Operation

Clears adjacent bits in a register. *width* bits in *Rd* are cleared, starting at *Lsb*. Other bits in *Rd* are unchanged.

Register restrictions

You cannot use PC for any register.

You can use SP in the BFC ARM instruction but this is deprecated in ARMv6T2 and above. You cannot use SP in the BFC Thumb instruction.

Condition flags

The BFC instruction does not change the flags.

Architectures

This ARM instruction is available in ARMv6T2 and above.

This 32-bit Thumb instruction is available in ARMv6T2 and above.

There is no 16-bit version of this instruction in Thumb.

Related references

[11.8 Condition code suffixes on page 11-319.](#)

11.18 BFI

Bit Field Insert.

Syntax

`BFI{cond} Rd, Rn, #Lsb, #width`

where:

cond

is an optional condition code.

Rd

is the destination register.

Rn

is the source register.

Lsb

is the least significant bit that is to be copied.

width

is the number of bits to be copied. *width* must not be 0, and (*width*+*Lsb*) must be less than or equal to 32.

Operation

Inserts adjacent bits from one register into another. *width* bits in *Rd*, starting at *Lsb*, are replaced by *width* bits from *Rn*, starting at bit[0]. Other bits in *Rd* are unchanged.

Register restrictions

You cannot use PC for any register.

You can use SP in the BFI ARM instruction but this is deprecated in ARMv6T2 and above. You cannot use SP in the BFI Thumb instruction.

Condition flags

The BFI instruction does not change the flags.

Architectures

This ARM instruction is available in ARMv6T2 and above.

This 32-bit Thumb instruction is available in ARMv6T2 and above.

There is no 16-bit version of this instruction in Thumb.

Related references

[11.8 Condition code suffixes on page 11-319.](#)

11.19 BIC

Bit Clear.

Syntax

`BIC{S}{cond} Rd, Rn, Operand2`

where:

S

is an optional suffix. If S is specified, the condition flags are updated on the result of the operation.

cond

is an optional condition code.

Rd

is the destination register.

Rn

is the register holding the first operand.

Operand2

is a flexible second operand.

Operation

The BIC (Bit Clear) instruction performs an AND operation on the bits in *Rn* with the complements of the corresponding bits in the value of *Operand2*.

In certain circumstances, the assembler can substitute BIC for AND, or AND for BIC. Be aware of this when reading disassembly listings.

Use of PC in Thumb instructions

You cannot use PC (R15) for *Rd* or any operand in a BIC instruction.

Use of PC and SP in ARM instructions

You can use PC and SP with the BIC instruction but they are deprecated in ARMv6T2 and above.

If you use PC as *Rn*, the value used is the address of the instruction plus 8.

If you use PC as *Rd*:

- Execution branches to the address corresponding to the result.
- If you use the S suffix, see the SUBS *pc, lr* instruction.

You cannot use PC for any operand in any data processing instruction that has a register-controlled shift.

Condition flags

If S is specified, the BIC instruction:

- Updates the N and Z flags according to the result.
- Can update the C flag during the calculation of *Operand2*.
- Does not affect the V flag.

16-bit instructions

The following forms of the BIC instruction are available in Thumb code, and are 16-bit instructions:

`BICS Rd, Rd, Rm`

Rd and *Rm* must both be Lo registers. This form can only be used outside an IT block.

`BIC{cond} Rd, Rd, Rm`

Rd and *Rm* must both be Lo registers. This form can only be used inside an IT block.

Example

```
BIC    r0, r1, #0xab
```

Related references

[11.3 Flexible second operand \(Operand2\)](#) on page 11-312.

[11.141 SUBS pc, lr](#) on page 11-515.

[11.8 Condition code suffixes](#) on page 11-319.

Related information

[Handling Processor Exceptions.](#)

11.20 BKPT

Breakpoint.

Syntax

BKPT #*imm*

where:

imm

is an expression evaluating to an integer in the range:

- 0-65535 (a 16-bit value) in an ARM instruction.
- 0-255 (an 8-bit value) in a 16-bit Thumb instruction.

Usage

The BKPT instruction causes the processor to enter Debug state. Debug tools can use this to investigate system state when the instruction at a particular address is reached.

In both ARM state and Thumb state, *imm* is ignored by the ARM hardware. However, a debugger can use it to store additional information about the breakpoint.

BKPT is an unconditional instruction. It must not have a condition code in ARM code. In Thumb code, the BKPT instruction does not require a condition code suffix because BKPT always executes irrespective of its condition code suffix.

Architectures

This ARM instruction is available in ARMv5T and above.

This 16-bit Thumb instruction is available in ARMv5T and above.

There is no 32-bit version of this instruction in Thumb.

11.21 BL

Branch with Link.

Syntax

BL{*cond*}{.w} *Label*

where:

cond

is an optional condition code. *cond* is not available on all forms of this instruction.

.w

is an optional instruction width specifier to force the use of a 32-bit BL instruction in Thumb.

Label

is a PC-relative expression.

Operation

The BL instruction causes a branch to *Label*, and copies the address of the next instruction into LR (R14, the link register).

Instruction availability and branch ranges

The following table shows the BL instructions that are available in ARM and Thumb state. Instructions that are not shown in this table are not available. Notes in brackets show the first architecture version where the instruction is available.

Table 11-6 BL instruction availability and range

Instruction	ARM		Thumb, 16-bit encoding		Thumb, 32-bit encoding	
	Range	Availability	Range	Availability	Range	Availability
BL <i>label</i>	±32MB	(All)	±4MB ^g	(All T)	±16MB	(All T2)
BL{ <i>cond</i> } <i>label</i>	±32MB	(All)	-		-	-

Extending branch ranges

Machine-level BL instructions have restricted ranges from the address of the current instruction. However, you can use these instructions even if *Label* is out of range. Often you do not know where the linker places *Label*. When necessary, the linker adds code to enable longer branches. The added code is called a veneer.

Condition flags

The BL instruction does not change the flags.

Architectures

See the preceding table for details of availability of the BL instruction in each architecture.

Examples

BLE	ng+8
BL	subC
BLLT	rtX

Related concepts

[7.5 Register-relative and PC-relative expressions on page 7-142.](#)

^g BL *label* and BLX *label* are an instruction pair.

Related references

11.8 Condition code suffixes on page 11-319.

Related information

Information about image structure and generation.

11.22 BLX

Branch with Link and exchange instruction set.

Syntax

BLX{*cond*}{.w} *Label*

BLX{*cond*} *Rm*

where:

cond

is an optional condition code. *cond* is not available on all forms of this instruction.

.w

is an optional instruction width specifier to force the use of a 32-bit BLX instruction in Thumb.

Label

is a PC-relative expression.

Rm

is a register containing an address to branch to.

Operation

The BLX instruction causes a branch to *Label*, or to the address contained in *Rm*. In addition:

- The BLX instruction copies the address of the next instruction into LR (R14, the link register).
- The BLX instruction can change the instruction set.

BLX *Label* always changes the instruction set. It changes a processor in ARM state to Thumb state, or a processor in Thumb state to ARM state.

BLX *Rm* derives the target instruction set from bit[0] of *Rm*:

- if bit[0] of *Rm* is 0, the processor changes to, or remains in, ARM state
- if bit[0] of *Rm* is 1, the processor changes to, or remains in, Thumb state.

Instruction availability and branch ranges

The following table shows the BLX instructions that are available in ARM and Thumb state. Instructions that are not shown in this table are not available. Notes in brackets show the first architecture version where the instruction is available.

Table 11-7 BLX instruction availability and range

Instruction	ARM		Thumb, 16-bit encoding		Thumb, 32-bit encoding	
BLX <i>label</i>	±32MB	(5)	±4MB ^h	(5T)	±16MB	(All T2 except ARMv7-M)
BLX <i>Rm</i>	Available	(5)	Available	(5T)	Use 16-bit	(All T2)
BLX{ <i>cond</i> } <i>Rm</i>	Available	(5)	-		-	-

Register restrictions

You can use PC for *Rm* in the ARM BLX instruction, but this is deprecated in ARMv6T2 and above. You cannot use PC in other ARM instructions.

You can use PC for *Rm* in the Thumb BLX instruction. You cannot use PC in other Thumb instructions.

You can use SP for *Rm* in this ARM instruction but this is deprecated in ARMv6T2 and above.

You can use SP for *Rm* in the Thumb BLX instruction, but this is deprecated. You cannot use SP in the other Thumb instructions.

^h BLX *label* and BL *label* are an instruction pair.

Condition flags

This instruction does not change the flags.

Architectures

See the preceding table for details of availability of the BLX instruction in each architecture.

Related concepts

7.5 Register-relative and PC-relative expressions on page 7-142.

Related references

11.8 Condition code suffixes on page 11-319.

Related information

Information about image structure and generation.

11.23 BX

Branch and exchange instruction set.

Syntax

`BX{cond} Rm`

where:

cond

is an optional condition code. *cond* is not available on all forms of this instruction.

Rm

is a register containing an address to branch to.

Operation

The BX instruction causes a branch to the address contained in *Rm* and exchanges the instruction set, if required:

- BX *Rm* derives the target instruction set from bit[0] of *Rm*:
 - If bit[0] of *Rm* is 0, the processor changes to, or remains in, ARM state.
 - If bit[0] of *Rm* is 1, the processor changes to, or remains in, Thumb state.

Instruction availability and branch ranges

The following table shows the instructions that are available in ARM and Thumb state. Instructions that are not shown in this table are not available. Notes in brackets show the first architecture version where the instruction is available.

Table 11-8 BX instruction availability and range

Instruction	ARM		Thumb, 16-bit encoding		Thumb, 32-bit encoding	
	Available	(4T, 5)	Available	(All T)	Use 16-bit	(All T2)
BX <i>Rm</i> ⁱ	Available	(4T, 5)	Available	(All T)	Use 16-bit	(All T2)
BX{cond} <i>Rm</i> ⁱ	Available	(4T, 5)	-		-	-

Register restrictions

You can use PC for *Rm* in the ARM BX instruction, but this is deprecated in ARMv6T2 and above. You cannot use PC in other ARM instructions.

You can use PC for *Rm* in the Thumb BX instruction. You cannot use PC in other Thumb instructions.

You can use SP for *Rm* in the ARM BX instruction but this is deprecated in ARMv6T2 and above.

You can use SP for *Rm* in the Thumb BX instruction, but this is deprecated.

Condition flags

The BX instruction does not change the flags.

Architectures

See the preceding table for details of availability of the BX instruction in each architecture.

Related concepts

[7.5 Register-relative and PC-relative expressions on page 7-142.](#)

ⁱ The assembler accepts BX{cond} *Rm* for code assembled for ARMv4 and converts it to MOV{cond} PC, *Rm* at link time, unless objects targeted for ARMv4T are present.

Related references

11.8 Condition code suffixes on page 11-319.

Related information

Information about image structure and generation.

11.24 BXJ

Branch and change to Jazelle state.

Syntax

`BXJ{cond} Rm`

where:

cond

is an optional condition code. *cond* is not available on all forms of this instruction.

Rm

is a register containing an address to branch to.

Operation

The BXJ instruction causes a branch to the address contained in *Rm* and changes the instruction set state to Jazelle.

Instruction availability and branch ranges

The following table shows the BXJ instructions that are available in ARM and Thumb state. Instructions that are not shown in this table are not available. Notes in brackets show the first architecture version where the instruction is available.

Table 11-9 BXJ instruction availability and range

Instruction	ARM		Thumb, 16-bit encoding		Thumb, 32-bit encoding	
	Available	(5J, 6)	-		Available	(All T2 except ARMv7-M)
BXJ Rm	Available	(5J, 6)	-		Available	(All T2 except ARMv7-M)
BXJ{cond} Rm	Available	(5J, 6)	-		-	-

Register restrictions

You can use SP for *Rm* in the BXJ ARM instruction but this is deprecated in ARMv6T2 and above.

You cannot use SP in the BXJ Thumb instruction.

Condition flags

The BXJ instruction does not change the flags.

Architectures

See the preceding table for details of availability of the BXJ instruction in each architecture.

Related concepts

[7.5 Register-relative and PC-relative expressions on page 7-142.](#)

Related references

[11.8 Condition code suffixes on page 11-319.](#)

Related information

[Information about image structure and generation.](#)

11.25 CBZ and CBNZ

Compare and Branch on Zero, Compare and Branch on Non-Zero.

Syntax

CBZ *Rn*, *Label*

CBNZ *Rn*, *Label*

where:

Rn

is the register holding the operand.

Label

is the branch destination.

Usage

You can use the CBZ or CBNZ instructions to avoid changing the condition flags and to reduce the number of instructions.

Except that it does not change the condition flags, CBZ *Rn*, *label* is equivalent to:

CMP	<i>Rn</i> , #0
BEQ	<i>label</i>

Except that it does not change the condition flags, CBNZ *Rn*, *label* is equivalent to:

CMP	<i>Rn</i> , #0
BNE	<i>label</i>

Restrictions

The branch destination must be within 4 to 130 bytes after the instruction and in the same execution state.

These instructions must not be used inside an IT block.

Condition flags

These instructions do not change the flags.

Architectures

These 16-bit Thumb instructions are available in ARMv6T2 and above.

There are no ARM or 32-bit Thumb encodings of these instructions.

11.26 CDP and CDP2

Coprocessor data operations.

Syntax

CDP{*cond*} *coproc*, #*opcode1*, *CRd*, *CRn*, *CRm*{, #*opcode2*}

CDP2{*cond*} *coproc*, #*opcode1*, *CRd*, *CRn*, *CRm*{, #*opcode2*}

where:

cond

is an optional condition code. In ARM code, *cond* is not permitted for CDP2.

coproc

is the name of the coprocessor the instruction is for. The standard name is *pn*, where *n* is an integer in the range 0 to 15.

opcode1

is a 4-bit coprocessor-specific opcode.

opcode2

is an optional 3-bit coprocessor-specific opcode.

CRd, *CRn*, *CRm*

are coprocessor registers.

Usage

The use of these instructions depends on the coprocessor. See the coprocessor documentation for details.

Architectures

The CDP ARM instruction is available in all versions of the ARM architecture.

The CDP2 ARM instruction is available in ARMv5T and above.

These 32-bit Thumb instructions are available in ARMv6T2 and above.

There are no 16-bit versions of these instructions in Thumb.

Related references

[11.8 Condition code suffixes on page 11-319.](#)

11.27 CLREX

Clear Exclusive.

Syntax

CLREX{*cond*}

where:

cond

is an optional condition code.

————— **Note** —————

cond is permitted only in Thumb code, using a preceding IT instruction. This is an unconditional instruction in ARM.

Usage

Use the CLREX instruction to clear the local record of the executing processor that an address has had a request for an exclusive access.

CLREX returns a closely-coupled exclusive access monitor to its open-access state. This removes the requirement for a dummy store to memory.

It is implementation defined whether CLREX also clears the global record of the executing processor that an address has had a request for an exclusive access.

Architectures

This ARM instruction is available in ARMv6K and above.

This 32-bit Thumb instruction is available in ARMv7 and above.

There is no 16-bit CLREX instruction in Thumb.

Related references

[11.8 Condition code suffixes](#) on page 11-319.

Related information

[ARM Architecture Reference Manual](#).

11.28 CLZ

Count Leading Zeros.

Syntax

```
CLZ{cond} Rd, Rm
```

where:

cond
is an optional condition code.

Rd
is the destination register.

Rm
is the operand register.

Operation

The CLZ instruction counts the number of leading zeros in the value in *Rm* and returns the result in *Rd*. The result value is 32 if no bits are set in the source register, and zero if bit 31 is set.

Register restrictions

You cannot use PC for any operand.

You can use SP in these ARM instructions but this is deprecated in ARMv6T2 and above.

You cannot use SP in Thumb instructions.

Condition flags

This instruction does not change the flags.

Architectures

This ARM instruction is available in ARMv5T and above.

This 32-bit Thumb instruction is available in ARMv6T2 and above.

There is no 16-bit version of this instruction in Thumb.

Examples

```
CLZ    r4, r9
CLZNE  r2, r3
```

Use the CLZ Thumb instruction followed by a left shift of *Rm* by the resulting *Rd* value to normalize the value of register *Rm*. Use MOV_S, rather than MOV, to flag the case where *Rm* is zero:

```
CLZ r5, r9
MOVS r9, r9, LSL r5
```

Related references

[11.8 Condition code suffixes](#) on page 11-319.

11.29 CMP and CMN

Compare and Compare Negative.

Syntax

`CMP{cond} Rn, Operand2`

`CMN{cond} Rn, Operand2`

where:

cond

is an optional condition code.

Rn

is the ARM register holding the first operand.

Operand2

is a flexible second operand.

Operation

These instructions compare the value in a register with *Operand2*. They update the condition flags on the result, but do not place the result in any register.

The CMP instruction subtracts the value of *Operand2* from the value in *Rn*. This is the same as a SUBS instruction, except that the result is discarded.

The CMN instruction adds the value of *Operand2* to the value in *Rn*. This is the same as an ADDS instruction, except that the result is discarded.

In certain circumstances, the assembler can substitute CMN for CMP, or CMP for CMN. Be aware of this when reading disassembly listings.

Use of PC in ARM and Thumb instructions

You cannot use PC for any operand in any data processing instruction that has a register-controlled shift.

You can use PC (R15) in these ARM instructions without register controlled shift but this is deprecated in ARMv6T2 and above.

If you use PC as *Rn* in ARM instructions, the value used is the address of the instruction plus 8.

You cannot use PC for any operand in these Thumb instructions.

Use of SP in ARM and Thumb instructions

You can use SP for *Rn* in ARM and Thumb instructions.

You can use SP for *Rm* in ARM instructions but this is deprecated in ARMv6T2 and above.

You can use SP for *Rm* in a 16-bit Thumb CMP *Rn, Rm* instruction but this is deprecated in ARMv6T2 and above. Other uses of SP for *Rm* are not permitted in Thumb.

Condition flags

These instructions update the N, Z, C and V flags according to the result.

16-bit instructions

The following forms of these instructions are available in Thumb code, and are 16-bit instructions:

`CMP Rn, Rm`

Lo register restriction does not apply.

`CMN Rn, Rm`

Rn and *Rm* must both be Lo registers.

CMP *Rn*, #*imm*

Rn must be a Lo register. *imm* range 0-255.

Correct examples

```
CMP    r2, r9
CMN    r0, #6400
CMPGT  sp, r7, LSL #2
```

Incorrect example

```
CMP    r2, pc, ASR r0 ; PC not permitted with register-controlled shift.
```

Related references

[11.3 Flexible second operand \(Operand2\) on page 11-312.](#)

[11.8 Condition code suffixes on page 11-319.](#)

11.30 CPS

Change Processor State.

Syntax

CPSeffect iflags{, *#mode*}

CPS *#mode*

where:

effect

is one of:

IE

Interrupt or abort enable.

ID

Interrupt or abort disable.

iflags

is a sequence of one or more of:

a

Enables or disables imprecise aborts.

i

Enables or disables IRQ interrupts.

f

Enables or disables FIQ interrupts.

mode

specifies the number of the mode to change to.

Usage

Changes one or more of the mode, A, I, and F bits in the CPSR, without changing the other CPSR bits.

CPS is only permitted in privileged software execution, and has no effect in User mode.

CPS cannot be conditional, and is not permitted in an IT block.

Condition flags

This instruction does not change the condition flags.

16-bit instructions

The following forms of these instructions are available in Thumb code, and are 16-bit instructions:

- CPSIE *iflags*.
- CPSID *iflags*.

You cannot specify a mode change in a 16-bit Thumb instruction.

Architectures

This ARM instruction is available in ARMv6 and above.

This 32-bit Thumb instruction are available in ARMv6T2 and above.

This 16-bit Thumb instruction is available in T variants of ARMv6 and above.

Examples

```

CPSIE if      ; Enable IRQ and FIQ interrupts.
CPSID A      ; Disable imprecise aborts.
CPSID ai, #17 ; Disable imprecise aborts and interrupts, and enter FIQ mode.
CPS #16      ; Enter User mode.

```

Related concepts

2.4 Processor modes, and privileged and unprivileged software execution on page 2-38.

11.31 CPY pseudo-instruction

Copy a value from one register to another.

Syntax

`CPY{cond} Rd, Rm`

where:

cond
is an optional condition code.

Rd
is the destination register.

Rm
is the register holding the value to be copied.

Operation

The CPY pseudo-instruction copies a value from one register to another, without changing the condition flags.

`CPY Rd, Rm` assembles to `MOV Rd, Rm`.

Architectures

This pseudo-instruction is available in ARMv6 and above in ARM code and in T variants of ARMv6 and above in Thumb code.

Register restrictions

Using SP or PC for both *Rd* and *Rm* is deprecated.

Condition flags

This instruction does not change the condition flags.

Related references

[11.57 MOV](#) on page 11-403.

11.32 DBG

Debug.

Syntax

DBG{*cond*} {*option*}

where:

cond

is an optional condition code.

option

is an optional limitation on the operation of the hint. The range is 0-15.

Usage

DBG is a hint instruction. It is optional whether it is implemented or not. If it is not implemented, it behaves as a NOP. The assembler produces a diagnostic message if the instruction executes as NOP on the target.

DBG executes as a NOP instruction in ARMv6K and ARMv6T2.

Debug hint provides a hint to a debugger and related tools. See your debugger and related tools documentation to determine the use, if any, of this instruction.

Architectures

This ARM instruction is available in ARMv6K and above.

This 32-bit Thumb instruction is available in ARMv6T2 and above.

There is no 16-bit version of this instruction in Thumb.

Related references

[11.70 NOP on page 11-421.](#)

[11.8 Condition code suffixes on page 11-319.](#)

11.33 DMB

Data Memory Barrier.

Syntax

DMB{*cond*} {*option*}

where:

cond

is an optional condition code.

————— **Note** —————

cond is permitted only in Thumb code. This is an unconditional instruction in ARM code.

option

is an optional limitation on the operation of the hint. Permitted values are:

SY

Full system DMB operation. This is the default and can be omitted.

ST

DMB operation that waits only for stores to complete.

ISH

DMB operation only to the inner shareable domain.

ISHST

DMB operation that waits only for stores to complete, and only to the inner shareable domain.

NSH

DMB operation only out to the point of unification.

NSHST

DMB operation that waits only for stores to complete and only out to the point of unification.

OSH

DMB operation only to the outer shareable domain.

OSHST

DMB operation that waits only for stores to complete, and only to the outer shareable domain.

Operation

Data Memory Barrier acts as a memory barrier. It ensures that all explicit memory accesses that appear in program order before the DMB instruction are observed before any explicit memory accesses that appear in program order after the DMB instruction. It does not affect the ordering of any other instructions executing on the processor.

Alias

The following alternative values of *option* are supported, but ARM recommends that you do not use them:

- SH is an alias for ISH.
- SHST is an alias for ISHST.
- UN is an alias for NSH.
- UNST is an alias for NSHST.

Architectures

This ARM and 32-bit Thumb instruction is available in ARMv7.

There is no 16-bit version of this instruction in Thumb.

Related references

[11.8 Condition code suffixes](#) on page 11-319.

11.34 DSB

Data Synchronization Barrier.

Syntax

DSB{*cond*} {*option*}

where:

cond

is an optional condition code.

————— **Note** —————

cond is permitted only in Thumb code. This is an unconditional instruction in ARM.

option

is an optional limitation on the operation of the hint. Permitted values are:

SY

Full system DSB operation. This is the default and can be omitted.

ST

DSB operation that waits only for stores to complete.

ISH

DSB operation only to the inner shareable domain.

ISHST

DSB operation that waits only for stores to complete, and only to the inner shareable domain.

NSH

DSB operation only out to the point of unification.

NSHST

DSB operation that waits only for stores to complete and only out to the point of unification.

OSH

DSB operation only to the outer shareable domain.

OSHST

DSB operation that waits only for stores to complete, and only to the outer shareable domain.

Operation

Data Synchronization Barrier acts as a special kind of memory barrier. No instruction in program order after this instruction executes until this instruction completes. This instruction completes when:

- All explicit memory accesses before this instruction complete.
- All Cache, Branch predictor and TLB maintenance operations before this instruction complete.

Alias

The following alternative values of *option* are supported for DSB, but ARM recommends that you do not use them:

- SH is an alias for ISH.
- SHST is an alias for ISHST.
- UN is an alias for NSH.
- UNST is an alias for NSHST.

Architectures

This ARM and 32-bit Thumb instruction is available in ARMv7.

There is no 16-bit version of this instruction in Thumb.

Related references

[11.8 Condition code suffixes](#) on page 11-319.

11.35 EOR

Logical Exclusive OR.

Syntax

`EOR{S}{cond} Rd, Rn, Operand2`

where:

S

is an optional suffix. If S is specified, the condition flags are updated on the result of the operation.

cond

is an optional condition code.

Rd

is the destination register.

Rn

is the register holding the first operand.

Operand2

is a flexible second operand.

Operation

The EOR instruction performs bitwise Exclusive OR operations on the values in *Rn* and *Operand2*.

Use of PC in Thumb instructions

You cannot use PC (R15) for *Rd* or any operand in an EOR instruction.

Use of PC and SP in ARM instructions

You can use PC and SP with the EOR instruction but they are deprecated in ARMv6T2 and above.

If you use PC as *Rn*, the value used is the address of the instruction plus 8.

If you use PC as *Rd*:

- Execution branches to the address corresponding to the result.
- If you use the S suffix, see the SUBS *pc, 1r* instruction.

You cannot use PC for any operand in any data processing instruction that has a register-controlled shift.

Condition flags

If S is specified, the EOR instruction:

- Updates the N and Z flags according to the result.
- Can update the C flag during the calculation of *Operand2*.
- Does not affect the V flag.

16-bit instructions

The following forms of the EOR instruction are available in Thumb code, and are 16-bit instructions:

`EORS Rd, Rd, Rm`

Rd and *Rm* must both be Lo registers. This form can only be used outside an IT block.

`EOR{cond} Rd, Rd, Rm`

Rd and *Rm* must both be Lo registers. This form can only be used inside an IT block.

It does not matter if you specify `EOR{S} Rd, Rm, Rd`. The instruction is the same.

Correct examples

```
EORS    r0, r0, r3, ROR r6
EORS    r7, r11, #0x18181818
```

Incorrect example

```
EORS    r0,pc,r3,ROR r6    ; PC not permitted with register  
                        ; controlled shift
```

Related references

[11.3 Flexible second operand \(Operand2\) on page 11-312.](#)

[11.141 SUBS pc, lr on page 11-515.](#)

[11.8 Condition code suffixes on page 11-319.](#)

Related information

[Handling Processor Exceptions.](#)

11.36 ERET

Exception Return.

Syntax

ERET{*cond*}

where:

cond

is an optional condition code.

Usage

In a processor that implements the Virtualization Extensions, you can use ERET to perform a return from an exception taken to Hyp mode.

Operation

When executed in Hyp mode, ERET loads the PC from ELR_hyp and loads the CPSR from SPSR_hyp. When executed in any other mode, apart from User or System, it behaves as:

- MOVS PC, LR in the ARM instruction set.
- SUBS PC, LR, #0 in the Thumb instruction set.

Notes

You must not use ERET in User or System mode. The assembler cannot warn you about this because it has no information about what the processor mode is likely to be at execution time.

ERET is the preferred synonym for SUBS PC, LR, #0 in the Thumb instruction set.

Architectures

This ARM instruction is available in ARMv7 architectures that include the Virtualization Extensions.

This 32-bit Thumb instruction is available in ARMv7 architectures that include the Virtualization Extensions.

There is no 16-bit version of this instruction in Thumb.

Related concepts

[2.4 Processor modes, and privileged and unprivileged software execution on page 2-38.](#)

Related references

[11.57 MOV on page 11-403.](#)

[11.141 SUBS pc, lr on page 11-515.](#)

[11.8 Condition code suffixes on page 11-319.](#)

[11.37 HVC on page 11-366.](#)

11.37 HVC

Hypervisor Call.

Syntax

HVC #*imm*

where:

imm

is an expression evaluating to an integer in the range 0-65535.

Operation

In a processor that implements the Virtualization Extensions, the HVC instruction causes a Hypervisor Call exception. This means that the processor enters Hyp mode, the CPSR value is saved to the Hyp mode SPSR, and execution branches to the HVC vector.

HVC must not be used if the processor is in Secure state, or in User mode in Non-secure state.

imm is ignored by the processor. However, it can be retrieved by the exception handler to determine what service is being requested.

HVC cannot be conditional, and is not permitted in an IT block.

Notes

The ERET instruction performs an exception return from Hyp mode.

Architectures

This ARM and 32-bit Thumb instruction is available in ARMv7 architectures that include the Virtualization Extensions.

There is no 16-bit version of this instruction in Thumb

Related concepts

[2.4 Processor modes, and privileged and unprivileged software execution](#) on page 2-38.

Related references

[11.36 ERET](#) on page 11-365.

11.38 ISB

Instruction Synchronization Barrier.

Syntax

ISB{*cond*} {*option*}

where:

cond

is an optional condition code.

————— **Note** —————

cond is permitted only in Thumb code. This is an unconditional instruction in ARM code.

option

is an optional limitation on the operation of the hint. The permitted value is:

SY

Full system ISB operation. This is the default and can be omitted.

Operation

Instruction Synchronization Barrier flushes the pipeline in the processor, so that all instructions following the ISB are fetched from cache or memory, after the instruction has been completed. It ensures that the effects of context altering operations, such as changing the ASID, or completed TLB maintenance operations, or branch predictor maintenance operations, in addition to all changes to the CP15 registers, executed before the ISB instruction are visible to the instructions fetched after the ISB.

In addition, the ISB instruction ensures that any branches that appear in program order after it are always written into the branch prediction logic with the context that is visible after the ISB instruction. This is required to ensure correct execution of the instruction stream.

————— **Note** —————

When the target architecture is ARMv7-M, you cannot use an ISB instruction in an IT block, unless it is the last instruction in the block.

Architectures

This ARM and 32-bit Thumb instruction is available in ARMv7.

There is no 16-bit version of this instruction in Thumb.

Related references

[11.8 Condition code suffixes on page 11-319.](#)

11.39 IT

If-Then.

Syntax

IT{x{y{z}}} {*cond*}

where:

- x* specifies the condition switch for the second instruction in the IT block.
- y* specifies the condition switch for the third instruction in the IT block.
- z* specifies the condition switch for the fourth instruction in the IT block.
- cond* specifies the condition for the first instruction in the IT block.

The condition switch for the second, third and fourth instruction in the IT block can be either:

- T Then. Applies the condition *cond* to the instruction.
- E Else. Applies the inverse condition of *cond* to the instruction.

Usage

The IT instruction makes up to four following instructions (the *IT block*) conditional. The conditions can be all the same, or some of them can be the logical inverse of the others.

The instructions (including branches) in the IT block, except the BKPT instruction, must specify the condition in the {*cond*} part of their syntax.

You are not required to write IT instructions in your code, because the assembler generates them for you automatically according to the conditions specified on the following instructions. However, if you do write IT instructions, the assembler validates the conditions specified in the IT instructions against the conditions specified in the following instructions.

Writing the IT instructions ensures that you consider the placing of conditional instructions, and the choice of conditions, in the design of your code.

When assembling to ARM code, the assembler performs the same checks, but does not generate any IT instructions.

With the exception of CMP, CMN, and TST, the 16-bit instructions that normally affect the condition flags, do not affect them when used inside an IT block.

A BKPT instruction in an IT block is always executed, so it does not require a condition in the {*cond*} part of its syntax. The IT block continues from the next instruction.

————— **Note** —————

You can use an IT block for unconditional instructions by using the AL condition.

Conditional branches inside an IT block have a longer branch range than those outside the IT block.

Restrictions

The following instructions are not permitted in an IT block:

- IT.
- CBZ and CBNZ.

- TBB and TBH.
- CPS, CPSID and CPSIE.
- SETEND.

Other restrictions when using an IT block are:

- A branch or any instruction that modifies the PC is only permitted in an IT block if it is the last instruction in the block.
- You cannot branch to any instruction in an IT block, unless when returning from an exception handler.
- You cannot use any assembler directives in an IT block.

Note

The assembler shows a diagnostic message when any of these instructions are used in an IT block.

Condition flags

This instruction does not change the flags.

Exceptions

Exceptions can occur between an IT instruction and the corresponding IT block, or within an IT block. This exception results in entry to the appropriate exception handler, with suitable return information in LR and SPSR.

Instructions designed for use as exception returns can be used as normal to return from the exception, and execution of the IT block resumes correctly. This is the only way that a PC-modifying instruction can branch to an instruction in an IT block.

Architectures

This 16-bit Thumb instruction is available in ARMv6T2 and above.

In ARM code, IT is a pseudo-instruction that does not generate any code.

There is no 32-bit version of this instruction.

Correct examples

```
ITTE    NE           ; IT can be omitted
ANDNE   r0,r0,r1    ; 16-bit AND, not ANDS
ADDSNE  r2,r2,#1    ; 32-bit ADDS (16-bit ADDS does not set flags in
                    ; IT block)
MOVEQ   r2,r3       ; 16-bit MOV
ITT     AL          ; emit 2 non-flag setting 16-bit instructions
ADDAL   r0,r0,r1    ; 16-bit ADD, not ADDS
SUBAL   r2,r2,#1    ; 16-bit SUB, not SUB
ADD     r0,r0,r1    ; expands into 32-bit ADD, and is not in IT block
ITT     EQ
MOVEQ   r0,r1
BEQ     dloop       ; branch at end of IT block is permitted
ITT     EQ
MOVEQ   r0,r1
BKPT   #1           ; BKPT always executes
ADDEQ   r0,r0,#1
```

Incorrect example

```
IT      NE
ADD     r0,r0,r1    ; syntax error: no condition code used in IT block
```

11.40 LDC and LDC2

Transfer Data from memory to Coprocessor.

Syntax

op{L}{*cond*} *coproc*, *CRd*, [*Rn*]

op{L}{*cond*} *coproc*, *CRd*, [*Rn*, #-*offset*] ; offset addressing

op{L}{*cond*} *coproc*, *CRd*, [*Rn*, #-*offset*]! ; pre-index addressing

op{L}{*cond*} *coproc*, *CRd*, [*Rn*], #-*offset* ; post-index addressing

op{L}{*cond*} *coproc*, *CRd*, *Label*

op{L}{*cond*} *coproc*, *CRd*, [*Rn*], {*option*}

where:

op

is LDC or LDC2.

cond

is an optional condition code.

In ARM code, *cond* is not permitted for LDC2.

L

is an optional suffix specifying a long transfer.

coproc

is the name of the coprocessor the instruction is for. The standard name is *pn*, where *n* is an integer in the range 0 to 15.

CRd

is the coprocessor register to load.

Rn

is the register on which the memory address is based. If PC is specified, the value used is the address of the current instruction plus eight.

-

is an optional minus sign. If - is present, the offset is subtracted from *Rn*. Otherwise, the offset is added to *Rn*.

offset

is an expression evaluating to a multiple of 4, in the range 0 to 1020.

!

is an optional suffix. If ! is present, the address including the offset is written back into *Rn*.

Label

is a word-aligned PC-relative expression.

Label must be within 1020 bytes of the current instruction.

option

is a coprocessor option in the range 0-255, enclosed in braces.

Usage

The use of these instructions depends on the coprocessor. See the coprocessor documentation for details.

Architectures

LDC is available in all versions of the ARM architecture.

LDC2 is available in ARMv5T and above.

These 32-bit Thumb instructions are available in ARMv6T2 and above.

There are no 16-bit versions of these instructions in Thumb.

Register restrictions

You cannot use PC for Rn in the pre-index and post-index instructions. These are the forms that write back to Rn .

Related concepts

[7.5 Register-relative and PC-relative expressions](#) on page 7-142.

[6.16 Address alignment](#) on page 6-134.

Related references

[11.8 Condition code suffixes](#) on page 11-319.

11.41 LDM

Load Multiple registers.

Syntax

```
LDM{addr_mode}{cond} Rn{!}, regList{^}
```

where:

addr_mode

is any one of the following:

IA

Increment address After each transfer. This is the default, and can be omitted.

IB

Increment address Before each transfer (ARM only).

DA

Decrement address After each transfer (ARM only).

DB

Decrement address Before each transfer.

You can also use the stack oriented addressing mode suffixes, for example, when implementing stacks.

cond

is an optional condition code.

Rn

is the *base register*, the ARM register holding the initial address for the transfer. *Rn* must not be PC.

!

is an optional suffix. If ! is present, the final address is written back into *Rn*.

regList

is a list of one or more registers to be loaded, enclosed in braces. It can contain register ranges. It must be comma separated if it contains more than one register or register range. Any combination of registers R0 to R15 (PC) can be transferred in ARM state, but there are some restrictions in Thumb state.

^

is an optional suffix, available in ARM state only. You must not use it in User mode or System mode. It has the following purposes:

- If *regList* contains the PC (R15), in addition to the normal multiple register transfer, the SPSR is copied into the CPSR. This is for returning from exception handlers. Use this only from exception modes.
- Otherwise, data is transferred into or out of the User mode registers instead of the current mode registers.

Restrictions on reglist in 32-bit Thumb instructions

In 32-bit Thumb instructions:

- The SP cannot be in the list.
- The PC and LR cannot both be in the list.
- There must be two or more registers in the list.

If you write an LDM instruction with only one register in *reglist*, the assembler automatically substitutes the equivalent LDR instruction. Be aware of this when comparing disassembly listings with source code.

You can use the `--diag_warning 1645` assembler command line option to check when an instruction substitution occurs.

Restrictions on regist in ARM instructions

ARM load instructions can have SP and PC in the *regList* but these instructions that include SP in the *regList* or both PC and LR in the *regList* are deprecated in ARMv6T2 and above.

16-bit instructions

16-bit versions of a subset of these instructions are available in Thumb code.

The following restrictions apply to the 16-bit instructions:

- All registers in *regList* must be Lo registers.
- *Rn* must be a Lo register.
- *addr_mode* must be omitted (or IA), meaning increment address after each transfer.
- Writeback must be specified for LDM instructions where *Rn* is not in the *regList*.

In addition, the PUSH and POP instructions are subsets of the STM and LDM instructions and can therefore be expressed using the STM and LDM instructions. Some forms of PUSH and POP are also 16-bit instructions.

Loading to the PC

A load to the PC causes a branch to the instruction at the address loaded.

In ARMv4, bits[1:0] of the address loaded must be 0b00.

In ARMv5T and above:

- Bits[1:0] must not be 0b10.
- If bit[0] is 1, execution continues in Thumb state.
- If bit[0] is 0, execution continues in ARM state.

Loading or storing the base register, with writeback

In ARM or 16-bit Thumb instructions, if *Rn* is in *regList*, and writeback is specified with the ! suffix:

- If the instruction is `STM{addr_mode}{cond}` and *Rn* is the lowest-numbered register in *regList*, the initial value of *Rn* is stored. These instructions are deprecated in ARMv6T2 and above.
- Otherwise, the loaded or stored value of *Rn* cannot be relied on, so these instructions are not permitted.

32-bit Thumb instructions are not permitted if *Rn* is in *regList*, and writeback is specified with the ! suffix.

Correct example

```
LDM    r8, {r0, r2, r9}    ; LDMIA is a synonym for LDM
```

Incorrect example

```
LDMDA  r2, {}             ; must be at least one register in list
```

Related concepts

[4.15 Stack implementation using LDM and STM on page 4-82.](#)

[6.16 Address alignment on page 6-134.](#)

Related references

[11.75 POP on page 11-429.](#)

[11.8 Condition code suffixes on page 11-319.](#)

11.42 LDR (immediate offset)

Load with immediate offset, pre-indexed immediate offset, or post-indexed immediate offset.

Syntax

LDR{*type*}{*cond*} *Rt*, [*Rn* {, #*offset*}] ; immediate offset

LDR{*type*}{*cond*} *Rt*, [*Rn*, #*offset*]! ; pre-indexed

LDR{*type*}{*cond*} *Rt*, [*Rn*], #*offset* ; post-indexed

LDRD{*cond*} *Rt*, *Rt2*, [*Rn* {, #*offset*}] ; immediate offset, doubleword

LDRD{*cond*} *Rt*, *Rt2*, [*Rn*, #*offset*]! ; pre-indexed, doubleword

LDRD{*cond*} *Rt*, *Rt2*, [*Rn*], #*offset* ; post-indexed, doubleword

where:

type

can be any one of:

B

unsigned Byte (Zero extend to 32 bits on loads.)

SB

signed Byte (LDR only. Sign extend to 32 bits.)

H

unsigned Halfword (Zero extend to 32 bits on loads.)

SH

signed Halfword (LDR only. Sign extend to 32 bits.)

-

omitted, for Word.

cond

is an optional condition code.

Rt

is the register to load.

Rn

is the register on which the memory address is based.

offset

is an offset. If *offset* is omitted, the address is the contents of *Rn*.

Rt2

is the additional register to load for doubleword operations.

Not all options are available in every instruction set and architecture.

Offset ranges and architectures

The following table shows the ranges of offsets and availability of these instructions:

Table 11-10 Offsets and architectures, LDR, word, halfword, and byte

Instruction	Immediate offset	Pre-indexed	Post-indexed	Arch.
ARM, word or byte ^j	-4095 to 4095	-4095 to 4095	-4095 to 4095	All
ARM, signed byte, halfword, or signed halfword	-255 to 255	-255 to 255	-255 to 255	All
ARM, doubleword	-255 to 255	-255 to 255	-255 to 255	5E

Table 11-10 Offsets and architectures, LDR, word, halfword, and byte (continued)

Instruction	Immediate offset	Pre-indexed	Post-indexed	Arch.
Thumb 32-bit encoding, word, halfword, signed halfword, byte, or signed byte ^j	–255 to 4095	–255 to 255	–255 to 255	T2
Thumb 32-bit encoding, doubleword	–1020 to 1020 ^k	–1020 to 1020 ^k	–1020 to 1020 ^k	T2
Thumb 16-bit encoding, word ^l	0 to 124 ^k	Not available	Not available	T
Thumb 16-bit encoding, unsigned halfword ^l	0 to 62 ^m	Not available	Not available	T
Thumb 16-bit encoding, unsigned byte ^l	0 to 31	Not available	Not available	T
Thumb 16-bit encoding, word, Rn is SP ⁿ	0 to 1020 ^k	Not available	Not available	T

Notes about the Architectures column

Entries in the Architecture column indicate that the instructions are available as follows:

All

All versions of the ARM architecture.

5E

The ARMv5TE, ARMv6*, and ARMv7 architectures.

T2

The ARMv6T2 and above architectures.

T

The ARMv4T, ARMv5T*, ARMv6*, and ARMv7 architectures.

Register restrictions

Rn must be different from Rt in the pre-index and post-index forms.

Doubleword register restrictions

Rn must be different from Rt2 in the pre-index and post-index forms.

For Thumb instructions, you must not specify SP or PC for either Rt or Rt2.

For ARM instructions:

- Rt must be an even-numbered register.
- Rt must not be LR.
- ARM strongly recommends that you do not use R12 for Rt.
- Rt2 must be R(t + 1).

Use of PC

In ARM code you can use PC for Rt in LDR word instructions and PC for Rn in LDR instructions.

Other uses of PC are not permitted in these ARM instructions.

In Thumb code you can use PC for Rt in LDR word instructions and PC for Rn in LDR instructions. Other uses of PC in these Thumb instructions are not permitted.

Use of SP

You can use SP for Rn.

^j For word loads, Rt can be the PC. A load to the PC causes a branch to the address loaded. In ARMv4, bits[1:0] of the address loaded must be 0b00. In ARMv5T and above, bits[1:0] must not be 0b10, and if bit[0] is 1, execution continues in Thumb state, otherwise execution continues in ARM state.

^k Must be divisible by 4.

^l Rt and Rn must be in the range R0-R7.

^m Must be divisible by 2.

ⁿ Rt must be in the range R0-R7.

In ARM code, you can use SP for R t in word instructions. You can use SP for R t in non-word instructions in ARM code but this is deprecated in ARMv6T2 and above.

In Thumb code, you can use SP for R t in word instructions only. All other use of SP for R t in these instructions are not permitted in Thumb code.

Examples

```
LDR    r8,[r10]    ; loads R8 from the address in R10.  
LDRNE  r2,[r5,#960]! ; (conditionally) loads R2 from a word  
                    ; 960 bytes above the address in R5, and  
                    ; increments R5 by 960.
```

Related concepts

[6.16 Address alignment](#) on page 6-134.

Related references

[11.8 Condition code suffixes](#) on page 11-319.

11.43 LDR (PC-relative)

Load register. The address is an offset from the PC.

Syntax

`LDR{type}{cond}{.W} Rt, Label`

`LDRD{cond} Rt, Rt2, Label ; Doubleword`

where:

type

can be any one of:

B

unsigned Byte (Zero extend to 32 bits on loads.)

SB

signed Byte (LDR only. Sign extend to 32 bits.)

H

unsigned Halfword (Zero extend to 32 bits on loads.)

SH

signed Halfword (LDR only. Sign extend to 32 bits.)

-

omitted, for Word.

cond

is an optional condition code.

.W

is an optional instruction width specifier.

Rt

is the register to load or store.

Rt2

is the second register to load or store.

Label

is a PC-relative expression.

Label must be within a limited distance of the current instruction.

Note

Equivalent syntaxes are available for the STR instruction in ARM code but they are deprecated in ARMv6T2 and above.

Offset range and architectures

The assembler calculates the offset from the PC for you. The assembler generates an error if *Label* is out of range.

The following table shows the possible offsets between the label and the current instruction:

Table 11-11 PC-relative offsets

Instruction	Offset range	Architectures
ARM LDR, LDRB, LDRSB, LDRH, LDRSH ^o	+/- 4095	All
ARM LDRD	+/- 255	5E
32-bit Thumb LDR, LDRB, LDRSB, LDRH, LDRSH ^o	+/- 4095	T2
32-bit Thumb LDRD ^p	+/- 1020 ^q	T2
16-bit Thumb LDR ^r	0-1020 ^q	T

Notes about the Architectures column

Entries in the Architectures column indicate that the instructions are available as follows:

All

All versions of the ARM architecture.

5E

The ARMv5TE, ARMv6*, and ARMv7 architectures.

T2

The ARMv6T2 and above architectures.

T

The ARMv4T, ARMv5T*, ARMv6*, and ARMv7 architectures.

LDR (PC-relative) in Thumb

You can use the `.w` width specifier to force LDR to generate a 32-bit instruction in Thumb code. LDR.`w` always generates a 32-bit instruction, even if the target could be reached using a 16-bit LDR.

For forward references, LDR without `.w` always generates a 16-bit instruction in Thumb code, even if that results in failure for a target that could be reached using a 32-bit Thumb LDR instruction.

Doubleword register restrictions

For 32-bit Thumb instructions, you must not specify SP or PC for either `Rt` or `Rt2`.

For ARM instructions:

- `Rt` must be an even-numbered register.
- `Rt` must not be LR.
- ARM strongly recommends that you do not use R12 for `Rt`.
- `Rt2` must be $R(t + 1)$.

Use of SP

In ARM code, you can use SP for `Rt` in LDR word instructions. You can use SP for `Rt` in LDR non-word ARM instructions but this is deprecated in ARMv6T2 and above.

In Thumb code, you can use SP for `Rt` in LDR word instructions only. All other uses of SP in these instructions are not permitted in Thumb code.

Related concepts

[7.5 Register-relative and PC-relative expressions on page 7-142.](#)

[6.16 Address alignment on page 6-134.](#)

^o For word loads, `Rt` can be the PC. A load to the PC causes a branch to the address loaded. In ARMv4, bits[1:0] of the address loaded must be 0b00. In ARMv5T and above, bits[1:0] must not be 0b10, and if bit[0] is 1, execution continues in Thumb state, otherwise execution continues in ARM state.

^p In ARMv7-M, LDRD (PC-relative) instructions must be on a word-aligned address.

^q Must be a multiple of 4.

^r `Rt` must be in the range R0-R7. There are no byte, halfword, or doubleword 16-bit instructions.

Related references

[11.8 Condition code suffixes](#) on page 11-319.

11.44 LDR (register offset)

Load with register offset, pre-indexed register offset, or post-indexed register offset.

Syntax

LDR{*type*}{*cond*} *Rt*, [*Rn*, $\pm Rm$ {, *shift*}] ; register offset
 LDR{*type*}{*cond*} *Rt*, [*Rn*, $\pm Rm$ {, *shift*}]! ; pre-indexed ; ARM only
 LDR{*type*}{*cond*} *Rt*, [*Rn*], $\pm Rm$ {, *shift*} ; post-indexed ; ARM only
 LDRD{*cond*} *Rt*, *Rt2*, [*Rn*, $\pm Rm$] ; register offset, doubleword ; ARM only
 LDRD{*cond*} *Rt*, *Rt2*, [*Rn*, $\pm Rm$]! ; pre-indexed, doubleword ; ARM only
 LDRD{*cond*} *Rt*, *Rt2*, [*Rn*], $\pm Rm$; post-indexed, doubleword ; ARM only

where:

type

can be any one of:

- B** unsigned Byte (Zero extend to 32 bits on loads.)
- SB** signed Byte (LDR only. Sign extend to 32 bits.)
- H** unsigned Halfword (Zero extend to 32 bits on loads.)
- SH** signed Halfword (LDR only. Sign extend to 32 bits.)
- omitted, for Word.

cond

is an optional condition code.

Rt

is the register to load.

Rn

is the register on which the memory address is based.

Rm

is a register containing a value to be used as the offset. $-Rm$ is not permitted in Thumb code.

shift

is an optional shift.

Rt2

is the additional register to load for doubleword operations.

Not all options are available in every instruction set and architecture.

Offset register and shift options

The following table shows the ranges of offsets and availability of these instructions:

Table 11-12 Options and architectures, LDR (register offsets)

Instruction	+/-Rm ^s	shift			Arch.
ARM, word or byte ^t	+/-Rm	LSL #0-31	LSR #1-32		All
		ASR #1-32	ROR #1-31	RRX	
ARM, signed byte, halfword, or signed halfword	+/-Rm	Not available			All
ARM, doubleword	+/-Rm	Not available			5E
Thumb 32-bit encoding, word, halfword, signed halfword, byte, or signed byte ^t	+Rm	LSL #0-3			T2
Thumb 16-bit encoding, all except doubleword ^u	+Rm	Not available			T

Notes about the Architecture column

Entries in the Architecture column indicate that the instructions are available as follows:

All

All versions of the ARM architecture.

5E

The ARMv5TE, ARMv6*, and ARMv7 architectures.

T2

The ARMv6T2 and above architectures.

T

The ARMv4T, ARMv5T*, ARMv6*, and ARMv7 architectures.

Register restrictions

In the pre-index and post-index forms:

- Rn must be different from Rt.
- Rn must be different from Rm in architectures before ARMv6.

Doubleword register restrictions

For ARM instructions:

- Rt must be an even-numbered register.
- Rt must not be LR.
- ARM strongly recommends that you do not use R12 for Rt.
- Rt2 must be R(t + 1).
- Rm must be different from Rt and Rt2 in LDRD instructions.
- Rn must be different from Rt2 in the pre-index and post-index forms.

Use of PC

In ARM instructions you can use PC for Rt in LDR word instructions, and you can use PC for Rn in LDR instructions with register offset syntax (that is the forms that do not writeback to the Rn).

Other uses of PC are not permitted in ARM instructions.

In Thumb instructions you can use PC for Rt in LDR word instructions. Other uses of PC in these Thumb instructions are not permitted.

Use of SP

You can use SP for Rn.

In ARM code, you can use SP for Rt in word instructions. You can use SP for Rt in non-word ARM instructions but this is deprecated in ARMv6T2 and above.

^s Where +/-Rm is shown, you can use -Rm, +Rm, or Rm. Where +Rm is shown, you cannot use -Rm.

^t For word loads, Rt can be the PC. A load to the PC causes a branch to the address loaded. In ARMv4, bits[1:0] of the address loaded must be 0b00. In ARMv5T and above, bits[1:0] must not be 0b10, and if bit[0] is 1, execution continues in Thumb state, otherwise execution continues in ARM state.

^u Rt, Rn, and Rm must all be in the range R0-R7.

You can use SP for Rm in ARM instructions but this is deprecated in ARMv6T2 and above.

In Thumb code, you can use SP for Rt in word instructions only. All other use of SP for Rt in these instructions are not permitted in Thumb code.

Use of SP for Rm is not permitted in Thumb state.

Related concepts

[6.16 Address alignment](#) on page 6-134.

Related references

[11.8 Condition code suffixes](#) on page 11-319.

11.45 LDR (register-relative)

Load register. The address is an offset from a base register.

Syntax

LDR{*type*}{*cond*}{*.W*} *Rt*, *Label*

LDRD{*cond*} *Rt*, *Rt2*, *Label* ; Doubleword

where:

type

can be any one of:

B

unsigned Byte (Zero extend to 32 bits on loads.)

SB

signed Byte (LDR only. Sign extend to 32 bits.)

H

unsigned Halfword (Zero extend to 32 bits on loads.)

SH

signed Halfword (LDR only. Sign extend to 32 bits.)

-

omitted, for Word.

cond

is an optional condition code.

.W

is an optional instruction width specifier.

Rt

is the register to load or store.

Rt2

is the second register to load or store.

Label

is a symbol defined by the FIELD directive. *Label* specifies an offset from the base register which is defined using the MAP directive.

Label must be within a limited distance of the value in the base register.

Offset range and architectures

The assembler calculates the offset from the base register for you. The assembler generates an error if *Label* is out of range.

The following table shows the possible offsets between the label and the current instruction:

Table 11-13 Register-relative offsets

Instruction	Offset range	Architectures
ARM LDR, LDRB ^v	+/- 4095	All
ARM LDRSB, LDRH, LDRSH	+/- 255	All
ARM LDRD	+/- 255	5E
Thumb, 32-bit LDR, LDRB, LDRSB, LDRH, LDRSH ^v	-255 to 4095	T2

^v For word loads, *Rt* can be the PC. A load to the PC causes a branch to the address loaded. In ARMv4, bits[1:0] of the address loaded must be 0b00. In ARMv5T and above, bits[1:0] must not be 0b10, and if bit[0] is 1, execution continues in Thumb state, otherwise execution continues in ARM state.

^w Must be a multiple of 4.

^x *Rt* and base register must be in the range R0-R7.

^y Must be a multiple of 2.

^z *Rt* must be in the range R0-R7.

Table 11-13 Register-relative offsets (continued)

Instruction	Offset range	Architectures
Thumb, 32-bit LDRD	+/- 1020 ^w	T2
Thumb, 16-bit LDR ^x	0 to 124 ^w	T
Thumb, 16-bit LDRH ^x	0 to 62 ^y	T
Thumb, 16-bit LDRB ^x	0 to 31	T
Thumb, 16-bit LDR, base register is SP ^z	0 to 1020 ^w	T

Notes about the Architectures column

Entries in the Architectures column indicate that the instructions are available as follows:

All

All versions of the ARM architecture.

5E

The ARMv5TE, ARMv6*, and ARMv7 architectures.

T2

The ARMv6T2 and above architectures.

T

The ARMv4T, ARMv5T*, ARMv6*, and ARMv7 architectures.

LDR (register-relative) in Thumb

You can use the `.w` width specifier to force LDR to generate a 32-bit instruction in Thumb code. `LDR.w` always generates a 32-bit instruction, even if the target could be reached using a 16-bit LDR.

For forward references, LDR without `.w` always generates a 16-bit instruction in Thumb code, even if that results in failure for a target that could be reached using a 32-bit Thumb LDR instruction.

Doubleword register restrictions

For 32-bit Thumb instructions, you must not specify SP or PC for either `Rt` or `Rt2`.

For ARM instructions:

- `Rt` must be an even-numbered register.
- `Rt` must not be LR.
- ARM strongly recommends that you do not use R12 for `Rt`.
- `Rt2` must be $R(t + 1)$.

Use of PC

You can use PC for `Rt` in word instructions. Other uses of PC are not permitted in these instructions.

Use of SP

In ARM code, you can use SP for `Rt` in word instructions. You can use SP for `Rt` in non-word ARM instructions but this is deprecated in ARMv6T2 and above.

In Thumb code, you can use SP for `Rt` in word instructions only. All other use of SP for `Rt` in these instructions are not permitted in Thumb code.

Related concepts

[7.5 Register-relative and PC-relative expressions on page 7-142.](#)

[6.16 Address alignment on page 6-134.](#)

Related references

[15.29 FIELD on page 15-793.](#)

15.52 MAP on page 15-820.

11.8 Condition code suffixes on page 11-319.

11.46 LDR pseudo-instruction

Load a register with either a 32-bit immediate value or an address.

————— **Note** —————

This describes the LDR pseudo-instruction only, and not the LDR instruction.

Syntax

LDR{*cond*}{.W} *Rt*, =*expr*

LDR{*cond*}{.W} *Rt*, =*Label_expr*

where:

cond

is an optional condition code.

.W

is an optional instruction width specifier.

Rt

is the register to be loaded.

expr

evaluates to a numeric value.

Label_expr

is a PC-relative or external expression of an address in the form of a label plus or minus a numeric value.

Usage

When using the LDR pseudo-instruction:

- If the value of *expr* can be loaded with a valid MOV or MVN instruction, the assembler uses that instruction.
- If a valid MOV or MVN instruction cannot be used, or if the *Label_expr* syntax is used, the assembler places the constant in a literal pool and generates a PC-relative LDR instruction that reads the constant from the literal pool.

————— **Note** —————

- An address loaded in this way is fixed at link time, so the code is not position-independent.
 - The address holding the constant remains valid regardless of where the linker places the ELF section containing the LDR instruction.
-

The assembler places the value of *Label_expr* in a literal pool and generates a PC-relative LDR instruction that loads the value from the literal pool.

If *Label_expr* is an external expression, or is not contained in the current section, the assembler places a linker relocation directive in the object file. The linker generates the address at link time.

If *Label_expr* is either a named or numeric local label, the assembler places a linker relocation directive in the object file and generates a symbol for that local label. The address is generated at link time. If the local label references Thumb code, the Thumb bit (bit 0) of the address is set.

The offset from the PC to the value in the literal pool must be less than $\pm 4\text{KB}$ (in an ARM or 32-bit Thumb encoding) or in the range 0 to $+1\text{KB}$ (16-bit Thumb encoding). You are responsible for ensuring that there is a literal pool within range.

If the label referenced is in Thumb code, the LDR pseudo-instruction sets the Thumb bit (bit 0) of *Label_expr*.

————— **Note** —————

In *RealView Compilation Tools (RVCT) v2.2*, the Thumb bit of the address was not set. If you have code that relies on this behavior, use the command line option `--untyped_local_labels` to force the assembler not to set the Thumb bit when referencing labels in Thumb code.

LDR in Thumb code

You can use the `.w` width specifier to force LDR to generate a 32-bit instruction in Thumb code on ARMv6T2 and above processors. LDR.w always generates a 32-bit instruction, even if the immediate value could be loaded in a 16-bit MOV, or there is a literal pool within reach of a 16-bit PC-relative load.

If the value to be loaded is not known in the first pass of the assembler, LDR without `.w` generates a 16-bit instruction in Thumb code, even if that results in a 16-bit PC-relative load for a value that could be generated in a 32-bit MOV or MVN instruction. However, if the value is known in the first pass, and it can be generated using a 32-bit MOV or MVN instruction, the MOV or MVN instruction is used.

In UAL syntax, the LDR pseudo-instruction never generates a 16-bit flag-setting MOV instruction. Use the `--diag_warning 1727` assembler command line option to check when a 16-bit instruction could have been used.

You can use the MOV32 pseudo-instruction for generating immediate values or addresses without loading from a literal pool.

Examples

```

LDR    r3,=0xff0    ; loads 0xff0 into R3
                    ; => MOV.W r3,#0xff0
LDR    r1,=0xfff    ; loads 0xfff into R1
                    ; => LDR r1,[pc,offset_to_litpool]
                    ;
                    ;     ..
LDR    r2,=place    ; loads the address of
                    ; place into R2
                    ; => LDR r2,[pc,offset_to_litpool]
                    ;
                    ;     ..
                    ;     litpool DCD place

```

Related concepts

[7.3 Numeric constants](#) on page 7-140.

[7.5 Register-relative and PC-relative expressions](#) on page 7-142.

[7.10 Numeric local labels](#) on page 7-147.

Related references

[10.66 --untyped_local_labels](#) on page 10-292.

[11.58 MOV32 pseudo-instruction](#) on page 11-405.

[11.8 Condition code suffixes](#) on page 11-319.

[15.50 LTORG](#) on page 15-816.

11.47 LDR, unprivileged

Unprivileged load byte, halfword, or word.

Syntax

LDR{*type*}T{*cond*} *Rt*, [*Rn* {, #*offset*}] ; immediate offset (32-bit Thumb encoding only)

LDR{*type*}T{*cond*} *Rt*, [*Rn*] {, #*offset*} ; post-indexed (ARM only)

LDR{*type*}T{*cond*} *Rt*, [*Rn*], ±*Rm* {, *shift*} ; post-indexed (register) (ARM only)

where:

type

can be any one of:

B

unsigned Byte (Zero extend to 32 bits on loads.)

SB

signed Byte (Sign extend to 32 bits.)

H

unsigned Halfword (Zero extend to 32 bits on loads.)

SH

signed Halfword (Sign extend to 32 bits.)

-

omitted, for Word.

cond

is an optional condition code.

Rt

is the register to load.

Rn

is the register on which the memory address is based.

offset

is an offset. If offset is omitted, the address is the value in *Rn*.

Rm

is a register containing a value to be used as the offset. *Rm* must not be PC.

shift

is an optional shift.

Operation

When these instructions are executed by privileged software, they access memory with the same restrictions as they would have if they were executed by unprivileged software.

When executed by unprivileged software these instructions behave in exactly the same way as the corresponding load instruction, for example LDRSBT behaves in the same way as LDRSB.

Offset ranges and architectures

The following table shows the ranges of offsets and availability of these instructions.

Table 11-14 Offsets and architectures, LDR (User mode)

Instruction	Immediate offset	Post-indexed	+/- <i>Rm</i> ^{aa}	shift	Arch.
ARM, word or byte	Not available	-4095 to 4095	+/- <i>Rm</i>	LSL #0-31	All
				LSR #1-32	

^{aa} You can use -*Rm*, +*Rm*, or *Rm*.

Table 11-14 Offsets and architectures, LDR (User mode) (continued)

Instruction	Immediate offset	Post-indexed	+/-Rm ^{aa}	shift	Arch.
				ASR #1-32	
				ROR #1-31	
				RRX	
ARM, signed byte, halfword, or signed halfword	Not available	-255 to 255	+/-Rm	Not available	T2
Thumb, 32-bit encoding, word, halfword, signed halfword, byte, or signed byte	0 to 255	Not available	Not available		T2

Notes on the Architecture column

Entries in the Architecture column indicate that the instructions are available as follows:

All

All versions of the ARM architecture.

T2

The ARMv6T2 and above architectures.

Related concepts

[6.16 Address alignment](#) on page 6-134.

Related references

[11.8 Condition code suffixes](#) on page 11-319.

11.48 LDREX

Load Register Exclusive.

Syntax

LDREX{*cond*} *Rt*, [*Rn* {, #*offset*}]

LDREXB{*cond*} *Rt*, [*Rn*]

LDREXH{*cond*} *Rt*, [*Rn*]

LDREXD{*cond*} *Rt*, *Rt2*, [*Rn*]

where:

cond

is an optional condition code.

Rt

is the register to load.

Rt2

is the second register for doubleword loads.

Rn

is the register on which the memory address is based.

offset

is an optional offset applied to the value in *Rn*. *offset* is permitted only in 32-bit Thumb instructions. If *offset* is omitted, an offset of zero is assumed.

Operation

LDREX loads data from memory.

- If the physical address has the Shared TLB attribute, LDREX tags the physical address as exclusive access for the current processor, and clears any exclusive access tag for this processor for any other physical address.
- Otherwise, it tags the fact that the executing processor has an outstanding tagged physical address.

LDREXB and LDREXH zero extend the value loaded.

Restrictions

PC must not be used for any of *Rt*, *Rt2*, or *Rn*.

For ARM instructions:

- SP can be used but use of SP for *Rt* or *Rt2* is deprecated in ARMv6T2 and above.
- For LDREXD, *Rt* must be an even numbered register, and not LR.
- *Rt2* must be $R(t+1)$.
- *offset* is not permitted.

For Thumb instructions:

- SP can be used for *Rn*, but must not be used for *Rt* or *Rt2*.
- For LDREXD, *Rt* and *Rt2* must not be the same register.
- The value of *offset* can be any multiple of four in the range 0-1020.

Usage

Use LDREX and STREX to implement interprocess communication in multiple-processor and shared-memory systems.

For reasons of performance, keep the number of instructions between corresponding LDREX and STREX instructions to a minimum.

Note

The address used in a STREX instruction must be the same as the address in the most recently executed LDREX instruction.

Architectures

ARM LDREX and STREX are available in ARMv6 and above.

ARM LDREXB, LDREXH, LDREXD, STREXB, STREXD, and STREXH are available in ARMv6K and above.

All these 32-bit Thumb instructions are available in ARMv6T2 and above, except that LDREXD and STREXD are not available in the ARMv7-M architecture.

There are no 16-bit versions of these instructions.

Examples

```

MOV r1, #0x1           ; load the 'lock taken' value
try
LDREX r0, [LockAddr]   ; load the lock value
CMP r0, #0             ; is the lock free?
STREXEQ r0, r1, [LockAddr] ; try and claim the lock
CMPEQ r0, #0          ; did this succeed?
BNE try               ; no - try again
....                 ; yes - we have the lock

```

Related concepts

[6.16 Address alignment](#) on page 6-134.

Related references

[11.8 Condition code suffixes](#) on page 11-319.

11.49 LSL

Logical Shift Left. This instruction is a preferred synonym for MOV instructions with shifted register operands.

Syntax

LSL{S}{cond} Rd, Rm, Rs

LSL{S}{cond} Rd, Rm, #sh

where:

S

is an optional suffix. If S is specified, the condition flags are updated on the result of the operation.

Rd

is the destination register.

Rm

is the register holding the first operand. This operand is shifted left.

Rs

is a register holding a shift value to apply to the value in Rm. Only the least significant byte is used.

sh

is a constant shift. The range of values permitted is 0-31.

Operation

LSL provides the value of a register multiplied by a power of two, inserting zeros into the vacated bit positions.

Restrictions in Thumb code

Thumb instructions must not use PC or SP.

You cannot specify zero for the sh value in an LSL instruction in an IT block.

Use of SP and PC in ARM instructions

You can use SP in these ARM instructions but this is deprecated in ARMv6T2 and above.

You cannot use PC in instructions with the LSL{S}{cond} Rd, Rm, Rs syntax. You can use PC for Rd and Rm in the other syntax, but this is deprecated in ARMv6T2 and above.

If you use PC as Rm, the value used is the address of the instruction plus 8.

If you use PC as Rd:

- Execution branches to the address corresponding to the result.
- If you use the S suffix, the SPSR of the current mode is copied to the CPSR. You can use this to return from exceptions.

————— **Note** —————

The ARM instruction LSL{S}{cond} pc, Rm, #sh always disassembles to the preferred form MOV{S}{cond} pc, Rm{, shift}.

————— **Caution** —————

Do not use the S suffix when using PC as Rd in User mode or System mode. The assembler cannot warn you about this because it has no information about what the processor mode is likely to be at execution time.

You cannot use PC for *Rd* or any operand in the LSL instruction if it has a register-controlled shift.

Condition flags

If *S* is specified, the LSL instruction updates the N and Z flags according to the result.

The C flag is unaffected if the shift value is 0. Otherwise, the C flag is updated to the last bit shifted out.

16-bit instructions

The following forms of this instruction are available in Thumb code, and are 16-bit instructions:

LSLS *Rd*, *Rm*, #*sh*

Rd and *Rm* must both be Lo registers. This form can only be used outside an IT block.

LSL{*cond*} *Rd*, *Rm*, #*sh*

Rd and *Rm* must both be Lo registers. This form can only be used inside an IT block.

LSLS *Rd*, *Rd*, *Rs*

Rd and *Rs* must both be Lo registers. This form can only be used outside an IT block.

LSL{*cond*} *Rd*, *Rd*, *Rs*

Rd and *Rs* must both be Lo registers. This form can only be used inside an IT block.

Architectures

This ARM instruction is available in all architectures.

This 32-bit Thumb instruction is available in ARMv6T2 and above.

This 16-bit Thumb instruction is available in ARMv4T and above.

Example

```
LSLS    r1, r2, r3
```

Related references

[11.57 MOV](#) on page 11-403.

[11.8 Condition code suffixes](#) on page 11-319.

11.50 LSR

Logical Shift Right. This instruction is a preferred synonym for MOV instructions with shifted register operands.

Syntax

LSR{S}{cond} Rd, Rm, Rs

LSR{S}{cond} Rd, Rm, #sh

where:

S

is an optional suffix. If S is specified, the condition flags are updated on the result of the operation.

Rd

is the destination register.

Rm

is the register holding the first operand. This operand is shifted right.

Rs

is a register holding a shift value to apply to the value in Rm. Only the least significant byte is used.

sh

is a constant shift. The range of values permitted is 1-32.

Operation

LSR provides the unsigned value of a register divided by a variable power of two, inserting zeros into the vacated bit positions.

Restrictions in Thumb code

Thumb instructions must not use PC or SP.

Use of SP and PC in ARM instructions

You can use SP in these ARM instructions but they are deprecated in ARMv6T2 and above.

You cannot use PC in instructions with the LSR{S}{cond} Rd, Rm, Rs syntax. You can use PC for Rd and Rm in the other syntax, but this is deprecated in ARMv6T2 and above.

If you use PC as Rm, the value used is the address of the instruction plus 8.

If you use PC as Rd:

- Execution branches to the address corresponding to the result.
- If you use the S suffix, the SPSR of the current mode is copied to the CPSR. You can use this to return from exceptions.

————— **Note** —————

The ARM instruction LSRS{cond} pc, Rm, #sh always disassembles to the preferred form MOVS{cond} pc, Rm{, shift}.

—————

————— **Caution** —————

Do not use the S suffix when using PC as Rd in User mode or System mode. The assembler cannot warn you about this because it has no information about what the processor mode is likely to be at execution time.

—————

You cannot use PC for Rd or any operand in the LSR instruction if it has a register-controlled shift.

Condition flags

If S is specified, the instruction updates the N and Z flags according to the result.

The C flag is unaffected if the shift value is 0. Otherwise, the C flag is updated to the last bit shifted out.

16-bit instructions

The following forms of these instructions are available in Thumb code, and are 16-bit instructions:

LSRS *Rd*, *Rm*, #*sh*

Rd and *Rm* must both be Lo registers. This form can only be used outside an IT block.

LSR{*cond*} *Rd*, *Rm*, #*sh*

Rd and *Rm* must both be Lo registers. This form can only be used inside an IT block.

LSRS *Rd*, *Rd*, *Rs*

Rd and *Rs* must both be Lo registers. This form can only be used outside an IT block.

LSR{*cond*} *Rd*, *Rd*, *Rs*

Rd and *Rs* must both be Lo registers. This form can only be used inside an IT block.

Architectures

This ARM instruction is available in all architectures.

This 32-bit Thumb instruction is available in ARMv6T2 and above.

This 16-bit Thumb instruction is available in ARMv4T and above.

Example

```
LSR    r4, r5, r6
```

Related references

[11.57 MOV](#) on page 11-403.

[11.8 Condition code suffixes](#) on page 11-319.

11.51 MAR

Transfer from two general-purpose registers to a 40-bit internal accumulator.

Syntax

`MAR{cond} Acc, RdLo, RdHi`

where:

cond

is an optional condition code.

Acc

is the internal accumulator. The standard name is `accx`, where *x* is an integer in the range 0 to *n*. The value of *n* depends on the processor. It is 0 for current processors.

RdLo, RdHi

are general-purpose registers. *RdLo* and *RdHi* must not be the PC.

Operation

The MAR instruction copies the contents of *RdLo* to bits[31:0] of *Acc*, and the least significant byte of *RdHi* to bits[39:32] of *Acc*.

Architectures

The MAR ARM coprocessor 0 instruction is only available in XScale processors.

There is no Thumb version of the MAR instruction.

Examples

MAR	<code>acc0, r0, r1</code>
MARNE	<code>acc0, r9, r2</code>

Related references

[11.8 Condition code suffixes on page 11-319.](#)

11.52 MCR and MCR2

Move to Coprocessor from ARM Register. Depending on the coprocessor, you might be able to specify various additional operations.

Syntax

`MCR{cond} coproc, #opcode1, Rt, CRn, CRm{, #opcode2}`

`MCR2{cond} coproc, #opcode1, Rt, CRn, CRm{, #opcode2}`

where:

cond

is an optional condition code. In ARM code, *cond* is not permitted for MCR2.

coproc

is the name of the coprocessor the instruction is for. The standard name is *pn*, where *n* is an integer in the range 0 to 15.

opcode1

is a 3-bit coprocessor-specific opcode.

opcode2

is an optional 3-bit coprocessor-specific opcode.

Rt

is an ARM source register. *Rt* must not be PC.

CRn, *CRm*

are coprocessor registers.

Usage

The use of these instructions depends on the coprocessor. See the coprocessor documentation for details.

Architectures

The MCR ARM instruction is available in all versions of the ARM architecture.

The MCR2 ARM instruction is available in ARMv5T and above.

These 32-bit Thumb instructions are available in ARMv6T2 and above.

There are no 16-bit versions of these instructions in Thumb.

Related references

[11.8 Condition code suffixes on page 11-319.](#)

11.53 MCRR and MCRR2

Move to Coprocessor from ARM Registers. Depending on the coprocessor, you might be able to specify various additional operations.

Syntax

`MCRR{cond} coproc, #opcode, Rt, Rt2, CRn`

`MCRR2{cond} coproc, #opcode, Rt, Rt2, CRn`

where:

cond

is an optional condition code. In ARM code, *cond* is not permitted for MCRR2.

coproc

is the name of the coprocessor the instruction is for. The standard name is *pn*, where *n* is an integer in the range 0 to 15.

opcode

is a 4-bit coprocessor-specific opcode.

Rt, *Rt2*

are ARM source registers. *Rt* and *Rt2* must not be PC.

CRn

is a coprocessor register.

Usage

The use of these instructions depends on the coprocessor. See the coprocessor documentation for details.

Architectures

The MCRR ARM instruction is available in ARMv6 and above, and E variants of ARMv5T.

The MCRR2 ARM instruction is available in ARMv6 and above.

These 32-bit Thumb instructions are available in ARMv6T2 and above.

There are no 16-bit versions of these instructions in Thumb.

Related references

[11.8 Condition code suffixes on page 11-319.](#)

11.54 MIA, MIAPH, and MIAxy

Multiply with Internal Accumulate, Multiply with Internal Accumulate, Packed Halfwords.

Syntax

MIA{*cond*} *Acc*, *Rn*, *Rm*

MIAPH{*cond*} *Acc*, *Rn*, *Rm*

MIA<*x*><*y*>{*cond*} *Acc*, *Rn*, *Rm*

where:

cond
 is an optional condition code.

Acc
 is the internal accumulator. The standard name is *accx*, where *x* is an integer in the range 0 to *n*. The value of *n* depends on the processor. It is 0 in current processors.

Rn, *Rm*
 are the ARM registers holding the values to be multiplied.
Rn and *Rm* must not be PC.

<*x*><*y*>
 is one of: BB, BT, TB, TT.

Operation

These instructions multiply either 16-bit or 32-bit signed integers, adding the result to a 40-bit accumulator.

The MIA instruction multiplies the signed integers from *Rn* and *Rm*, and adds the result to the 40-bit value in *Acc*.

The MIAPH instruction multiplies the signed integers from the bottom halves of *Rn* and *Rm*, multiplies the signed integers from the upper halves of *Rn* and *Rm*, and adds the two 32-bit results to the 40-bit value in *Acc*.

The MIAxy instruction multiplies the signed integer from the selected half of *Rs* by the signed integer from the selected half of *Rm*, and adds the 32-bit result to the 40-bit value in *Acc*. <*x*> == B means use the bottom half (bits [15:0]) of *Rn*, <*x*> == T means use the top half (bits [31:16]) of *Rn*. <*y*> == B means use the bottom half (bits [15:0]) of *Rm*, <*y*> == T means use the top half (bits [31:16]) of *Rm*.

Condition flags

These instructions do not change the flags.

————— **Note** —————

These instructions cannot raise an exception. If overflow occurs on these instructions, the result wraps round without any warning.

Architectures

These ARM coprocessor 0 instructions are only available in XScale processors.

There are no Thumb versions of these instructions.

Examples

MIA	acc0, r5, r0
MIALE	acc0, r1, r9
MIAPH	acc0, r0, r7
MIAPHNE	acc0, r11, r10
MIABB	acc0, r8, r9

MIABT	acc0, r8, r8
MIATB	acc0, r5, r3
MIATT	acc0, r0, r6
MIABTGT	acc0, r2, r5

Related references

[11.8 Condition code suffixes on page 11-319.](#)

11.55 MLA

Multiply-Accumulate with signed or unsigned 32-bit operands, giving the least significant 32 bits of the result.

Syntax

MLA{S}{*cond*} *Rd*, *Rn*, *Rm*, *Ra*

where:

cond

is an optional condition code.

S

is an optional suffix. If *S* is specified, the condition flags are updated on the result of the operation.

Rd

is the destination register.

Rn, *Rm*

are registers holding the values to be multiplied.

Ra

is a register holding the value to be added.

Operation

The MLA instruction multiplies the values from *Rn* and *Rm*, adds the value from *Ra*, and places the least significant 32 bits of the result in *Rd*.

Register restrictions

Rn must be different from *Rd* in architectures before ARMv6.

You cannot use PC for any register.

You can use SP in ARM instructions but this is deprecated in ARMv6T2 and above. You cannot use SP in Thumb instructions.

Condition flags

If *S* is specified, the MLA instruction:

- Updates the N and Z flags according to the result.
- Corrupts the C and V flag in ARMv4.
- Does not affect the C or V flag in ARMv5T and above.

Architectures

The MLA ARM instruction is available in all versions of the ARM architecture.

This 32-bit Thumb instruction is available in ARMv6T2 and above.

Example

```
MLA    r10, r2, r1, r5
```

Related references

[11.8 Condition code suffixes on page 11-319.](#)

11.56 MLS

Multiply-Subtract, with signed or unsigned 32-bit operands, giving the least significant 32 bits of the result.

Syntax

`MLS{cond} Rd, Rn, Rm, Ra`

where:

cond

is an optional condition code.

S

is an optional suffix. If *S* is specified, the condition flags are updated on the result of the operation.

Rd

is the destination register.

Rn, Rm

are registers holding the values to be multiplied.

Ra

is a register holding the value to be subtracted from.

Operation

The MLS instruction multiplies the values in *Rn* and *Rm*, subtracts the result from the value in *Ra*, and places the least significant 32 bits of the final result in *Rd*.

Register restrictions

You cannot use PC for any register.

You can use SP in ARM instructions but this is deprecated in ARMv6T2 and above. You cannot use SP in Thumb instructions.

Architectures

The MLS ARM instruction is available in ARMv6T2 and above.

This 32-bit Thumb instruction is available in ARMv6T2 and above.

Example

```
MLS    r4, r5, r6, r7
```

Related references

[11.8 Condition code suffixes on page 11-319.](#)

11.57 MOV

Move.

Syntax

MOV{S}{*cond*} *Rd*, *Operand2*

MOV{*cond*} *Rd*, #*imm16*

where:

S

is an optional suffix. If S is specified, the condition flags are updated on the result of the operation.

cond

is an optional condition code.

Rd

is the destination register.

Operand2

is a flexible second operand.

imm16

is any value in the range 0-65535.

Operation

The MOV instruction copies the value of *Operand2* into *Rd*.

In certain circumstances, the assembler can substitute MVN for MOV, or MOV for MVN. Be aware of this when reading disassembly listings.

Use of PC and SP in 32-bit Thumb encodings

You cannot use PC (R15) for *Rd*, or in *Operand2*, in 32-bit Thumb MOV instructions. With the following exceptions, you cannot use SP (R13) for *Rd*, or in *Operand2*:

- MOV{*cond*}.W *Rd*, SP, where *Rd* is not SP.
- MOV{*cond*}.W SP, *Rm*, where *Rm* is not SP.

Use of PC and SP in 16-bit Thumb encodings

You can use PC or SP in 16-bit Thumb MOV{*cond*} *Rd*, *Rm* instructions but these instructions in which both *Rd* and *Rm* are SP or PC are deprecated in ARMv6T2 and above.

You cannot use PC or SP in any other MOV{S} 16-bit Thumb instructions.

Use of PC and SP in ARM MOV

You cannot use PC for *Rd* or any operand in any data processing instruction that has a register-controlled shift.

In instructions without register-controlled shift, the use of PC is deprecated except for the following cases:

- MOVS PC, LR.
- MOV PC, *Rm* when *Rm* is not PC or SP.
- MOV *Rd*, PC when *Rd* is not PC or SP.

You can use SP for *Rd* or *Rm*. But this is deprecated except for the following cases:

- MOV SP, *Rm* when *Rm* is not PC or SP.
- MOV *Rd*, SP when *Rd* is not PC or SP.

Note

- You cannot use PC for *Rd* in MOV *Rd*, #*imm16* if the #*imm16* value is not a permitted Operand2 value. You can use PC in forms with Operand2 without register-controlled shift.
 - The deprecation of PC and SP in ARM instructions only applies to ARMv6T2 and above.
-

If you use PC as *Rm*, the value used is the address of the instruction plus 8.

If you use PC as *Rd*:

- Execution branches to the address corresponding to the result.
- If you use the S suffix, see the SUBS *pc*, *lr* instruction.

Condition flags

If S is specified, the instruction:

- Updates the N and Z flags according to the result.
- Can update the C flag during the calculation of *Operand2*.
- Does not affect the V flag.

16-bit instructions

The following forms of this instruction are available in Thumb code, and are 16-bit instructions:

MOVS *Rd*, #*imm*

Rd must be a Lo register. *imm* range 0-255. This form can only be used outside an IT block.

MOV{*cond*} *Rd*, #*imm*

Rd must be a Lo register. *imm* range 0-255. This form can only be used inside an IT block.

MOVS *Rd*, *Rm*

Rd and *Rm* must both be Lo registers. This form can only be used outside an IT block.

MOV{*cond*} *Rd*, *Rm*

In architectures before ARMv6, either *Rd* or *Rm*, or both, must be a Hi register. In ARMv6 and above, this restriction does not apply.

Architectures

The #*imm16* form of the ARM instruction is available in ARMv6T2 and above. The other forms of the ARM instruction are available in all versions of the ARM architecture.

This 32-bit Thumb instruction is available in ARMv6T2 and above.

This 16-bit Thumb instruction is available in all T variants of the ARM architecture.

Related concepts

[4.4 Load immediate values using MOV and MVN on page 4-68.](#)

Related references

[11.3 Flexible second operand \(Operand2\) on page 11-312.](#)

[11.141 SUBS *pc*, *lr* on page 11-515.](#)

[11.8 Condition code suffixes on page 11-319.](#)

Related information

[Handling Processor Exceptions.](#)

11.58 MOV32 pseudo-instruction

Load a register with either a 32-bit immediate value or any address.

Syntax

`MOV32{cond} Rd, expr`

where:

cond

is an optional condition code.

Rd

is the register to be loaded. *Rd* must not be SP or PC.

expr

can be any one of the following:

symbol

A label in this or another program area.

#constant

Any 32-bit immediate value.

symbol + *constant*

A label plus a 32-bit immediate value.

Usage

MOV32 always generates two 32-bit instructions, a MOV, MOV_T pair. This enables you to load any 32-bit immediate, or to access the whole 32-bit address space.

The main purposes of the MOV32 pseudo-instruction are:

- To generate literal constants when an immediate value cannot be generated in a single instruction.
- To load a PC-relative or external address into a register. The address remains valid regardless of where the linker places the ELF section containing the MOV32.

————— **Note** —————

An address loaded in this way is fixed at link time, so the code is not position-independent.

MOV32 sets the Thumb bit (bit 0) of the address if the label referenced is in Thumb code.

Architectures

This pseudo-instruction is available in ARMv6T2 and above in both ARM and Thumb.

Examples

```
MOV32 r3, #0xABCDEF12 ; loads 0xABCDEF12 into R3
MOV32 r1, Trigger+12  ; loads the address that is 12 bytes
                       ; higher than the address Trigger into R1
```

Related references

[11.8 Condition code suffixes on page 11-319.](#)

11.59 MOVT

Move Top.

Syntax

MOVT{*cond*} *Rd*, #*imm16*

where:

cond is an optional condition code.

Rd is the destination register.

imm16 is a 16-bit immediate value.

Usage

MOVT writes *imm16* to *Rd*[31:16], without affecting *Rd*[15:0].

You can generate any 32-bit immediate with a MOV, MOVT instruction pair. The assembler implements the MOV32 pseudo-instruction for convenient generation of this instruction pair.

Register restrictions

You cannot use PC in ARM or Thumb instructions.

You can use SP for *Rd* in ARM instructions but this is deprecated.

You cannot use SP in Thumb instructions.

Condition flags

This instruction does not change the flags.

Architectures

This ARM instruction is available in ARMv6T2 and above.

This 32-bit Thumb instruction is available in ARMv6T2 and above.

There is no 16-bit version of this instruction in Thumb.

Related references

[11.58 MOV32 pseudo-instruction on page 11-405.](#)

[11.8 Condition code suffixes on page 11-319.](#)

11.60 MRA

Transfer to two general-purpose registers from a 40-bit internal accumulator.

Syntax

`MRA{cond} RdLo, RdHi, Acc`

where:

cond

is an optional condition code.

Acc

is the internal accumulator. The standard name is `accx`, where *x* is an integer in the range 0 to *n*. The value of *n* depends on the processor. It is 0 for current processors.

RdLo, *RdHi*

are general-purpose registers. *RdLo* and *RdHi* must not be the PC, and they must be different registers.

Operation

The MRA instruction:

- Copies bits[31:0] of *Acc* to *RdLo*.
- Copies bits[39:32] of *Acc* to *RdHi* bits[7:0].
- Sign extends the value by copying bit[39] of *Acc* to bits[31:8] of *RdHi*.

Architectures

The MRA ARM coprocessor 0 instruction is only available in XScale processors.

There is no Thumb version of the MRA instruction.

Examples

```
MRA    r4, r5, acc0
MRAGT r4, r8, acc0
```

Related references

[11.8 Condition code suffixes on page 11-319.](#)

11.61 MRC and MRC2

Move to ARM Register from Coprocessor. Depending on the coprocessor, you might be able to specify various additional operations.

Syntax

`MRC{cond} coproc, #opcode1, Rt, CRn, CRm{, #opcode2}`

`MRC2{cond} coproc, #opcode1, Rt, CRn, CRm{, #opcode2}`

where:

cond

is an optional condition code. In ARM code, *cond* is not permitted for MRC2.

coproc

is the name of the coprocessor the instruction is for. The standard name is *pn*, where *n* is an integer in the range 0 to 15.

opcode1

is a 3-bit coprocessor-specific opcode.

opcode2

is an optional 3-bit coprocessor-specific opcode.

Rt

is the ARM destination register. *Rt* must not be PC.

Rt can be `APSR_nzcv`. This means that the coprocessor executes an instruction that changes the value of the condition flags in the APSR.

CRn, *CRm*

are coprocessor registers.

Usage

The use of these instructions depends on the coprocessor. See the coprocessor documentation for details.

Architectures

The MRC ARM instruction is available in all versions of the ARM architecture.

The MRC2 ARM instruction is available in ARMv5T and above.

These 32-bit Thumb instructions are available in ARMv6T2 and above.

There are no 16-bit versions of these instructions in Thumb.

Related references

[11.8 Condition code suffixes on page 11-319.](#)

11.62 MRRC and MRRC2

Move to ARM Registers from Coprocessor. Depending on the coprocessor, you might be able to specify various additional operations.

Syntax

`MRRC{cond} coproc, #opcode, Rt, Rt2, CRm`

`MRRC2{cond} coproc, #opcode, Rt, Rt2, CRm`

where:

cond

is an optional condition code. In ARM code, *cond* is not permitted for MRRC2.

coproc

is the name of the coprocessor the instruction is for. The standard name is *pn*, where *n* is an integer in the range 0 to 15.

opcode

is a 4-bit coprocessor-specific opcode.

Rt, *Rt2*

are ARM destination registers. *Rt* and *Rt2* must not be PC.

CRm

is a coprocessor register.

Usage

The use of these instructions depends on the coprocessor. See the coprocessor documentation for details.

Architectures

The MRRC ARM instruction is available in ARMv6 and above, and E variants of ARMv5T.

The MRRC2 ARM instruction is available in ARMv6 and above.

These 32-bit Thumb instructions are available in ARMv6T2 and above.

There are no 16-bit versions of these instructions in Thumb.

Related references

[11.8 Condition code suffixes on page 11-319.](#)

11.63 MRS (PSR to general-purpose register)

Move the contents of a PSR to a general-purpose register.

Syntax

`MRS{cond} Rd, psr`

where:

cond

is an optional condition code.

Rd

is the destination register.

psr

is one of:

APSR

on any processor, in any mode.

CPSR

deprecated synonym for APSR and for use in Debug state, on any processor except ARMv7-M and ARMv6-M.

SPSR

on any processor except ARMv7-M and ARMv6-M, in privileged software execution only.

Mpsr

on ARMv7-M and ARMv6-M processors only.

Mpsr

can be any of: IPSR, EPSR, IEPSR, IAPSR, EAPSR, MSP, PSP, XPSR, PRIMASK, BASEPRI, BASEPRI_MAX, FAULTMASK, or CONTROL.

Usage

Use MRS in combination with MSR as part of a read-modify-write sequence for updating a PSR, for example to change processor mode, or to clear the Q flag.

In process swap code, the programmers' model state of the process being swapped out must be saved, including relevant PSR contents. Similarly, the state of the process being swapped in must also be restored. These operations make use of MRS/store and load/MSR instruction sequences.

SPSR

You must not attempt to access the SPSR when the processor is in User or System mode. This is your responsibility. The assembler cannot warn you about this, because it has no information about the processor mode at execution time.

CPSR

ARM deprecates reading the CPSR endianness bit (E) with an MRS instruction.

The CPSR execution state bits, other than the E bit, can only be read when the processor is in Debug state, halting debug-mode. Otherwise, the execution state bits in the CPSR read as zero.

The condition flags can be read in any mode on any processor. Use APSR if you are only interested in accessing the condition flags in User mode.

Register restrictions

You cannot use PC for *Rd* in ARM instructions. You can use SP for *Rd* in ARM instructions but this is deprecated in ARMv6T2 and above.

You cannot use PC or SP for *Rd* in Thumb instructions.

Condition flags

This instruction does not change the flags.

Architectures

This ARM instruction is available in all versions of the ARM architecture.

This 32-bit Thumb instruction is available in ARMv6T2 and above.

There is no 16-bit version of this instruction in Thumb.

Related concepts

[2.18 Current Program Status Register on page 2-53.](#)

Related references

[11.64 MRS \(system coprocessor register to ARM register\) on page 11-412.](#)

[11.65 MSR \(ARM register to system coprocessor register\) on page 11-413.](#)

[11.66 MSR \(general-purpose register to PSR\) on page 11-414.](#)

[11.8 Condition code suffixes on page 11-319.](#)

11.64 MRS (system coprocessor register to ARM register)

Move to ARM register from system coprocessor register.

Syntax

`MRS{cond} Rn, coproc_register`

`MRS{cond} APSR_nzcv, special_register`

where:

cond

is an optional condition code.

coproc_register

is the name of the coprocessor register.

special_register

is the name of the coprocessor register that can be written to APSR_nzcv. This is only possible for the coprocessor register DBGDSCRint.

Rn

is the ARM destination register. *Rn* must not be PC.

Usage

You can use this pseudo-instruction to read CP14 or CP15 coprocessor registers, with the exception of write-only registers. A complete list of the applicable coprocessor register names is in the *ARMv7-AR Architecture Reference Manual*. For example:

```
MRS R1, SCTLR ; writes the contents of the CP15 coprocessor
               ; register SCTLR into R1
```

Architectures

This pseudo-instruction is available in ARMv7-A and ARMv7-R in ARM and 32-bit Thumb code.

There is no 16-bit version of this pseudo-instruction in Thumb.

Related references

[11.63 MRS \(PSR to general-purpose register\)](#) on page 11-410.

[11.65 MSR \(ARM register to system coprocessor register\)](#) on page 11-413.

[11.66 MSR \(general-purpose register to PSR\)](#) on page 11-414.

[11.8 Condition code suffixes](#) on page 11-319.

Related information

[ARM Architecture Reference Manual](#).

11.65 MSR (ARM register to system coprocessor register)

Move to system coprocessor register from ARM register.

Syntax

```
MSR{cond} coproc_register, Rn
```

where:

cond

is an optional condition code.

coproc_register

is the name of the coprocessor register.

Rn

is the ARM source register. *Rn* must not be PC.

Usage

You can use this pseudo-instruction to write to any CP14 or CP15 coprocessor writable register. A complete list of the applicable coprocessor register names is in the *ARMv7-AR Architecture Reference Manual*. For example:

```
MSR SCTLr, R1 ; writes the contents of R1 into the CP15
               ; coprocessor register SCTLr
```

Architectures

This pseudo-instruction is available in ARMv7-A and ARMv7-R in ARM and 32-bit Thumb code.

There is no 16-bit version of this pseudo-instruction in Thumb.

Related references

[11.63 MRS \(PSR to general-purpose register\)](#) on page 11-410.

[11.64 MRS \(system coprocessor register to ARM register\)](#) on page 11-412.

[11.66 MSR \(general-purpose register to PSR\)](#) on page 11-414.

[11.8 Condition code suffixes](#) on page 11-319.

[11.150 SYS](#) on page 11-526.

Related information

[ARM Architecture Reference Manual](#).

11.66 MSR (general-purpose register to PSR)

Load an immediate value, or the contents of a general-purpose register, into the specified fields of a Program Status Register (PSR).

Syntax

`MSR{cond} APSR_flags, Rm`

where:

cond

is an optional condition code.

flags

specifies the APSR flags to be moved. *flags* can be one or more of:

nzcvq

ALU flags field mask, PSR[31:27] (User mode)

g

SIMD GE flags field mask, PSR[19:16] (User mode).

Rm

is the source register. *Rm* must not be PC.

Syntax

You can also use the following syntax on architectures other than ARMv7-M and ARMv6-M:

`MSR{cond} APSR_flags, #constant`

`MSR{cond} psr_fields, #constant`

`MSR{cond} psr_fields, Rm`

where:

cond

is an optional condition code.

flags

specifies the APSR flags to be moved. *flags* can be one or more of:

nzcvq

ALU flags field mask, PSR[31:27] (User mode)

g

SIMD GE flags field mask, PSR[19:16] (User mode).

constant

is an expression evaluating to a numeric value. The value must correspond to an 8-bit pattern rotated by an even number of bits within a 32-bit word. Not available in Thumb.

Rm

is the source register. *Rm* must not be PC.

psr

is one of:

CPSR

for use in Debug state, also deprecated synonym for APSR

SPSR

on any processor, in privileged software execution only.

fields

specifies the SPSR or CPSR fields to be moved. *fields* can be one or more of:

c

control field mask byte, PSR[7:0] (privileged software execution)

x

extension field mask byte, PSR[15:8] (privileged software execution)

s status field mask byte, PSR[23:16] (privileged software execution)
f flags field mask byte, PSR[31:24] (privileged software execution).

Syntax

You can also use the following syntax on ARMv7-M and ARMv6-M only:

`MSR{cond} psr, Rm`

where:

cond

is an optional condition code.

Rm

is the source register. *Rm* must not be PC.

psr

can be any of: APSR, IPSR, EPSR, IEPSR, IAPSR, EAPSR, XPSR, MSP, PSP, PRIMASK, BASEPRI, BASEPRI_MAX, FAULTMASK, or CONTROL.

Usage

In User mode:

- Use APSR to access the condition flags, Q, or GE bits.
- Writes to unallocated, privileged or execution state bits in the CPSR are ignored. This ensures that User mode programs cannot change to privileged software execution.

ARM deprecates using MSR to change the endianness bit (E) of the CPSR, in any mode.

You must not attempt to access the SPSR when the processor is in User or System mode.

Register restrictions

You cannot use PC in ARM instructions. You can use SP for *Rm* in ARM instructions but this is deprecated in ARMv6T2 and above.

You cannot use PC or SP in Thumb instructions.

Condition flags

This instruction updates the flags explicitly if the APSR_nzcvq or CPSR_f field is specified.

Architectures

This ARM instruction is available in all versions of the ARM architecture.

This 32-bit Thumb instruction is available in ARMv6T2 and above.

There is no 16-bit version of this instruction in Thumb.

Related references

[11.63 MRS \(PSR to general-purpose register\)](#) on page 11-410.

[11.64 MRS \(system coprocessor register to ARM register\)](#) on page 11-412.

[11.65 MSR \(ARM register to system coprocessor register\)](#) on page 11-413.

[11.8 Condition code suffixes](#) on page 11-319.

11.67 MUL

Multiply with signed or unsigned 32-bit operands, giving the least significant 32 bits of the result.

Syntax

MUL{S}{cond} {Rd}, Rn, Rm

where:

cond

is an optional condition code.

S

is an optional suffix. If *S* is specified, the condition flags are updated on the result of the operation.

Rd

is the destination register.

Rn, Rm

are registers holding the values to be multiplied.

Operation

The MUL instruction multiplies the values from *Rn* and *Rm*, and places the least significant 32 bits of the result in *Rd*.

Register restrictions

Rn must be different from *Rd* in architectures before ARMv6.

You cannot use PC for any register.

You can use SP in ARM instructions but this is deprecated in ARMv6T2 and above. You cannot use SP in Thumb instructions.

Condition flags

If *S* is specified, the MUL instruction:

- Updates the N and Z flags according to the result.
- Corrupts the C and V flag in ARMv4.
- Does not affect the C or V flag in ARMv5T and above.

16-bit instructions

The following forms of the MUL instruction are available in Thumb code, and are 16-bit instructions:

MULS *Rd, Rn, Rd*

Rd and *Rn* must both be Lo registers. This form can only be used outside an IT block.

MUL{cond} *Rd, Rn, Rd*

Rd and *Rn* must both be Lo registers. This form can only be used inside an IT block.

Architectures

This ARM instruction is available in all versions of the ARM architecture.

MUL is available in a 32-bit encoding in Thumb in ARMv6T2 and above. MULS is not available in a 32-bit encoding in Thumb.

This 16-bit Thumb instruction is available in all T variants of the ARM architecture.

Examples

MUL	r10, r2, r5
MULS	r0, r2, r2
MULLT	r2, r3, r2

Related references

[11.8 Condition code suffixes](#) on page 11-319.

11.68 MVN

Move Not.

Syntax

MVN{S}{*cond*} *Rd*, *Operand2*

where:

S

is an optional suffix. If S is specified, the condition flags are updated on the result of the operation.

cond

is an optional condition code.

Rd

is the destination register.

Operand2

is a flexible second operand.

Operation

The MVN instruction takes the value of *Operand2*, performs a bitwise logical NOT operation on the value, and places the result into *Rd*.

In certain circumstances, the assembler can substitute MVN for MOV, or MOV for MVN. Be aware of this when reading disassembly listings.

Use of PC and SP in 32-bit Thumb MVN

You cannot use PC (R15) for *Rd*, or in *Operand2*, in 32-bit Thumb MVN instructions. You cannot use SP (R13) for *Rd*, or in *Operand2*.

Use of PC and SP in 16-bit Thumb instructions

You cannot use PC or SP in any MVN{S} 16-bit Thumb instructions.

Use of PC and SP in ARM MVN

You cannot use PC for *Rd* or any operand in any data processing instruction that has a register-controlled shift.

In instructions without register-controlled shift, use of PC is deprecated.

You can use SP for *Rd* or *Rm*, but this is deprecated.

————— **Note** —————

The deprecation of PC and SP in ARM instructions only applies to ARMv6T2 and above.

If you use PC as *Rm*, the value used is the address of the instruction plus 8.

If you use PC as *Rd*:

- Execution branches to the address corresponding to the result.
- If you use the S suffix, see the SUBS *pc, 1r* instruction.

Condition flags

If S is specified, the instruction:

- Updates the N and Z flags according to the result.
- Can update the C flag during the calculation of *Operand2*.
- Does not affect the V flag.

16-bit instructions

The following forms of this instruction are available in Thumb code, and are 16-bit instructions:

`MVNS Rd, Rm`

Rd and *Rm* must both be Lo registers. This form can only be used outside an IT block.

`MVN{cond} Rd, Rm`

Rd and *Rm* must both be Lo registers. This form can only be used inside an IT block.

Architectures

This ARM instruction is available in all versions of the ARM architecture.

This 32-bit Thumb instruction is available in ARMv6T2 and above.

This 16-bit Thumb instruction is available in all T variants of the ARM architecture.

Correct example

```
MVNNE    r11, #0xF000000B ; ARM only. This immediate value is not available in Thumb.
```

Incorrect example

```
MVN      pc,r3,ASR r0      ; PC not permitted with register-controlled shift
```

Related concepts

[4.4 Load immediate values using MOV and MVN](#) on page 4-68.

Related references

[11.3 Flexible second operand \(Operand2\)](#) on page 11-312.

[11.141 SUBS pc, lr](#) on page 11-515.

[11.8 Condition code suffixes](#) on page 11-319.

Related information

[Handling Processor Exceptions.](#)

11.69 NEG pseudo-instruction

Negate the value in a register.

Syntax

NEG{*cond*} *Rd*, *Rm*

where:

cond
is an optional condition code.

Rd
is the destination register.

Rm
is the register containing the value that is subtracted from zero.

Operation

The NEG pseudo-instruction negates the value in one register and stores the result in a second register.

NEG{*cond*} *Rd*, *Rm* assembles to RSBS{*cond*} *Rd*, *Rm*, #0.

Architectures

The ARM encoding of this pseudo-instruction is available in all versions of the ARM architecture.

The 32-bit Thumb encoding of this pseudo-instruction is available in ARMv6T2 and later.

Register restrictions

In ARM instructions, using SP or PC for *Rd* or *Rm* is deprecated. In Thumb instructions, you cannot use SP or PC for *Rd* or *Rm*.

Condition flags

This pseudo-instruction updates the condition flags, based on the result.

Related references

[11.10 ADD on page 11-322.](#)

11.70 NOP

No Operation.

Syntax

`NOP{cond}`

where:

cond

is an optional condition code.

Usage

NOP does nothing. If NOP is not implemented as a specific instruction on your target architecture, the assembler treats it as a pseudo-instruction and generates an alternative instruction that does nothing, such as `MOV r0, r0` (ARM) or `MOV r8, r8` (Thumb).

NOP is not necessarily a time-consuming NOP. The processor might remove it from the pipeline before it reaches the execution stage.

You can use NOP for padding, for example to place the following instruction on a 64-bit boundary in ARM, or a 32-bit boundary in Thumb.

Architectures

This ARM instruction is available in ARMv6K and above.

This 32-bit Thumb instruction is available in ARMv6T2 and above.

This 16-bit Thumb instruction is available in ARMv6T2 and above.

NOP is available on all other ARM and Thumb architectures as a pseudo-instruction.

Related references

[11.8 Condition code suffixes](#) on page 11-319.

11.71 ORN (Thumb only)

Logical OR NOT.

Syntax

ORN{S}{*cond*} *Rd*, *Rn*, *Operand2*

where:

S

is an optional suffix. If S is specified, the condition flags are updated on the result of the operation.

cond

is an optional condition code.

Rd

is the destination register.

Rn

is the register holding the first operand.

Operand2

is a flexible second operand.

Operation

The ORN Thumb instruction performs an OR operation on the bits in *Rn* with the complements of the corresponding bits in the value of *Operand2*.

In certain circumstances, the assembler can substitute ORN for ORR, or ORR for ORN. Be aware of this when reading disassembly listings.

Use of PC

You cannot use PC (R15) for *Rd* or any operand in the ORN instruction.

Condition flags

If S is specified, the ORN instruction:

- Updates the N and Z flags according to the result.
- Can update the C flag during the calculation of *Operand2*.
- Does not affect the V flag.

Examples

```
ORN    r7, r11, lr, ROR #4
ORNS  r7, r11, lr, ASR #32
```

Architectures

This 32-bit Thumb instruction is available in ARMv6T2 and above.

There is no ARM or 16-bit Thumb ORN instruction.

Related references

[11.3 Flexible second operand \(*Operand2*\) on page 11-312.](#)

[11.141 SUBS pc, lr on page 11-515.](#)

[11.8 Condition code suffixes on page 11-319.](#)

Related information

[Handling Processor Exceptions.](#)

11.72 ORR

Logical OR.

Syntax

ORR{S}{*cond*} *Rd*, *Rn*, *Operand2*

where:

S

is an optional suffix. If S is specified, the condition flags are updated on the result of the operation.

cond

is an optional condition code.

Rd

is the destination register.

Rn

is the register holding the first operand.

Operand2

is a flexible second operand.

Operation

The ORR instruction performs bitwise OR operations on the values in *Rn* and *Operand2*.

In certain circumstances, the assembler can substitute ORN for ORR, or ORR for ORN. Be aware of this when reading disassembly listings.

Use of PC in 32-bit Thumb instructions

You cannot use PC (R15) for *Rd* or any operand with the ORR instruction.

Use of PC and SP in ARM instructions

You can use PC and SP with the ORR instruction but this is deprecated in ARMv6T2 and above.

If you use PC as *Rn*, the value used is the address of the instruction plus 8.

If you use PC as *Rd*:

- Execution branches to the address corresponding to the result.
- If you use the S suffix, see the SUBS *pc*, *l_r* instruction.

You cannot use PC for any operand in any data processing instruction that has a register-controlled shift.

Condition flags

If S is specified, the ORR instruction:

- Updates the N and Z flags according to the result.
- Can update the C flag during the calculation of *Operand2*.
- Does not affect the V flag.

16-bit instructions

The following forms of the ORR instruction are available in Thumb code, and are 16-bit instructions:

ORRS *Rd*, *Rd*, *Rm*

Rd and *Rm* must both be Lo registers. This form can only be used outside an IT block.

ORR{*cond*} *Rd*, *Rd*, *Rm*

Rd and *Rm* must both be Lo registers. This form can only be used inside an IT block.

It does not matter if you specify ORR{S} *Rd*, *Rm*, *Rd*. The instruction is the same.

Example

```
ORREQ r2, r0, r5
```

Related references

[11.3 Flexible second operand \(Operand2\)](#) on page 11-312.

[11.141 SUBS pc, lr](#) on page 11-515.

[11.8 Condition code suffixes](#) on page 11-319.

Related information

[Handling Processor Exceptions.](#)

11.73 PKHBT and PKHTB

Halfword Packing instructions that combine a halfword from one register with a halfword from another register. One of the operands can be shifted before extraction of the halfword.

Syntax

```
PKHBT{cond} {Rd}, Rn, Rm{, LSL #Leftshift}
```

```
PKHTB{cond} {Rd}, Rn, Rm{, ASR #rightshift}
```

where:

PKHBT

Combines bits[15:0] of *Rn* with bits[31:16] of the shifted value from *Rm*.

PKHTB

Combines bits[31:16] of *Rn* with bits[15:0] of the shifted value from *Rm*.

cond

is an optional condition code.

Rd

is the destination register.

Rn

is the register holding the first operand.

Rm

is the register holding the second operand.

Leftshift

is in the range 0 to 31.

rightshift

is in the range 1 to 32.

Register restrictions

You cannot use PC for any register.

You can use SP in ARM instructions but this is deprecated in ARMv6T2 and above. You cannot use SP in Thumb instructions.

Condition flags

These instructions do not change the flags.

Architectures

These ARM instructions are available in ARMv6 and above.

These 32-bit Thumb instructions are available in ARMv6T2 and above. For the ARMv7-M architecture, they are only available in an ARMv7E-M implementation.

There are no 16-bit versions of these instructions in Thumb.

Correct examples

```

PKHBT  r0, r3, r5          ; combine the bottom halfword of R3
                          ; with the top halfword of R5
PKHBT  r0, r3, r5, LSL #16 ; combine the bottom halfword of R3
                          ; with the bottom halfword of R5
PKHTB  r0, r3, r5, ASR #16 ; combine the top halfword of R3
                          ; with the top halfword of R5

```

You can also scale the second operand by using different values of shift.

Incorrect example

```

PKHBTBTEQ r4, r5, r1, ASR #8 ; ASR not permitted with PKHBT

```

Related references

[11.8 Condition code suffixes](#) on page 11-319.

11.74 PLD, PLDW, and PLI

Preload Data and Preload Instruction allow the processor to signal the memory system that a data or instruction load from an address is likely in the near future.

Syntax

$PLtype\{cond\} [Rn \{, \#offset\}]$

$PLtype\{cond\} [Rn, \pm Rm \{, shift\}]$

$PLtype\{cond\} Label$

where:

type

can be one of:

D

Data address.

DW

Data address with intention to write.

I

Instruction address.

type cannot be DW if the syntax specifies *Label*.

cond

is an optional condition code.

Note

cond is permitted only in Thumb code, using a preceding IT instruction. This is an unconditional instruction in ARM code and you must not use *cond*.

Rn

is the register on which the memory address is based.

offset

is an immediate offset. If offset is omitted, the address is the value in *Rn*.

Rm

is a register containing a value to be used as the offset.

shift

is an optional shift.

Label

is a PC-relative expression.

Range of offsets

The offset is applied to the value in *Rn* before the preload takes place. The result is used as the memory address for the preload. The range of offsets permitted is:

- -4095 to +4095 for ARM instructions.
- -255 to +4095 for Thumb instructions, when *Rn* is not PC.
- -4095 to +4095 for Thumb instructions, when *Rn* is PC.

The assembler calculates the offset from the PC for you. The assembler generates an error if *Label* is out of range.

Register or shifted register offset

In ARM code, the value in *Rm* is added to or subtracted from the value in *Rn*. In Thumb code, the value in *Rm* can only be added to the value in *Rn*. The result is used as the memory address for the preload.

The range of shifts permitted is:

- LSL #0 to #3 for Thumb instructions.
- Any one of the following for ARM instructions:
 - LSL #0 to #31.
 - LSR #1 to #32.
 - ASR #1 to #32.
 - ROR #1 to #31.
 - RRX.

Address alignment for preloads

No alignment checking is performed for preload instructions.

Register restrictions

Rm must not be PC. For Thumb instructions *Rm* must also not be SP.

Rn must not be PC for Thumb instructions of the syntax `PLtype{cond} [Rn, ±Rm{, #shift}]`.

Architectures

ARM PLD is available in ARMv5TE and above.

The 32-bit Thumb encoding of PLD is available in ARMv6T2 and above.

PLDW is available only in ARMv7 and above that implement the Multiprocessing Extensions.

PLI is available only in ARMv7 and above.

There are no 16-bit encodings of PLD, PLDW, or PLI in Thumb.

These are hint instructions, and their implementation is optional. If they are not implemented, they execute as NOPs.

Related concepts

[7.5 Register-relative and PC-relative expressions on page 7-142.](#)

Related references

[11.8 Condition code suffixes on page 11-319.](#)

11.75 POP

Pop registers off a full descending stack.

Syntax

POP{*cond*} *reglist*

where:

cond

is an optional condition code.

reglist

is a non-empty list of registers, enclosed in braces. It can contain register ranges. It must be comma separated if it contains more than one register or register range.

Operation

POP is a synonym for LDMIA *sp!* *reglist*. POP is the preferred mnemonic.

Note

LDM and LDMFD are synonyms of LDMIA.

Registers are stored on the stack in numerical order, with the lowest numbered register at the lowest address.

POP, with *reglist* including the PC

This instruction causes a branch to the address popped off the stack into the PC. This is usually a return from a subroutine, where the LR was pushed onto the stack at the start of the subroutine.

In ARMv5T and above:

- Bits[1:0] must not be 0b10.
- If bit[0] is 1, execution continues in Thumb state.
- If bit[0] is 0, execution continues in ARM state.

In ARMv4, bits[1:0] of the address loaded must be 0b00.

Thumb instructions

A subset of these instructions are available in the Thumb instruction set.

The following restriction applies to the 16-bit POP instruction:

- *reglist* can only include the Lo registers and the PC.

The following restrictions apply to the 32-bit POP instruction:

- *reglist* must not include the SP.
- *reglist* can include either the LR or the PC, but not both.

Restrictions on *reglist* in ARM instructions

ARM POP instructions cannot have SP but can have PC in the *reglist*. These instructions that include both PC and LR in the *reglist* are deprecated in ARMv6T2 and above.

Example

```
POP    {r0,r10,pc} ; no 16-bit version available
```

Related references

[11.41 LDM on page 11-372.](#)

11.76 PUSH on page 11-431.

11.8 Condition code suffixes on page 11-319.

11.76 PUSH

Push registers onto a full descending stack.

Syntax

`PUSH{cond} reglist`

where:

cond

is an optional condition code.

reglist

is a non-empty list of registers, enclosed in braces. It can contain register ranges. It must be comma separated if it contains more than one register or register range.

Operation

PUSH is a synonym for `STMDB sp!, reglist`. PUSH is the preferred mnemonic.

Note

STMFD is a synonym of STMDB.

Registers are stored on the stack in numerical order, with the lowest numbered register at the lowest address.

Thumb instructions

The following restriction applies to the 16-bit PUSH instruction:

- *reglist* can only include the Lo registers and the LR.

The following restrictions apply to the 32-bit PUSH instruction:

- *reglist* must not include the SP.
- *reglist* must not include the PC.

Restrictions on reglist in ARM instructions

ARM PUSH instructions can have SP and PC in the *reglist* but these instructions that include SP or PC in the *reglist* are deprecated in ARMv6T2 and above.

Examples

PUSH	{r0, r4-r7}
PUSH	{r2, lr}

Related references

[11.41 LDM on page 11-372.](#)

[11.75 POP on page 11-429.](#)

[11.8 Condition code suffixes on page 11-319.](#)

11.77 QADD

Signed saturating addition.

Syntax

QADD{*cond*} {*Rd*}, *Rm*, *Rn*

where:

cond
is an optional condition code.

Rd
is the destination register.

Rm, *Rn*
are the registers holding the operands.

Operation

The QADD instruction adds the values in *Rm* and *Rn*. It saturates the result to the signed range $-2^{31} \leq x \leq 2^{31}-1$.

Note

All values are treated as two's complement signed integers by this instruction.

Register restrictions

You cannot use PC for any operand.

You can use SP in ARM instructions but this is deprecated in ARMv6T2 and above. You cannot use SP in Thumb instructions.

Q flag

If saturation occurs, this instruction sets the Q flag. To read the state of the Q flag, use an MRS instruction.

Architectures

This ARM instruction is available in ARMv6 and above, and E variants of ARMv5T.

This 32-bit Thumb instruction is available in ARMv6T2 and above. For the ARMv7-M architecture, it is only available in an ARMv7E-M implementation.

There is no 16-bit version of this instruction in Thumb.

Example

```
QADD    r0, r1, r9
```

Related concepts

[2.17 The Q flag on page 2-52.](#)

Related references

[11.63 MRS \(PSR to general-purpose register\) on page 11-410.](#)

[11.8 Condition code suffixes on page 11-319.](#)

11.78 QADD8

Signed saturating parallel byte-wise addition.

Syntax

QADD8{*cond*} {*Rd*}, *Rn*, *Rm*

where:

cond
is an optional condition code.

Rd
is the destination register.

Rm, *Rn*
are the ARM registers holding the operands.

Operation

This instruction performs four signed integer additions on the corresponding bytes of the operands and writes the results into the corresponding bytes of the destination. It saturates the results to the signed range $-2^7 \leq x \leq 2^7 - 1$. The Q flag is not affected even if this operation saturates.

Register restrictions

You cannot use PC for any register.

You can use SP in ARM instructions but this is deprecated in ARMv6T2 and above. You cannot use SP in Thumb instructions.

Condition flags

This instruction does not affect the N, Z, C, V, Q, or GE flags.

Architectures

This ARM instruction is available in ARMv6 and above.

This 32-bit Thumb instruction is available in ARMv6T2 and above. For the ARMv7-M architecture, it is only available in an ARMv7E-M implementation.

There is no 16-bit version of this instruction in Thumb.

Related concepts

[2.17 The Q flag on page 2-52.](#)

Related references

[11.8 Condition code suffixes on page 11-319.](#)

11.79 QADD16

Signed saturating parallel halfword-wise addition.

Syntax

QADD16{*cond*} {*Rd*}, *Rn*, *Rm*

where:

cond
is an optional condition code.

Rd
is the destination register.

Rm, *Rn*
are the ARM registers holding the operands.

Operation

This instruction performs two signed integer additions on the corresponding halfwords of the operands and writes the results into the corresponding halfwords of the destination. It saturates the results to the signed range $-2^{15} \leq x \leq 2^{15} - 1$. The Q flag is not affected even if this operation saturates.

Register restrictions

You cannot use PC for any register.

You can use SP in ARM instructions but this is deprecated in ARMv6T2 and above. You cannot use SP in Thumb instructions.

Condition flags

This instruction does not affect the N, Z, C, V, Q, or GE flags.

Architectures

This ARM instruction is available in ARMv6 and above.

This 32-bit Thumb instruction is available in ARMv6T2 and above. For the ARMv7-M architecture, it is only available in an ARMv7E-M implementation.

There is no 16-bit version of this instruction in Thumb.

Related concepts

[2.17 The Q flag on page 2-52.](#)

Related references

[11.8 Condition code suffixes on page 11-319.](#)

11.80 QASX

Signed saturating parallel add and subtract halfwords with exchange.

Syntax

`QASX{cond} {Rd}, Rn, Rm`

where:

cond
is an optional condition code.

Rd
is the destination register.

Rm, Rn
are the ARM registers holding the operands.

Operation

This instruction exchanges the two halfwords of the second operand, then performs an addition on the two top halfwords of the operands and a subtraction on the bottom two halfwords. It writes the results into the corresponding halfwords of the destination. It saturates the results to the signed range $-2^{15} \leq x \leq 2^{15} - 1$. The Q flag is not affected even if this operation saturates.

Register restrictions

You cannot use PC for any register.

You can use SP in ARM instructions but this is deprecated in ARMv6T2 and above. You cannot use SP in Thumb instructions.

Condition flags

This instruction does not affect the N, Z, C, V, Q, or GE flags.

Architectures

This ARM instruction is available in ARMv6 and above.

This 32-bit Thumb instruction is available in ARMv6T2 and above. For the ARMv7-M architecture, it is only available in an ARMv7E-M implementation.

There is no 16-bit version of this instruction in Thumb.

Related concepts

[2.17 The Q flag on page 2-52.](#)

Related references

[11.8 Condition code suffixes on page 11-319.](#)

11.81 QDADD

Signed saturating Double and Add.

Syntax

QDADD{*cond*} {*Rd*}, *Rm*, *Rn*

where:

cond

is an optional condition code.

Rd

is the destination register.

Rm, *Rn*

are the registers holding the operands.

Operation

QDADD calculates $SAT(Rm + SAT(Rn * 2))$. It saturates the result to the signed range $-2^{31} \leq x \leq 2^{31}-1$. Saturation can occur on the doubling operation, on the addition, or on both. If saturation occurs on the doubling but not on the addition, the Q flag is set but the final result is unsaturated.

Note

All values are treated as two's complement signed integers by this instruction.

Register restrictions

You cannot use PC for any operand.

You can use SP in ARM instructions but this is deprecated in ARMv6T2 and above. You cannot use SP in Thumb instructions.

Q flag

If saturation occurs, this instruction sets the Q flag. To read the state of the Q flag, use an MRS instruction.

Architectures

This ARM instruction is available in ARMv6 and above, and E variants of ARMv5T.

This 32-bit Thumb instruction is available in ARMv6T2 and above. For the ARMv7-M architecture, it is only available in an ARMv7E-M implementation.

There is no 16-bit version of this instruction in Thumb.

Related concepts

[2.17 The Q flag on page 2-52.](#)

Related references

[11.63 MRS \(PSR to general-purpose register\) on page 11-410.](#)

[11.8 Condition code suffixes on page 11-319.](#)

11.82 QDSUB

Signed saturating Double and Subtract.

Syntax

QDSUB{*cond*} {*Rd*}, *Rm*, *Rn*

where:

cond
is an optional condition code.

Rd
is the destination register.

Rm, *Rn*
are the registers holding the operands.

Operation

QDSUB calculates $SAT(Rm - SAT(Rn * 2))$. It saturates the result to the signed range $-2^{31} \leq x \leq 2^{31}-1$. Saturation can occur on the doubling operation, on the subtraction, or on both. If saturation occurs on the doubling but not on the subtraction, the Q flag is set but the final result is unsaturated.

Note

All values are treated as two's complement signed integers by this instruction.

Register restrictions

You cannot use PC for any operand.

You can use SP in ARM instructions but this is deprecated in ARMv6T2 and above. You cannot use SP in Thumb instructions.

Q flag

If saturation occurs, this instruction sets the Q flag. To read the state of the Q flag, use an MRS instruction.

Architectures

This ARM instruction is available in ARMv6 and above, and E variants of ARMv5T.

This 32-bit Thumb instruction is available in ARMv6T2 and above. For the ARMv7-M architecture, it is only available in an ARMv7E-M implementation.

There is no 16-bit version of this instruction in Thumb.

Example

```
QDSUBLT r9, r0, r1
```

Related concepts

[2.17 The Q flag on page 2-52.](#)

Related references

[11.63 MRS \(PSR to general-purpose register\) on page 11-410.](#)

[11.8 Condition code suffixes on page 11-319.](#)

11.83 QSAX

Signed saturating parallel subtract and add halfwords with exchange.

Syntax

QSAX{*cond*} {*Rd*}, *Rn*, *Rm*

where:

cond
is an optional condition code.

Rd
is the destination register.

Rm, *Rn*
are the ARM registers holding the operands.

Operation

This instruction exchanges the two halfwords of the second operand, then performs a subtraction on the two top halfwords of the operands and an addition on the bottom two halfwords. It writes the results into the corresponding halfwords of the destination. It saturates the results to the signed range $-2^{15} \leq x \leq 2^{15} - 1$. The Q flag is not affected even if this operation saturates.

Register restrictions

You cannot use PC for any register.

You can use SP in ARM instructions but this is deprecated in ARMv6T2 and above. You cannot use SP in Thumb instructions.

Condition flags

This instruction does not affect the N, Z, C, V, Q, or GE flags.

Architectures

This ARM instruction is available in ARMv6 and above.

This 32-bit Thumb instruction is available in ARMv6T2 and above. For the ARMv7-M architecture, it is only available in an ARMv7E-M implementation.

There is no 16-bit version of this instruction in Thumb.

Related concepts

[2.17 The Q flag on page 2-52.](#)

Related references

[11.8 Condition code suffixes on page 11-319.](#)

11.84 QSUB

Signed saturating Subtract.

Syntax

QSUB{*cond*} {*Rd*}, *Rm*, *Rn*

where:

cond
is an optional condition code.

Rd
is the destination register.

Rm, *Rn*
are the registers holding the operands.

Operation

The QSUB instruction subtracts the value in *Rn* from the value in *Rm*. It saturates the result to the signed range $-2^{31} \leq x \leq 2^{31}-1$.

Note

All values are treated as two's complement signed integers by this instruction.

Register restrictions

You cannot use PC for any operand.

You can use SP in ARM instructions but this is deprecated in ARMv6T2 and above. You cannot use SP in Thumb instructions.

Q flag

If saturation occurs, this instruction sets the Q flag. To read the state of the Q flag, use an MRS instruction.

Architectures

This ARM instruction is available in ARMv6 and above, and E variants of ARMv5T.

This 32-bit Thumb instruction is available in ARMv6T2 and above. For the ARMv7-M architecture, it is only available in an ARMv7E-M implementation.

There is no 16-bit version of this instruction in Thumb.

Related concepts

[2.17 The Q flag on page 2-52.](#)

Related references

[11.63 MRS \(PSR to general-purpose register\) on page 11-410.](#)

[11.8 Condition code suffixes on page 11-319.](#)

11.85 QSUB8

Signed saturating parallel byte-wise subtraction.

Syntax

QSUB8{*cond*} {*Rd*}, *Rn*, *Rm*

where:

cond
is an optional condition code.

Rd
is the destination register.

Rm, *Rn*
are the ARM registers holding the operands.

Operation

This instruction subtracts each byte of the second operand from the corresponding byte of the first operand and writes the results into the corresponding bytes of the destination. It saturates the results to the signed range $-2^7 \leq x \leq 2^7 - 1$. The Q flag is not affected even if this operation saturates.

Register restrictions

You cannot use PC for any register.

You can use SP in ARM instructions but this is deprecated in ARMv6T2 and above. You cannot use SP in Thumb instructions.

Condition flags

This instruction does not affect the N, Z, C, V, Q, or GE flags.

Architectures

This ARM instruction is available in ARMv6 and above.

This 32-bit Thumb instruction is available in ARMv6T2 and above. For the ARMv7-M architecture, it is only available in an ARMv7E-M implementation.

There is no 16-bit version of this instruction in Thumb.

Related concepts

[2.17 The Q flag on page 2-52.](#)

Related references

[11.8 Condition code suffixes on page 11-319.](#)

11.86 QSUB16

Signed saturating parallel halfword-wise subtraction.

Syntax

QSUB16{*cond*} {*Rd*}, *Rn*, *Rm*

where:

cond
is an optional condition code.

Rd
is the destination register.

Rm, *Rn*
are the ARM registers holding the operands.

Operation

This instruction subtracts each halfword of the second operand from the corresponding halfword of the first operand and writes the results into the corresponding halfwords of the destination. It saturates the results to the signed range $-2^{15} \leq x \leq 2^{15} - 1$. The Q flag is not affected even if this operation saturates.

Register restrictions

You cannot use PC for any register.

You can use SP in ARM instructions but this is deprecated in ARMv6T2 and above. You cannot use SP in Thumb instructions.

Condition flags

This instruction does not affect the N, Z, C, V, Q, or GE flags.

Architectures

This ARM instruction is available in ARMv6 and above.

This 32-bit Thumb instruction is available in ARMv6T2 and above. For the ARMv7-M architecture, it is only available in an ARMv7E-M implementation.

There is no 16-bit version of this instruction in Thumb.

Related concepts

[2.17 The Q flag on page 2-52.](#)

Related references

[11.8 Condition code suffixes on page 11-319.](#)

11.87 RBIT

Reverse the bit order in a 32-bit word.

Syntax

RBIT{*cond*} *Rd*, *Rn*

where:

cond is an optional condition code.

Rd is the destination register.

Rn is the register holding the operand.

Register restrictions

You cannot use PC for any register.

You can use SP in ARM instructions but this is deprecated in ARMv6T2 and above. You cannot use SP in Thumb instructions.

Condition flags

This instruction does not change the flags.

Architectures

This ARM instruction is available in ARMv6T2 and above.

This 32-bit Thumb instruction is available in ARMv6T2 and above.

There is no 16-bit version of this instruction in Thumb.

Example

```
RBIT    r7, r8
```

Related references

[11.8 Condition code suffixes on page 11-319.](#)

11.88 REV

Reverse the byte order in a word.

Syntax

REV{*cond*} *Rd*, *Rn*

where:

cond
is an optional condition code.

Rd
is the destination register.

Rn
is the register holding the operand.

Usage

You can use this instruction to change endianness. REV converts 32-bit big-endian data into little-endian data or 32-bit little-endian data into big-endian data.

Register restrictions

You cannot use PC for any register.

You can use SP in ARM instructions but this is deprecated in ARMv6T2 and above. You cannot use SP in Thumb instructions.

Condition flags

This instruction does not change the flags.

16-bit instructions

The following form of this instruction is available in Thumb code, and is a 16-bit instruction:

REV *Rd*, *Rm*
Rd and *Rm* must both be Lo registers.

Architectures

This ARM instruction is available in ARMv6 and above.

This 32-bit Thumb instruction is available in ARMv6T2 and above.

This 16-bit Thumb instruction is available in ARMv6 and above.

Example

```
REV    r3, r7
```

Related references

[11.8 Condition code suffixes](#) on page 11-319.

11.89 REV16

Reverse the byte order in each halfword independently.

Syntax

REV16{*cond*} *Rd*, *Rn*

where:

cond

is an optional condition code.

Rd

is the destination register.

Rn

is the register holding the operand.

Usage

You can use this instruction to change endianness. REV16 converts 16-bit big-endian data into little-endian data or 16-bit little-endian data into big-endian data.

Register restrictions

You cannot use PC for any register.

You can use SP in ARM instructions but this is deprecated in ARMv6T2 and above. You cannot use SP in Thumb instructions.

Condition flags

This instruction does not change the flags.

16-bit instructions

The following form of this instruction is available in Thumb code, and is a 16-bit instruction:

REV16 *Rd*, *Rm*

Rd and *Rm* must both be Lo registers.

Architectures

This ARM instruction is available in ARMv6 and above.

This 32-bit Thumb instruction is available in ARMv6T2 and above.

This 16-bit Thumb instruction is available in ARMv6 and above.

Example

```
REV16 r0, r0
```

Related references

[11.8 Condition code suffixes](#) on page 11-319.

11.90 REVSH

Reverse the byte order in the bottom halfword, and sign extend to 32 bits.

Syntax

REVSH{*cond*} *Rd*, *Rn*

where:

cond

is an optional condition code.

Rd

is the destination register.

Rn

is the register holding the operand.

Usage

You can use this instruction to change endianness. REVSH converts either:

- 16-bit signed big-endian data into 32-bit signed little-endian data.
- 16-bit signed little-endian data into 32-bit signed big-endian data.

Register restrictions

You cannot use PC for any register.

You can use SP in ARM instructions but this is deprecated in ARMv6T2 and above. You cannot use SP in Thumb instructions.

Condition flags

This instruction does not change the flags.

16-bit instructions

The following form of this instruction is available in Thumb code, and is a 16-bit instruction:

REVSH *Rd*, *Rm*

Rd and *Rm* must both be Lo registers.

Architectures

This ARM instruction is available in ARMv6 and above.

This 32-bit Thumb instruction is available in ARMv6T2 and above.

This 16-bit Thumb instruction is available in ARMv6 and above.

Example

```
REVSH r0, r5 ; Reverse Signed Halfword
```

Related references

[11.8 Condition code suffixes on page 11-319.](#)

11.91 RFE

Return From Exception.

Syntax

RFE{*addr_mode*}{*cond*} *Rn*{!}

where:

addr_mode

is any one of the following:

IA

Increment address After each transfer (Full Descending stack)

IB

Increment address Before each transfer (ARM only)

DA

Decrement address After each transfer (ARM only)

DB

Decrement address Before each transfer.

If *addr_mode* is omitted, it defaults to Increment After.

cond

is an optional condition code.

————— **Note** —————

cond is permitted only in Thumb code, using a preceding IT instruction. This is an unconditional instruction in ARM code.

Rn

specifies the base register. *Rn* must not be PC.

!

is an optional suffix. If ! is present, the final address is written back into *Rn*.

Usage

You can use RFE to return from an exception if you previously saved the return state using the SRS instruction. *Rn* is usually the SP where the return state information was saved.

Operation

Loads the PC and the CPSR from the address contained in *Rn*, and the following address. Optionally updates *Rn*.

Notes

RFE writes an address to the PC. The alignment of this address must be correct for the instruction set in use after the exception return:

- For a return to ARM, the address written to the PC must be word-aligned.
- For a return to Thumb, the address written to the PC must be halfword-aligned.
- For a return to Jazelle, there are no alignment restrictions on the address written to the PC.

No special precautions are required in software to follow these rules, if you use the instruction to return after a valid exception entry mechanism.

Where addresses are not word-aligned, RFE ignores the least significant two bits of *Rn*.

The time order of the accesses to individual words of memory generated by RFE is not architecturally defined. Do not use this instruction on memory-mapped I/O locations where access order matters.

Do not use RFE in unprivileged software execution.

Architectures

This ARM instruction is available in ARMv6 and above.

This 32-bit Thumb instruction is available in ARMv6T2 and above, except the ARMv7-M architecture.

There is no 16-bit version of this instruction.

Example

```
RFE sp!
```

Related concepts

[2.4 Processor modes, and privileged and unprivileged software execution](#) on page 2-38.

Related references

[11.128 SRS](#) on page 11-492.

[11.8 Condition code suffixes](#) on page 11-319.

11.92 ROR

Rotate Right. This instruction is a preferred synonym for MOV instructions with shifted register operands.

Syntax

ROR{S}{cond} Rd, Rm, Rs

ROR{S}{cond} Rd, Rm, #sh

where:

S

is an optional suffix. If S is specified, the condition flags are updated on the result of the operation.

Rd

is the destination register.

Rm

is the register holding the first operand. This operand is shifted right.

Rs

is a register holding a shift value to apply to the value in Rm. Only the least significant byte is used.

sh

is a constant shift. The range of values is 1-31.

Operation

ROR provides the value of the contents of a register rotated by a value. The bits that are rotated off the right end are inserted into the vacated bit positions on the left.

Restrictions in Thumb code

Thumb instructions must not use PC or SP.

Use of SP and PC in ARM instructions

You can use SP in these ARM instructions but this is deprecated in ARMv6T2 and above.

You cannot use PC in instructions with the ROR{S}{cond} Rd, Rm, Rs syntax. You can use PC for Rd and Rm in the other syntax, but this is deprecated in ARMv6T2 and above.

If you use PC as Rm, the value used is the address of the instruction plus 8.

If you use PC as Rd:

- Execution branches to the address corresponding to the result.
- If you use the S suffix, the SPSR of the current mode is copied to the CPSR. You can use this to return from exceptions.

————— **Note** —————

The ARM instruction RORS{cond} pc, Rm, #sh always disassembles to the preferred form MOVS{cond} pc, Rm{, shift}.

————— **Caution** —————

Do not use the S suffix when using PC as Rd in User mode or System mode. The assembler cannot warn you about this because it has no information about what the processor mode is likely to be at execution time.

You cannot use PC for Rd or any operand in this instruction if it has a register-controlled shift.

Condition flags

If S is specified, the instruction updates the N and Z flags according to the result.

The C flag is unaffected if the shift value is 0. Otherwise, the C flag is updated to the last bit shifted out.

16-bit instructions

The following forms of this instruction are available in Thumb code, and are 16-bit instructions:

RORS *Rd*, *Rd*, *Rs*

Rd and *Rs* must both be Lo registers. This form can only be used outside an IT block.

ROR{*cond*} *Rd*, *Rd*, *Rs*

Rd and *Rs* must both be Lo registers. This form can only be used inside an IT block.

Architectures

This ARM instruction is available in all architectures.

This 32-bit Thumb instruction is available in ARMv6T2 and above.

This 16-bit Thumb instruction is available in ARMv4T and above.

Example

```
ROR    r4, r5, r6
```

Related references

[11.57 MOV](#) on page 11-403.

[11.8 Condition code suffixes](#) on page 11-319.

11.93 RRX

Rotate Right with Extend. This instruction is a preferred synonym for MOV instructions with shifted register operands.

Syntax

`RRX{S}{cond} Rd, Rm`

where:

S

is an optional suffix. If S is specified, the condition flags are updated on the result of the operation.

Rd

is the destination register.

Rm

is the register holding the first operand. This operand is shifted right.

Operation

RRX provides the value of the contents of a register shifted right one bit. The old carry flag is shifted into bit[31]. If the S suffix is present, the old bit[0] is placed in the carry flag.

Restrictions in Thumb code

Thumb instructions must not use PC or SP.

Use of SP and PC in ARM instructions

You can use SP in this ARM instruction but this is deprecated in ARMv6T2 and above.

If you use PC as *Rm*, the value used is the address of the instruction plus 8.

If you use PC as *Rd*:

- Execution branches to the address corresponding to the result.
- If you use the S suffix, the SPSR of the current mode is copied to the CPSR. You can use this to return from exceptions.

————— **Note** —————

The ARM instruction `RRXS{cond} pc, Rm` always disassembles to the preferred form `MOVS{cond} pc, Rm{, shift}`.

————— **Caution** —————

Do not use the S suffix when using PC as *Rd* in User mode or System mode. The assembler cannot warn you about this because it has no information about what the processor mode is likely to be at execution time.

You cannot use PC for *Rd* or any operand in this instruction if it has a register-controlled shift.

Condition flags

If S is specified, the instruction updates the N and Z flags according to the result.

The C flag is unaffected if the shift value is 0. Otherwise, the C flag is updated to the last bit shifted out.

Architectures

This ARM instruction is available in all architectures.

This 32-bit Thumb instruction is available in ARMv6T2 and above.

There is no 16-bit RRX instruction in Thumb.

Related references

[11.57 MOV](#) on page 11-403.

[11.8 Condition code suffixes](#) on page 11-319.

11.94 RSB

Reverse Subtract without carry.

Syntax

RSB{S}{*cond*} {*Rd*}, *Rn*, *Operand2*

where:

S

is an optional suffix. If S is specified, the condition flags are updated on the result of the operation.

cond

is an optional condition code.

Rd

is the destination register.

Rn

is the register holding the first operand.

Operand2

is a flexible second operand.

Operation

The RSB instruction subtracts the value in *Rn* from the value of *Operand2*. This is useful because of the wide range of options for *Operand2*.

In certain circumstances, the assembler can substitute one instruction for another. Be aware of this when reading disassembly listings.

Use of PC and SP in Thumb instructions

You cannot use PC (R15) for *Rd* or any operand.

You cannot use SP (R13) for *Rd* or any operand.

Use of PC and SP in ARM instructions

You cannot use PC for *Rd* or any operand in an RSB instruction that has a register-controlled shift.

Use of PC for any operand, in instructions without register-controlled shift, is deprecated.

If you use PC (R15) as *Rn* or *Rm*, the value used is the address of the instruction plus 8.

If you use PC as *Rd*:

- Execution branches to the address corresponding to the result.
- If you use the S suffix, see the SUBS *pc, 1r* instruction.

Use of SP in RSB ARM instructions is deprecated.

Note

The deprecation of SP and PC in ARM instructions is only in ARMv6T2 and above.

Condition flags

If S is specified, the RSB instruction updates the N, Z, C and V flags according to the result.

16-bit instructions

The following forms of this instruction are available in Thumb code, and are 16-bit instructions:

RSBS *Rd*, *Rn*, #0

Rd and *Rn* must both be Lo registers. This form can only be used outside an IT block.

RSB{*cond*} *Rd*, *Rn*, #0

Rd and *Rn* must both be Lo registers. This form can only be used inside an IT block.

Example

```
RSB    r4, r4, #1280    ; subtracts contents of R4 from 1280
```

Related references

[11.3 Flexible second operand \(Operand2\)](#) on page 11-312.

[11.8 Condition code suffixes](#) on page 11-319.

Related information

[Handling Processor Exceptions.](#)

11.95 RSC

Reverse Subtract with Carry.

Syntax

RSC{S}{*cond*} {*Rd*}, *Rn*, *Operand2*

where:

S

is an optional suffix. If S is specified, the condition flags are updated on the result of the operation.

cond

is an optional condition code.

Rd

is the destination register.

Rn

is the register holding the first operand.

Operand2

is a flexible second operand.

Usage

The RSC instruction subtracts the value in *Rn* from the value of *Operand2*. If the carry flag is clear, the result is reduced by one.

You can use RSC to synthesize multiword arithmetic.

In certain circumstances, the assembler can substitute one instruction for another. Be aware of this when reading disassembly listings.

RSC is not available in Thumb code.

Use of PC and SP

You cannot use PC for *Rd* or any operand in an RSC instruction that has a register-controlled shift.

Use of PC for any operand in RSC instructions without register-controlled shift, is deprecated.

If you use PC (R15) as *Rn* or *Rm*, the value used is the address of the instruction plus 8.

If you use PC as *Rd*:

- Execution branches to the address corresponding to the result.
- If you use the S suffix, see the SUBS *pc*, *l*r instruction.

Use of SP in RSC instructions is deprecated.

————— **Note** —————

The deprecation of SP and PC is only in ARMv6T2 and above.

Condition flags

If S is specified, the RSC instruction updates the N, Z, C and V flags according to the result.

Correct example

```
RSCSLE r0,r5,r0,LSL r4 ; conditional, flags set
```

Incorrect example

```
RSCSLE r0,pc,r0,LSL r4 ; PC not permitted with register  
                        ; controlled shift
```

Related references

[11.3 Flexible second operand \(Operand2\) on page 11-312.](#)

[11.8 Condition code suffixes on page 11-319.](#)

Related information

[Handling Processor Exceptions.](#)

11.96 SADD8

Signed parallel byte-wise addition.

Syntax

SADD8{*cond*} {*Rd*}, *Rn*, *Rm*

where:

cond

is an optional condition code.

Rd

is the destination register.

Rm, *Rn*

are the ARM registers holding the operands.

Operation

This instruction performs four signed integer additions on the corresponding bytes of the operands and writes the results into the corresponding bytes of the destination. The results are modulo 2^8 . It sets the APSR GE flags.

Register restrictions

You cannot use PC for any register.

You can use SP in ARM instructions but this is deprecated in ARMv6T2 and above. You cannot use SP in Thumb instructions.

GE flags

This instruction does not affect the N, Z, C, V, or Q flags.

It sets the GE flags in the APSR as follows:

GE[0]

for bits[7:0] of the result.

GE[1]

for bits[15:8] of the result.

GE[2]

for bits[23:16] of the result.

GE[3]

for bits[31:24] of the result.

It sets a GE flag to 1 to indicate that the corresponding result is greater than or equal to zero. This is equivalent to an ADDS instruction setting the N and V condition flags to the same value, so that the GE condition passes.

You can use these flags to control a following SEL instruction.

Architectures

This ARM instruction is available in ARMv6 and above.

This 32-bit Thumb instruction is available in ARMv6T2 and above. For the ARMv7-M architecture, it is only available in an ARMv7E-M implementation.

There is no 16-bit version of this instruction in Thumb.

Related references

[11.102 SEL on page 11-464.](#)

[11.8 Condition code suffixes on page 11-319.](#)

11.97 SADD16

Signed parallel halfword-wise addition.

Syntax

SADD16{*cond*} {*Rd*}, *Rn*, *Rm*

where:

cond

is an optional condition code.

Rd

is the destination register.

Rm, *Rn*

are the ARM registers holding the operands.

Operation

This instruction performs two signed integer additions on the corresponding halfwords of the operands and writes the results into the corresponding halfwords of the destination. The results are modulo 2^{16} . It sets the APSR GE flags.

Register restrictions

You cannot use PC for any register.

You can use SP in ARM instructions but this is deprecated in ARMv6T2 and above. You cannot use SP in Thumb instructions.

GE flags

This instruction does not affect the N, Z, C, V, or Q flags.

It sets the GE flags in the APSR as follows:

GE[1:0]

for bits[15:0] of the result.

GE[3:2]

for bits[31:16] of the result.

It sets a pair of GE flags to 1 to indicate that the corresponding result is greater than or equal to zero. This is equivalent to an ADDS instruction setting the N and V condition flags to the same value, so that the GE condition passes.

You can use these flags to control a following SEL instruction.

————— **Note** —————

GE[1:0] are set or cleared together, and GE[3:2] are set or cleared together.

Architectures

This ARM instruction is available in ARMv6 and above.

This 32-bit Thumb instruction is available in ARMv6T2 and above. For the ARMv7-M architecture, it is only available in an ARMv7E-M implementation.

There is no 16-bit version of this instruction in Thumb.

Related references

[11.102 SEL on page 11-464.](#)

[11.8 Condition code suffixes on page 11-319.](#)

11.98 SASX

Signed parallel add and subtract halfwords with exchange.

Syntax

$SASX\{cond\} \{Rd\}, Rn, Rm$

where:

$cond$
is an optional condition code.

Rd
is the destination register.

Rm, Rn
are the ARM registers holding the operands.

Operation

This instruction exchanges the two halfwords of the second operand, then performs an addition on the two top halfwords of the operands and a subtraction on the bottom two halfwords. It writes the results into the corresponding halfwords of the destination. The results are modulo 2^{16} . It sets the APSR GE flags.

Register restrictions

You cannot use PC for any register.

You can use SP in ARM instructions but this is deprecated in ARMv6T2 and above. You cannot use SP in Thumb instructions.

GE flags

This instruction does not affect the N, Z, C, V, or Q flags.

It sets the GE flags in the APSR as follows:

$GE[1:0]$
for bits[15:0] of the result.

$GE[3:2]$
for bits[31:16] of the result.

It sets a pair of GE flags to 1 to indicate that the corresponding result is greater than or equal to zero. This is equivalent to an ADDS or SUBS instruction setting the N and V condition flags to the same value, so that the GE condition passes.

You can use these flags to control a following SEL instruction.

————— **Note** —————

$GE[1:0]$ are set or cleared together, and $GE[3:2]$ are set or cleared together.

Architectures

This ARM instruction is available in ARMv6 and above.

This 32-bit Thumb instruction is available in ARMv6T2 and above. For the ARMv7-M architecture, it is only available in an ARMv7E-M implementation.

There is no 16-bit version of this instruction in Thumb.

Related references

[11.102 SEL](#) on page 11-464.

[11.8 Condition code suffixes](#) on page 11-319.

11.99 SBC

Subtract with Carry.

Syntax

SBC{S}{*cond*} {*Rd*}, *Rn*, *Operand2*

where:

S

is an optional suffix. If S is specified, the condition flags are updated on the result of the operation.

cond

is an optional condition code.

Rd

is the destination register.

Rn

is the register holding the first operand.

Operand2

is a flexible second operand.

Usage

The SBC (Subtract with Carry) instruction subtracts the value of *Operand2* from the value in *Rn*. If the carry flag is clear, the result is reduced by one.

You can use SBC to synthesize multiword arithmetic.

In certain circumstances, the assembler can substitute one instruction for another. Be aware of this when reading disassembly listings.

Use of PC and SP in Thumb instructions

You cannot use PC (R15) for *Rd*, or any operand.

You cannot use SP (R13) for *Rd*, or any operand.

Use of PC and SP in ARM instructions

You cannot use PC for *Rd* or any operand in an SBC instruction that has a register-controlled shift.

Use of PC for any operand in instructions without register-controlled shift, is deprecated.

If you use PC (R15) as *Rn* or *Rm*, the value used is the address of the instruction plus 8.

If you use PC as *Rd*:

- Execution branches to the address corresponding to the result.
- If you use the S suffix, see the SUBS *pc*, *l*r instruction.

Use of SP in SBC ARM instructions is deprecated.

Note

The deprecation of SP and PC in ARM instructions is only in ARMv6T2 and above.

Condition flags

If S is specified, the SBC instruction updates the N, Z, C and V flags according to the result.

16-bit instructions

The following forms of this instruction are available in Thumb code, and are 16-bit instructions:

SBCS *Rd*, *Rd*, *Rm*

Rd and *Rm* must both be Lo registers. This form can only be used outside an IT block.

SBC{*cond*} *Rd*, *Rd*, *Rm*

Rd and *Rm* must both be Lo registers. This form can only be used inside an IT block.

Multiword arithmetic examples

These instructions subtract one 96-bit integer contained in R9, R10, and R11 from another 96-bit integer contained in R6, R7, and R8, and place the result in R3, R4, and R5:

```
SUBS    r3, r6, r9
SBCS   r4, r7, r10
SBC    r5, r8, r11
```

For clarity, the above examples use consecutive registers for multiword values. There is no requirement to do this. The following, for example, is perfectly valid:

```
SUBS    r6, r6, r9
SBCS   r9, r2, r1
SBC    r2, r8, r11
```

Related references

[11.3 Flexible second operand \(*Operand2*\) on page 11-312.](#)

[11.8 Condition code suffixes on page 11-319.](#)

Related information

[Handling Processor Exceptions.](#)

11.100 SBFX

Signed Bit Field Extract.

Syntax

`SBFX{cond} Rd, Rn, #Lsb, #width`

where:

cond

is an optional condition code.

Rd

is the destination register.

Rn

is the source register.

Lsb

is the bit number of the least significant bit in the bitfield, in the range 0 to 31.

width

is the width of the bitfield, in the range 1 to (32-*Lsb*).

Operation

Copies adjacent bits from one register into the least significant bits of a second register, and sign extends to 32 bits.

Register restrictions

You cannot use PC for any register.

You can use SP in the ARM instruction but this is deprecated in ARMv6T2 and above. You cannot use SP in the Thumb instruction.

Condition flags

This instruction does not alter any flags.

Architectures

This ARM instruction is available in ARMv6T2 and above.

This 32-bit Thumb instruction is available in ARMv6T2 and above.

There is no 16-bit version of this instruction in Thumb.

Related references

[11.8 Condition code suffixes on page 11-319.](#)

11.101 SDIV

Signed Divide.

Syntax

`SDIV{cond} {Rd}, Rn, Rm`

where:

cond

is an optional condition code.

Rd

is the destination register.

Rn

is the register holding the value to be divided.

Rm

is a register holding the divisor.

Register restrictions

PC or SP cannot be used for *Rd*, *Rn* or *Rm*.

Architectures

This 32-bit Thumb instruction is available in ARMv7-R and ARMv7-M.

This ARM instruction is optional in ARMv7-R.

This ARM and 32-bit Thumb instruction is available in ARMv7-A if Virtualization Extensions are implemented, and optional if not.

There is no 16-bit Thumb SDIV instruction.

Related references

[11.8 Condition code suffixes](#) on page 11-319.

11.102 SEL

Select bytes from each operand according to the state of the APSR GE flags.

Syntax

```
SEL{cond} {Rd}, Rn, Rm
```

where:

cond

is an optional condition code.

Rd

is the destination register.

Rn

is the register holding the first operand.

Rm

is the register holding the second operand.

Operation

The SEL instruction selects bytes from *Rn* or *Rm* according to the APSR GE flags:

- If GE[0] is set, Rd[7:0] come from Rn[7:0], otherwise from Rm[7:0].
- If GE[1] is set, Rd[15:8] come from Rn[15:8], otherwise from Rm[15:8].
- If GE[2] is set, Rd[23:16] come from Rn[23:16], otherwise from Rm[23:16].
- If GE[3] is set, Rd[31:24] come from Rn[31:24], otherwise from Rm[31:24].

Usage

Use the SEL instruction after one of the signed parallel instructions. You can use this to select maximum or minimum values in multiple byte or halfword data.

Register restrictions

You cannot use PC for any register.

You can use SP in ARM instructions but this is deprecated in ARMv6T2 and above. You cannot use SP in Thumb instructions.

Condition flags

This instruction does not change the flags.

Architectures

This ARM instruction is available in ARMv6 and above.

This 32-bit Thumb instruction is available in ARMv6T2 and above. For the ARMv7-M architecture, it is only available in an ARMv7E-M implementation.

There is no 16-bit version of this instruction in Thumb.

Examples

```
SEL    r0, r4, r5
SELLT r4, r0, r4
```

The following instruction sequence sets each byte in R4 equal to the unsigned minimum of the corresponding bytes of R1 and R2:

```
USUB8 r4, r1, r2
SEL    r4, r2, r1
```

Related concepts

2.16 Application Program Status Register on page 2-51.

Related references

11.8 Condition code suffixes on page 11-319.

11.103 SETEND

Set the endianness bit in the CPSR, without affecting any other bits in the CPSR.

Syntax

SETEND *specifier*

where:

specifier

is one of:

BE

Big-endian.

LE

Little-endian.

Usage

Use SETEND to access data of different endianness, for example, to access several big-endian DMA-formatted data fields from an otherwise little-endian application.

SETEND cannot be conditional, and is not permitted in an IT block.

Architectures

This ARM instruction is available in ARMv6 and above.

This 16-bit Thumb instruction is available in T variants of ARMv6 and above, except the ARMv6-M and ARMv7-M architectures.

There is no 32-bit version of this instruction in Thumb.

Example

```
SETEND BE      ; Set the CPSR E bit for big-endian accesses
LDR    r0, [r2, #header]
LDR    r1, [r2, #CRC32]
SETEND le      ; Set the CPSR E bit for little-endian accesses
                ; for the rest of the application
```

11.104 SEV

Set Event.

Syntax

SEV{*cond*}

where:

cond

is an optional condition code.

Operation

This is a hint instruction. It is optional whether it is implemented or not. If it is not implemented, it executes as a NOP. The assembler produces a diagnostic message if the instruction executes as a NOP on the target.

SEV executes as a NOP instruction in ARMv6T2.

SEV causes an event to be signaled to all cores within a multiprocessor system. If SEV is implemented, WFE must also be implemented.

Architectures

This ARM instruction is available in ARMv6K and above.

This 32-bit Thumb instruction is available in ARMv6T2 and above.

This 16-bit Thumb instruction is available in ARMv6T2 and above.

Related references

[11.70 NOP on page 11-421.](#)

[11.8 Condition code suffixes on page 11-319.](#)

11.105 SHADD8

Signed halving parallel byte-wise addition.

Syntax

SHADD8{*cond*} {*Rd*}, *Rn*, *Rm*

where:

cond
is an optional condition code.

Rd
is the destination register.

Rm, *Rn*
are the ARM registers holding the operands.

Operation

This instruction performs four signed integer additions on the corresponding bytes of the operands, halves the results, and writes the results into the corresponding bytes of the destination. This cannot cause overflow.

Register restrictions

You cannot use PC for any register.

You can use SP in ARM instructions but this is deprecated in ARMv6T2 and above. You cannot use SP in Thumb instructions.

Condition flags

This instruction does not affect the N, Z, C, V, Q, or GE flags.

Architectures

This ARM instruction is available in ARMv6 and above.

This 32-bit Thumb instruction is available in ARMv6T2 and above. For the ARMv7-M architecture, it is only available in an ARMv7E-M implementation.

There is no 16-bit version of this instruction in Thumb.

Related references

[11.8 Condition code suffixes on page 11-319.](#)

11.106 SHADD16

Signed halving parallel halfword-wise addition.

Syntax

SHADD16{*cond*} {*Rd*}, *Rn*, *Rm*

where:

cond
is an optional condition code.

Rd
is the destination register.

Rm, *Rn*
are the ARM registers holding the operands.

Operation

This instruction performs two signed integer additions on the corresponding halfwords of the operands, halves the results, and writes the results into the corresponding halfwords of the destination. This cannot cause overflow.

Register restrictions

You cannot use PC for any register.

You can use SP in ARM instructions but this is deprecated in ARMv6T2 and above. You cannot use SP in Thumb instructions.

Condition flags

This instruction does not affect the N, Z, C, V, Q, or GE flags.

Architectures

This ARM instruction is available in ARMv6 and above.

This 32-bit Thumb instruction is available in ARMv6T2 and above. For the ARMv7-M architecture, it is only available in an ARMv7E-M implementation.

There is no 16-bit version of this instruction in Thumb.

Related references

[11.8 Condition code suffixes on page 11-319.](#)

11.107 SHASX

Signed halving parallel add and subtract halfwords with exchange.

Syntax

SHASX{*cond*} {*Rd*}, *Rn*, *Rm*

where:

cond
is an optional condition code.

Rd
is the destination register.

Rm, *Rn*
are the ARM registers holding the operands.

Operation

This instruction exchanges the two halfwords of the second operand, then performs an addition on the two top halfwords of the operands and a subtraction on the bottom two halfwords. It halves the results and writes them into the corresponding halfwords of the destination. This cannot cause overflow.

Register restrictions

You cannot use PC for any register.

You can use SP in ARM instructions but this is deprecated in ARMv6T2 and above. You cannot use SP in Thumb instructions.

Condition flags

This instruction does not affect the N, Z, C, V, Q, or GE flags.

Architectures

This ARM instruction is available in ARMv6 and above.

This 32-bit Thumb instruction is available in ARMv6T2 and above. For the ARMv7-M architecture, it is only available in an ARMv7E-M implementation.

There is no 16-bit version of this instruction in Thumb.

Related references

[11.8 Condition code suffixes on page 11-319.](#)

11.108 SHSAX

Signed halving parallel subtract and add halfwords with exchange.

Syntax

SHSAX{*cond*} {*Rd*}, *Rn*, *Rm*

where:

cond
is an optional condition code.

Rd
is the destination register.

Rm, *Rn*
are the ARM registers holding the operands.

Operation

This instruction exchanges the two halfwords of the second operand, then performs a subtraction on the two top halfwords of the operands and an addition on the bottom two halfwords. It halves the results and writes them into the corresponding halfwords of the destination. This cannot cause overflow.

Register restrictions

You cannot use PC for any register.

You can use SP in ARM instructions but this is deprecated in ARMv6T2 and above. You cannot use SP in Thumb instructions.

Condition flags

This instruction does not affect the N, Z, C, V, Q, or GE flags.

Architectures

This ARM instruction is available in ARMv6 and above.

This 32-bit Thumb instruction is available in ARMv6T2 and above. For the ARMv7-M architecture, it is only available in an ARMv7E-M implementation.

There is no 16-bit version of this instruction in Thumb.

Related references

[11.8 Condition code suffixes on page 11-319.](#)

11.109 SHSUB8

Signed halving parallel byte-wise subtraction.

Syntax

`SHSUB8{cond} {Rd}, Rn, Rm`

where:

cond
is an optional condition code.

Rd
is the destination register.

Rm, Rn
are the ARM registers holding the operands.

Operation

This instruction subtracts each byte of the second operand from the corresponding byte of the first operand, halves the results, and writes the results into the corresponding bytes of the destination. This cannot cause overflow.

Register restrictions

You cannot use PC for any register.

You can use SP in ARM instructions but this is deprecated in ARMv6T2 and above. You cannot use SP in Thumb instructions.

Condition flags

This instruction does not affect the N, Z, C, V, Q, or GE flags.

Architectures

This ARM instruction is available in ARMv6 and above.

This 32-bit Thumb instruction is available in ARMv6T2 and above. For the ARMv7-M architecture, it is only available in an ARMv7E-M implementation.

There is no 16-bit version of this instruction in Thumb.

Related references

[11.8 Condition code suffixes on page 11-319.](#)

11.110 SHSUB16

Signed halving parallel halfword-wise subtraction.

Syntax

SHSUB16{*cond*} {*Rd*}, *Rn*, *Rm*

where:

cond
is an optional condition code.

Rd
is the destination register.

Rm, *Rn*
are the ARM registers holding the operands.

Operation

This instruction subtracts each halfword of the second operand from the corresponding halfword of the first operand, halves the results, and writes the results into the corresponding halfwords of the destination. This cannot cause overflow.

Register restrictions

You cannot use PC for any register.

You can use SP in ARM instructions but this is deprecated in ARMv6T2 and above. You cannot use SP in Thumb instructions.

Condition flags

This instruction does not affect the N, Z, C, V, Q, or GE flags.

Architectures

This ARM instruction is available in ARMv6 and above.

This 32-bit Thumb instruction is available in ARMv6T2 and above. For the ARMv7-M architecture, it is only available in an ARMv7E-M implementation.

There is no 16-bit version of this instruction in Thumb.

Related references

[11.8 Condition code suffixes on page 11-319.](#)

11.111 SMC

Secure Monitor Call.

Syntax

`SMC{cond} #imm4`

where:

cond

is an optional condition code.

imm4

is a 4-bit immediate value. This is ignored by the ARM processor, but can be used by the SMC exception handler to determine what service is being requested.

Note

SMC was called SMI in earlier versions of the ARM assembly language. SMI instructions disassemble to SMC, with a comment to say that this was formerly SMI.

Architectures

This ARM instruction is available in implementations of ARMv6 and above, if they have the Security Extensions.

This 32-bit Thumb instruction is available in implementations of ARMv6T2 and above, if they have the Security Extensions.

There is no 16-bit version of this instruction in Thumb.

Related references

[11.8 Condition code suffixes on page 11-319.](#)

Related information

[ARM Architecture Reference Manual.](#)

11.112 SMLAxy

Signed Multiply Accumulate, with 16-bit operands and a 32-bit result and accumulator.

Syntax

SMLA<x><y>{cond} Rd, Rn, Rm, Ra

where:

<x>

is either B or T. B means use the bottom half (bits [15:0]) of *Rn*, T means use the top half (bits [31:16]) of *Rn*.

<y>

is either B or T. B means use the bottom half (bits [15:0]) of *Rm*, T means use the top half (bits [31:16]) of *Rm*.

cond

is an optional condition code.

Rd

is the destination register.

Rn, Rm

are the registers holding the values to be multiplied.

Ra

is the register holding the value to be added.

Operation

SMLAxy multiplies the 16-bit signed integers from the selected halves of *Rn* and *Rm*, adds the 32-bit result to the 32-bit value in *Ra*, and places the result in *Rd*.

Register restrictions

You cannot use PC for any register.

You can use SP in ARM instructions but this is deprecated in ARMv6T2 and above. You cannot use SP in Thumb instructions.

Condition flags

This instruction does not affect the N, Z, C, or V flags.

If overflow occurs in the accumulation, SMLAxy sets the Q flag. To read the state of the Q flag, use an MRS instruction.

Note

SMLAxy never clears the Q flag. To clear the Q flag, use an MSR instruction.

Architectures

This ARM instruction is available in ARMv6 and above, and E variants of ARMv5T.

This 32-bit Thumb instruction is available in ARMv6T2 and above. For the ARMv7-M architecture, it is only available in an ARMv7E-M implementation.

There is no 16-bit version of this instruction in Thumb.

Examples

SMLABBNE	r0, r2, r1, r10
SMLABT	r0, r0, r3, r5

Related references

11.63 MRS (PSR to general-purpose register) on page 11-410.

11.66 MSR (general-purpose register to PSR) on page 11-414.

11.8 Condition code suffixes on page 11-319.

11.113 SMLAD

Dual 16-bit Signed Multiply with Addition of products and 32-bit accumulation.

Syntax

SMLAD{X}{*cond*} *Rd*, *Rn*, *Rm*, *Ra*

where:

cond

is an optional condition code.

X

is an optional parameter. If X is present, the most and least significant halfwords of the second operand are exchanged before the multiplications occur.

Rd

is the destination register.

Rn, *Rm*

are the registers holding the operands.

Ra

is the register holding the accumulate operand.

Operation

SMLAD multiplies the bottom halfword of *Rn* with the bottom halfword of *Rm*, and the top halfword of *Rn* with the top halfword of *Rm*. It then adds both products to the value in *Ra* and stores the sum to *Rd*.

Register restrictions

You cannot use PC for any register.

You can use SP in ARM instructions but this is deprecated in ARMv6T2 and above. You cannot use SP in Thumb instructions.

Condition flags

This instruction does not change the flags.

Architectures

This ARM instruction is available in ARMv6 and above.

This 32-bit Thumb instruction is available in ARMv6T2 and above. For the ARMv7-M architecture, it is only available in an ARMv7E-M implementation.

There is no 16-bit version of this instruction in Thumb.

Example

```
SMLADLT    r1, r2, r4, r1
```

Related references

[11.8 Condition code suffixes on page 11-319.](#)

11.114 SMLAL

Signed Long Multiply, with optional Accumulate, with 32-bit operands, and 64-bit result and accumulator.

Syntax

SMLAL{S}{cond} RdLo, RdHi, Rn, Rm

where:

S

is an optional suffix available in ARM state only. If S is specified, the condition flags are updated on the result of the operation.

cond

is an optional condition code.

RdLo, *RdHi*

are the destination registers. They also hold the accumulating value. *RdLo* and *RdHi* must be different registers

Rn, *Rm*

are ARM registers holding the operands.

Operation

The SMLAL instruction interprets the values from *Rn* and *Rm* as two's complement signed integers. It multiplies these integers, and adds the 64-bit result to the 64-bit signed integer contained in *RdHi* and *RdLo*.

Register restrictions

Rn must be different from *RdLo* and *RdHi* in architectures before ARMv6.

You cannot use PC for any register.

You can use SP in ARM instructions but this is deprecated in ARMv6T2 and above. You cannot use SP in Thumb instructions.

Condition flags

If S is specified, this instruction:

- Updates the N and Z flags according to the result.
- Does not affect the C or V flags.

Architectures

This ARM instruction is available in all versions of the ARM architecture.

This 32-bit Thumb instruction is available in ARMv6T2 and above.

There is no 16-bit version of this instruction in Thumb.

Related references

[11.8 Condition code suffixes on page 11-319.](#)

11.115 SMLALD

Dual 16-bit Signed Multiply with Addition of products and 64-bit Accumulation.

Syntax

SMLALD{X}{*cond*} *RdLo*, *RdHi*, *Rn*, *Rm*

where:

X

is an optional parameter. If X is present, the most and least significant halfwords of the second operand are exchanged before the multiplications occur.

cond

is an optional condition code.

RdLo*, *RdHi

are the destination registers for the 64-bit result. They also hold the 64-bit accumulate operand. *RdHi* and *RdLo* must be different registers.

Rn*, *Rm

are the registers holding the operands.

Operation

SMLALD multiplies the bottom halfword of *Rn* with the bottom halfword of *Rm*, and the top halfword of *Rn* with the top halfword of *Rm*. It then adds both products to the value in *RdLo*, *RdHi* and stores the sum to *RdLo*, *RdHi*.

Register restrictions

You cannot use PC for any register.

You can use SP in ARM instructions but this is deprecated in ARMv6T2 and above. You cannot use SP in Thumb instructions.

Condition flags

This instruction does not change the flags.

Architectures

This ARM instruction is available in ARMv6 and above.

This 32-bit Thumb instruction is available in ARMv6T2 and above. For the ARMv7-M architecture, it is only available in an ARMv7E-M implementation.

There is no 16-bit version of this instruction in Thumb.

Example

```
SMLALD    r10, r11, r5, r1
```

Related references

[11.8 Condition code suffixes on page 11-319.](#)

11.116 SMLALxy

Signed Multiply-Accumulate with 16-bit operands and a 64-bit accumulator.

Syntax

SMLAL<x><y>{cond} RdLo, RdHi, Rn, Rm

where:

<x>

is either B or T. B means use the bottom half (bits [15:0]) of *Rn*, T means use the top half (bits [31:16]) of *Rn*.

<y>

is either B or T. B means use the bottom half (bits [15:0]) of *Rm*, T means use the top half (bits [31:16]) of *Rm*.

cond

is an optional condition code.

RdLo, RdHi

are the destination registers. They also hold the accumulate value. *RdHi* and *RdLo* must be different registers.

Rn, Rm

are the registers holding the values to be multiplied.

Operation

SMLALxy multiplies the signed integer from the selected half of *Rm* by the signed integer from the selected half of *Rn*, and adds the 32-bit result to the 64-bit value in *RdHi* and *RdLo*.

Register restrictions

You cannot use PC for any register.

You can use SP in ARM instructions but this is deprecated in ARMv6T2 and above. You cannot use SP in Thumb instructions.

Condition flags

This instruction does not change the flags.

Note

SMLALxy cannot raise an exception. If overflow occurs on this instruction, the result wraps round without any warning.

Architectures

This ARM instruction is available in ARMv6 and above, and E variants of ARMv5T.

This 32-bit Thumb instruction is available in ARMv6T2 and above. For the ARMv7-M architecture, it is only available in an ARMv7E-M implementation.

There is no 16-bit version of this instruction in Thumb.

Examples

```
SMLALTB    r2, r3, r7, r1
SMLALBTVS r0, r1, r9, r2
```

Related references

[11.8 Condition code suffixes on page 11-319.](#)

11.117 SMLAWy

Signed Multiply-Accumulate Wide, with one 32-bit operand and one 16-bit operand, and a 32-bit accumulate value, providing the top 32 bits of the result.

Syntax

SMLAW<y>{cond} Rd, Rn, Rm, Ra

where:

<y>

is either B or T. B means use the bottom half (bits [15:0]) of *Rm*, T means use the top half (bits [31:16]) of *Rm*.

cond

is an optional condition code.

Rd

is the destination register.

Rn, Rm

are the registers holding the values to be multiplied.

Ra

is the register holding the value to be added.

Operation

SMLAWy multiplies the signed 16-bit integer from the selected half of *Rm* by the signed 32-bit integer from *Rn*, adds the top 32 bits of the 48-bit result to the 32-bit value in *Ra*, and places the result in *Rd*.

Register restrictions

You cannot use PC for any register.

You can use SP in ARM instructions but this is deprecated in ARMv6T2 and above. You cannot use SP in Thumb instructions.

Condition flags

This instruction does not affect the N, Z, C, or V flags.

If overflow occurs in the accumulation, SMLAWy sets the Q flag.

Architectures

This ARM instruction is available in ARMv6 and above, and E variants of ARMv5T.

This 32-bit Thumb instruction is available in ARMv6T2 and above. For the ARMv7-M architecture, it is only available in an ARMv7E-M implementation.

There is no 16-bit version of this instruction in Thumb.

Related references

[11.63 MRS \(PSR to general-purpose register\)](#) on page 11-410.

[11.8 Condition code suffixes](#) on page 11-319.

11.118 SMLSD

Dual 16-bit Signed Multiply with Subtraction of products and 32-bit accumulation.

Syntax

SMLSD{X}{*cond*} *Rd*, *Rn*, *Rm*, *Ra*

where:

cond

is an optional condition code.

X

is an optional parameter. If X is present, the most and least significant halfwords of the second operand are exchanged before the multiplications occur.

Rd

is the destination register.

Rn, *Rm*

are the registers holding the operands.

Ra

is the register holding the accumulate operand.

Operation

SMLSD multiplies the bottom halfword of *Rn* with the bottom halfword of *Rm*, and the top halfword of *Rn* with the top halfword of *Rm*. It then subtracts the second product from the first, adds the difference to the value in *Ra*, and stores the result to *Rd*.

Register restrictions

You cannot use PC for any register.

You can use SP in ARM instructions but this is deprecated in ARMv6T2 and above. You cannot use SP in Thumb instructions.

Condition flags

This instruction does not change the flags.

Architectures

This ARM instruction is available in ARMv6 and above.

This 32-bit Thumb instruction is available in ARMv6T2 and above. For the ARMv7-M architecture, this instruction is only available in an ARMv7E-M implementation.

There is no 16-bit version of this instruction in Thumb.

Examples

SMLSD	r1, r2, r0, r7
SMLSDX	r11, r10, r2, r3

Related references

[11.8 Condition code suffixes on page 11-319.](#)

11.119 SMLS LD

Dual 16-bit Signed Multiply with Subtraction of products and 64-bit accumulation.

Syntax

`SMLS D{X}{cond} RdLo, RdHi, Rn, Rm`

where:

X

is an optional parameter. If X is present, the most and least significant halfwords of the second operand are exchanged before the multiplications occur.

cond

is an optional condition code.

RdLo, RdHi

are the destination registers for the 64-bit result. They also hold the 64-bit accumulate operand. **RdHi** and **RdLo** must be different registers.

Rn, Rm

are the registers holding the operands.

Operation

SMLS LD multiplies the bottom halfword of *Rn* with the bottom halfword of *Rm*, and the top halfword of *Rn* with the top halfword of *Rm*. It then subtracts the second product from the first, adds the difference to the value in *RdLo, RdHi*, and stores the result to *RdLo, RdHi*.

Register restrictions

You cannot use PC for any register.

You can use SP in ARM instructions but this is deprecated in ARMv6T2 and above. You cannot use SP in Thumb instructions.

Condition flags

This instruction does not change the flags.

Architectures

This ARM instruction is available in ARMv6 and above.

This 32-bit Thumb instruction is available in ARMv6T2 and above. For the ARMv7-M architecture, it is only available in an ARMv7E-M implementation.

There is no 16-bit version of this instruction in Thumb.

Example

```
SMLS LD    r3, r0, r5, r1
```

Related references

[11.8 Condition code suffixes on page 11-319.](#)

11.120 SMMLA

Signed Most significant word Multiply with Accumulation.

Syntax

SMMLA{R}{*cond*} *Rd*, *Rn*, *Rm*, *Ra*

where:

R
R is an optional parameter. If *R* is present, the result is rounded, otherwise it is truncated.

cond
cond is an optional condition code.

Rd
Rd is the destination register.

Rn*, *Rm
Rn, *Rm* are the registers holding the operands.

Ra
Ra is a register holding the value to be added or subtracted from.

Operation

SMMLA multiplies the values from *Rn* and *Rm*, adds the value in *Ra* to the most significant 32 bits of the product, and stores the result in *Rd*.

If the optional *R* parameter is specified, 0x80000000 is added before extracting the most significant 32 bits. This has the effect of rounding the result.

Register restrictions

You cannot use PC for any register.

You can use SP in ARM instructions but this is deprecated in ARMv6T2 and above. You cannot use SP in Thumb instructions.

Condition flags

This instruction does not change the flags.

Architectures

This ARM instruction is available in ARMv6 and above.

This 32-bit Thumb instruction is available in ARMv6T2 and above. For the ARMv7-M architecture, it is only available in an ARMv7E-M implementation.

There is no 16-bit version of this instruction in Thumb.

Related references

[11.8 Condition code suffixes on page 11-319.](#)

11.121 SMMLS

Signed Most significant word Multiply with Subtraction.

Syntax

SMMLS{R}{*cond*} *Rd*, *Rn*, *Rm*, *Ra*

where:

R
R is an optional parameter. If *R* is present, the result is rounded, otherwise it is truncated.

cond
cond is an optional condition code.

Rd
Rd is the destination register.

Rn*, *Rm
Rn, *Rm* are the registers holding the operands.

Ra
Ra is a register holding the value to be added or subtracted from.

Operation

SMMLS multiplies the values from *Rn* and *Rm*, subtracts the product from the value in *Ra* shifted left by 32 bits, and stores the most significant 32 bits of the result in *Rd*.

If the optional *R* parameter is specified, 0x80000000 is added before extracting the most significant 32 bits. This has the effect of rounding the result.

Register restrictions

You cannot use PC for any register.

You can use SP in ARM instructions but this is deprecated in ARMv6T2 and above. You cannot use SP in Thumb instructions.

Condition flags

This instruction does not change the flags.

Architectures

This ARM instruction is available in ARMv6 and above.

This 32-bit Thumb instruction is available in ARMv6T2 and above. For the ARMv7-M architecture, it is only available in an ARMv7E-M implementation.

There is no 16-bit version of this instruction in Thumb.

Related references

[11.8 Condition code suffixes on page 11-319.](#)

11.122 SMMUL

Signed Most significant word Multiply.

Syntax

`SMMUL`{*R*}{*cond*} {*Rd*}, *Rn*, *Rm*

where:

R
is an optional parameter. If *R* is present, the result is rounded, otherwise it is truncated.

cond
is an optional condition code.

Rd
is the destination register.

Rn, *Rm*
are the registers holding the operands.

Ra
is a register holding the value to be added or subtracted from.

Operation

`SMMUL` multiplies the 32-bit values from *Rn* and *Rm*, and stores the most significant 32 bits of the 64-bit result to *Rd*.

If the optional *R* parameter is specified, `0x80000000` is added before extracting the most significant 32 bits. This has the effect of rounding the result.

Register restrictions

You cannot use PC for any register.

You can use SP in ARM instructions but this is deprecated in ARMv6T2 and above. You cannot use SP in Thumb instructions.

Condition flags

This instruction does not change the flags.

Architectures

This ARM instruction is available in ARMv6 and above.

This 32-bit Thumb instruction is available in ARMv6T2 and above. For the ARMv7-M architecture, it is only available in an ARMv7E-M implementation.

There is no 16-bit version of this instruction in Thumb.

Examples

<code>SMMULGE</code>	<code>r6, r4, r3</code>
<code>SMMULR</code>	<code>r2, r2, r2</code>

Related references

[11.8 Condition code suffixes on page 11-319.](#)

11.123 SMUAD

Dual 16-bit Signed Multiply with Addition of products, and optional exchange of operand halves.

Syntax

SMUAD{X}{*cond*} {*Rd*}, *Rn*, *Rm*

where:

X

is an optional parameter. If X is present, the most and least significant halfwords of the second operand are exchanged before the multiplications occur.

cond

is an optional condition code.

Rd

is the destination register.

Rn*, *Rm

are the registers holding the operands.

Operation

SMUAD multiplies the bottom halfword of *Rn* with the bottom halfword of *Rm*, and the top halfword of *Rn* with the top halfword of *Rm*. It then adds the products and stores the sum to *Rd*.

Register restrictions

You cannot use PC for any register.

You can use SP in ARM instructions but this is deprecated in ARMv6T2 and above. You cannot use SP in Thumb instructions.

Q flag

The SMUAD instruction sets the Q flag if the addition overflows.

Architectures

This ARM instruction is available in ARMv6 and above.

This 32-bit Thumb instruction is available in ARMv6T2 and above. For the ARMv7-M architecture, it is only available in an ARMv7E-M implementation.

There is no 16-bit version of this instruction in Thumb.

Examples

```
SMUAD    r2, r3, r2
```

Related references

[11.8 Condition code suffixes on page 11-319.](#)

11.124 SMULxy

Signed Multiply, with 16-bit operands and a 32-bit result.

Syntax

SMUL<x><y>{cond} {Rd}, Rn, Rm

where:

<x>

is either B or T. B means use the bottom half (bits [15:0]) of *Rn*, T means use the top half (bits [31:16]) of *Rn*.

<y>

is either B or T. B means use the bottom half (bits [15:0]) of *Rm*, T means use the top half (bits [31:16]) of *Rm*.

cond

is an optional condition code.

Rd

is the destination register.

Rn, Rm

are the registers holding the values to be multiplied.

Operation

SMULxy multiplies the 16-bit signed integers from the selected halves of *Rn* and *Rm*, and places the 32-bit result in *Rd*.

Register restrictions

You cannot use PC for any register.

You can use SP in ARM instructions but this is deprecated in ARMv6T2 and above. You cannot use SP in Thumb instructions.

Condition flags

These instructions do not affect the N, Z, C, or V flags.

Architectures

This ARM instruction is available in ARMv6 and above, and E variants of ARMv5T.

This 32-bit Thumb instruction is available in ARMv6T2 and above. For the ARMv7-M architecture, it is only available in an ARMv7E-M implementation.

There is no 16-bit version of this instruction in Thumb.

Examples

```
SMULTBEQ    r8, r7, r9
```

Related references

[11.63 MRS \(PSR to general-purpose register\)](#) on page 11-410.

[11.66 MSR \(general-purpose register to PSR\)](#) on page 11-414.

[11.8 Condition code suffixes](#) on page 11-319.

11.125 SMULL

Signed Long Multiply, with 32-bit operands and 64-bit result.

Syntax

SMULL{S}{*cond*} *RdLo*, *RdHi*, *Rn*, *Rm*

where:

S

is an optional suffix available in ARM state only. If S is specified, the condition flags are updated on the result of the operation.

cond

is an optional condition code.

RdLo, *RdHi*

are the destination registers. *RdLo* and *RdHi* must be different registers

Rn, *Rm*

are ARM registers holding the operands.

Operation

The SMULL instruction interprets the values from *Rn* and *Rm* as two's complement signed integers. It multiplies these integers and places the least significant 32 bits of the result in *RdLo*, and the most significant 32 bits of the result in *RdHi*.

Register restrictions

Rn must be different from *RdLo* and *RdHi* in architectures before ARMv6.

You cannot use PC for any register.

You can use SP in ARM instructions but this is deprecated in ARMv6T2 and above. You cannot use SP in Thumb instructions.

Condition flags

If S is specified, this instruction:

- Updates the N and Z flags according to the result.
- Does not affect the C or V flags.

Architectures

This ARM instruction is available in all versions of the ARM architecture.

This 32-bit Thumb instruction is available in ARMv6T2 and above.

There is no 16-bit version of this instruction in Thumb.

Related references

[11.8 Condition code suffixes on page 11-319.](#)

11.126 SMULWy

Signed Multiply Wide, with one 32-bit and one 16-bit operand, providing the top 32 bits of the result.

Syntax

SMULW<y>{cond} {Rd}, Rn, Rm

where:

<y>

is either B or T. B means use the bottom half (bits [15:0]) of *Rm*, T means use the top half (bits [31:16]) of *Rm*.

cond

is an optional condition code.

Rd

is the destination register.

Rn, Rm

are the registers holding the values to be multiplied.

Operation

SMULWy multiplies the signed integer from the selected half of *Rm* by the signed integer from *Rn*, and places the upper 32-bits of the 48-bit result in *Rd*.

Register restrictions

You cannot use PC for any register.

You can use SP in ARM instructions but this is deprecated in ARMv6T2 and above. You cannot use SP in Thumb instructions.

Condition flags

This instruction does not affect the N, Z, C, or V flags.

Architectures

This ARM instruction is available in ARMv6 and above, and E variants of ARMv5T.

This 32-bit Thumb instruction is available in ARMv6T2 and above. For the ARMv7-M architecture, it is only available in an ARMv7E-M implementation.

There is no 16-bit version of this instruction in Thumb.

Related references

[11.63 MRS \(PSR to general-purpose register\)](#) on page 11-410.

[11.8 Condition code suffixes](#) on page 11-319.

11.127 SMUSD

Dual 16-bit Signed Multiply with Subtraction of products, and optional exchange of operand halves.

Syntax

SMUSD{X}{*cond*} {*Rd*}, *Rn*, *Rm*

where:

X

is an optional parameter. If *X* is present, the most and least significant halfwords of the second operand are exchanged before the multiplications occur.

cond

is an optional condition code.

Rd

is the destination register.

Rn, *Rm*

are the registers holding the operands.

Operation

SMUSD multiplies the bottom halfword of *Rn* with the bottom halfword of *Rm*, and the top halfword of *Rn* with the top halfword of *Rm*. It then subtracts the second product from the first, and stores the difference to *Rd*.

Register restrictions

You cannot use PC for any register.

You can use SP in ARM instructions but this is deprecated in ARMv6T2 and above. You cannot use SP in Thumb instructions.

Architectures

This ARM instruction is available in ARMv6 and above.

This 32-bit Thumb instruction is available in ARMv6T2 and above. For the ARMv7-M architecture, it is only available in an ARMv7E-M implementation.

There is no 16-bit version of this instruction in Thumb.

Example

```
SMUSDXNE    r0, r1, r2
```

Related references

[11.8 Condition code suffixes on page 11-319.](#)

11.128 SRS

Store Return State onto a stack.

Syntax

`SRS{addr_mode}{cond} sp{!}, #modenum`

`SRS{addr_mode}{cond} #modenum{!}` ; This is pre-UAL syntax

where:

addr_mode

is any one of the following:

IA

Increment address After each transfer

IB

Increment address Before each transfer (ARM only)

DA

Decrement address After each transfer (ARM only)

DB

Decrement address Before each transfer (Full Descending stack).

If *addr_mode* is omitted, it defaults to Increment After. You can also use stack oriented addressing mode suffixes, for example, when implementing stacks.

cond

is an optional condition code.

————— **Note** —————

cond is permitted only in Thumb code, using a preceding IT instruction. This is an unconditional instruction in ARM.

!

is an optional suffix. If ! is present, the final address is written back into the SP of the mode specified by *modenum*.

modenum

specifies the number of the mode whose banked SP is used as the base register. You must use only the defined mode numbers.

Operation

SRS stores the LR and the SPSR of the current mode, at the address contained in SP of the mode specified by *modenum*, and the following word respectively. Optionally updates SP of the mode specified by *modenum*. This is compatible with the normal use of the STM instruction for stack accesses.

————— **Note** —————

For full descending stack, you must use SRSFD or SRSDB.

Usage

You can use SRS to store return state for an exception handler on a different stack from the one automatically selected.

Notes

Where addresses are not word-aligned, SRS ignores the least significant two bits of the specified address.

The time order of the accesses to individual words of memory generated by SRS is not architecturally defined. Do not use this instruction on memory-mapped I/O locations where access order matters.

Do not use SRS in User and System modes because these modes do not have a SPSR.

SRS is not permitted in a non-secure state if *modenum* specifies monitor mode.

Architectures

This ARM instruction is available in ARMv6 and above.

This 32-bit Thumb instruction is available in ARMv6T2 and above, except the ARMv7-M architecture.

There is no 16-bit version of this instruction.

Example

```
R13_usr EQU 16
SRSFD sp,#R13_usr
```

Related concepts

[4.15 Stack implementation using LDM and STM](#) on page 4-82.

[2.4 Processor modes, and privileged and unprivileged software execution](#) on page 2-38.

Related references

[11.41 LDM](#) on page 11-372.

[11.8 Condition code suffixes](#) on page 11-319.

11.129 SSAT

Signed Saturate to any bit position, with optional shift before saturating.

Syntax

SSAT{*cond*} *Rd*, #*sat*, *Rm*{, *shift*}

where:

cond

is an optional condition code.

Rd

is the destination register.

sat

specifies the bit position to saturate to, in the range 1 to 32.

Rm

is the register containing the operand.

shift

is an optional shift. It must be one of the following:

ASR #*n*

where *n* is in the range 1-32 (ARM) or 1-31 (Thumb)

LSL #*n*

where *n* is in the range 0-31.

Operation

The SSAT instruction applies the specified shift, then saturates a signed value to the signed range $-2^{\text{sat}-1} \leq x \leq 2^{\text{sat}-1} - 1$.

Register restrictions

You cannot use PC for any register.

You can use SP in ARM instructions but this is deprecated in ARMv6T2 and above. You cannot use SP in Thumb instructions.

Q flag

If saturation occurs, this instruction sets the Q flag. To read the state of the Q flag, use an MRS instruction.

Architectures

This ARM instruction is available in ARMv6 and above.

This 32-bit Thumb instruction is available in ARMv6T2 and above.

There is no 16-bit version of this instruction in Thumb.

Example

```
SSAT    r7, #16, r7, LSL #4
```

Related references

[11.130 SSAT16 on page 11-495.](#)

[11.63 MRS \(PSR to general-purpose register\) on page 11-410.](#)

[11.8 Condition code suffixes on page 11-319.](#)

11.130 SSAT16

Parallel halfword Saturate.

Syntax

SSAT16{*cond*} *Rd*, #*sat*, *Rn*

where:

cond

is an optional condition code.

Rd

is the destination register.

sat

specifies the bit position to saturate to, in the range 1 to 16.

Rn

is the register holding the operand.

Operation

Halfword-wise signed saturation to any bit position.

The SSAT16 instruction saturates each signed halfword to the signed range $-2^{\text{sat}-1} \leq x \leq 2^{\text{sat}-1} - 1$.

Register restrictions

You cannot use PC for any register.

You can use SP in ARM instructions but this is deprecated in ARMv6T2 and above. You cannot use SP in Thumb instructions.

Q flag

If saturation occurs on either halfword, this instruction sets the Q flag. To read the state of the Q flag, use an MRS instruction.

Architectures

This ARM instruction is available in ARMv6 and above.

This 32-bit Thumb instruction is available in ARMv6T2 and above. For the ARMv7-M architecture, it is only available in an ARMv7E-M implementation.

There is no 16-bit version of this instruction in Thumb.

Correct example

```
SSAT16 r7, #12, r7
```

Incorrect example

```
SSAT16 r1, #16, r2, LSL #4 ; shifts not permitted with halfword
                           ; saturations
```

Related references

[11.63 MRS \(PSR to general-purpose register\)](#) on page 11-410.

[11.8 Condition code suffixes](#) on page 11-319.

11.131 SSAX

Signed parallel subtract and add halfwords with exchange.

Syntax

SSAX{*cond*} {*Rd*}, *Rn*, *Rm*

where:

cond
is an optional condition code.

Rd
is the destination register.

Rm, *Rn*
are the ARM registers holding the operands.

Operation

This instruction exchanges the two halfwords of the second operand, then performs a subtraction on the two top halfwords of the operands and an addition on the bottom two halfwords. It writes the results into the corresponding halfwords of the destination. The results are modulo 2^{16} . It sets the APSR GE flags.

Register restrictions

You cannot use PC for any register.

You can use SP in ARM instructions but this is deprecated in ARMv6T2 and above. You cannot use SP in Thumb instructions.

GE flags

This instruction does not affect the N, Z, C, V, or Q flags.

It sets the GE flags in the APSR as follows:

GE[1:0]
for bits[15:0] of the result.

GE[3:2]
for bits[31:16] of the result.

It sets a pair of GE flags to 1 to indicate that the corresponding result is greater than or equal to zero. This is equivalent to an ADDS or SUBS instruction setting the N and V condition flags to the same value, so that the GE condition passes.

You can use these flags to control a following SEL instruction.

————— **Note** —————

GE[1:0] are set or cleared together, and GE[3:2] are set or cleared together.

Architectures

This ARM instruction is available in ARMv6 and above.

This 32-bit Thumb instruction is available in ARMv6T2 and above. For the ARMv7-M architecture, it is only available in an ARMv7E-M implementation.

There is no 16-bit version of this instruction in Thumb.

Related references

[11.102 SEL on page 11-464.](#)

[11.8 Condition code suffixes on page 11-319.](#)

11.132 SSUB8

Signed parallel byte-wise subtraction.

Syntax

`SSUB8{cond} {Rd}, Rn, Rm`

where:

cond
is an optional condition code.

Rd
is the destination register.

Rm, Rn
are the ARM registers holding the operands.

Operation

This instruction subtracts each byte of the second operand from the corresponding byte of the first operand and writes the results into the corresponding bytes of the destination. The results are modulo 2^8 . It sets the APSR GE flags.

Register restrictions

You cannot use PC for any register.

You can use SP in ARM instructions but this is deprecated in ARMv6T2 and above. You cannot use SP in Thumb instructions.

GE flags

This instruction does not affect the N, Z, C, V, or Q flags.

It sets the GE flags in the APSR as follows:

GE[0]
for bits[7:0] of the result.

GE[1]
for bits[15:8] of the result.

GE[2]
for bits[23:16] of the result.

GE[3]
for bits[31:24] of the result.

It sets a GE flag to 1 to indicate that the corresponding result is greater than or equal to zero. This is equivalent to a SUBS instruction setting the N and V condition flags to the same value, so that the GE condition passes.

You can use these flags to control a following SEL instruction.

Architectures

This ARM instruction is available in ARMv6 and above.

This 32-bit Thumb instruction is available in ARMv6T2 and above. For the ARMv7-M architecture, it is only available in an ARMv7E-M implementation.

There is no 16-bit version of this instruction in Thumb.

Related references

[11.102 SEL on page 11-464.](#)

[11.8 Condition code suffixes on page 11-319.](#)

11.133 SSUB16

Signed parallel halfword-wise subtraction.

Syntax

SSUB16{*cond*} {*Rd*}, *Rn*, *Rm*

where:

cond
is an optional condition code.

Rd
is the destination register.

Rm, *Rn*
are the ARM registers holding the operands.

Operation

This instruction subtracts each halfword of the second operand from the corresponding halfword of the first operand and writes the results into the corresponding halfwords of the destination. The results are modulo 2^{16} . It sets the APSR GE flags.

Register restrictions

You cannot use PC for any register.

You can use SP in ARM instructions but this is deprecated in ARMv6T2 and above. You cannot use SP in Thumb instructions.

GE flags

This instruction does not affect the N, Z, C, V, or Q flags.

It sets the GE flags in the APSR as follows:

GE[1:0]
for bits[15:0] of the result.

GE[3:2]
for bits[31:16] of the result.

It sets a pair of GE flags to 1 to indicate that the corresponding result is greater than or equal to zero. This is equivalent to a SUBS instruction setting the N and V condition flags to the same value, so that the GE condition passes.

You can use these flags to control a following SEL instruction.

————— **Note** —————

GE[1:0] are set or cleared together, and GE[3:2] are set or cleared together.

Architectures

This ARM instruction is available in ARMv6 and above.

This 32-bit Thumb instruction is available in ARMv6T2 and above. For the ARMv7-M architecture, it is only available in an ARMv7E-M implementation.

There is no 16-bit version of this instruction in Thumb.

Related references

[11.102 SEL on page 11-464.](#)

[11.8 Condition code suffixes on page 11-319.](#)

11.134 STC and STC2

Transfer Data between memory and Coprocessor.

Syntax

op{L}{*cond*} *coproc*, *CRd*, [*Rn*]

op{L}{*cond*} *coproc*, *CRd*, [*Rn*, #{-}*offset*] ; offset addressing

op{L}{*cond*} *coproc*, *CRd*, [*Rn*, #{-}*offset*]! ; pre-index addressing

op{L}{*cond*} *coproc*, *CRd*, [*Rn*], #{-}*offset* ; post-index addressing

op{L}{*cond*} *coproc*, *CRd*, [*Rn*], {*option*}

where:

op

is one of STC or STC2.

cond

is an optional condition code.

In ARM code, *cond* is not permitted for STC2.

L

is an optional suffix specifying a long transfer.

coproc

is the name of the coprocessor the instruction is for. The standard name is *pn*, where *n* is an integer in the range 0 to 15.

CRd

is the coprocessor register to store.

Rn

is the register on which the memory address is based. If PC is specified, the value used is the address of the current instruction plus eight.

-

is an optional minus sign. If - is present, the offset is subtracted from *Rn*. Otherwise, the offset is added to *Rn*.

offset

is an expression evaluating to a multiple of 4, in the range 0 to 1020.

!

is an optional suffix. If ! is present, the address including the offset is written back into *Rn*.

option

is a coprocessor option in the range 0-255, enclosed in braces.

Usage

The use of these instructions depends on the coprocessor. See the coprocessor documentation for details.

Architectures

STC is available in all versions of the ARM architecture.

STC2 is available in ARMv5T and above.

These 32-bit Thumb instructions are available in ARMv6T2 and above.

There are no 16-bit versions of these instructions in Thumb.

Register restrictions

You cannot use PC for *Rn* in the pre-index and post-index instructions. These are the forms that write back to *Rn*.

You cannot use PC for *Rn* in Thumb STC and STC2 instructions.

ARM STC and STC2 instructions where *Rn* is PC, are deprecated in ARMv6T2 and above.

Related concepts

[7.5 Register-relative and PC-relative expressions](#) on page 7-142.

[6.16 Address alignment](#) on page 6-134.

Related references

[11.8 Condition code suffixes](#) on page 11-319.

11.135 STM

Store Multiple registers.

Syntax

```
STM{addr_mode}{cond} Rn{!}, regList{^}
```

where:

addr_mode

is any one of the following:

IA

Increment address After each transfer. This is the default, and can be omitted.

IB

Increment address Before each transfer (ARM only).

DA

Decrement address After each transfer (ARM only).

DB

Decrement address Before each transfer.

You can also use the stack-oriented addressing mode suffixes, for example when implementing stacks.

cond

is an optional condition code.

Rn

is the *base register*, the ARM register holding the initial address for the transfer. *Rn* must not be PC.

!

is an optional suffix. If ! is present, the final address is written back into *Rn*.

regList

is a list of one or more registers to be stored, enclosed in braces. It can contain register ranges. It must be comma-separated if it contains more than one register or register range. Any combination of registers R0 to R15 (PC) can be transferred in ARM state, but there are some restrictions in Thumb state.

^

is an optional suffix, available in ARM state only. You must not use it in User mode or System mode. Data is transferred into or out of the User mode registers instead of the current mode registers.

Restrictions on reglist in 32-bit Thumb instructions

In 32-bit Thumb instructions:

- The SP cannot be in the list.
- The PC cannot be in the list.
- There must be two or more registers in the list.

If you write an STM instruction with only one register in *regList*, the assembler automatically substitutes the equivalent STR instruction. Be aware of this when comparing disassembly listings with source code.

You can use the `--diag_warning 1645` assembler command-line option to check when an instruction substitution occurs.

Restrictions on reglist in ARM instructions

ARM store instructions can have SP and PC in the *regList* but these instructions that include SP or PC in the *regList* are deprecated in ARMv6T2 and above.

16-bit instruction

A 16-bit version of this instruction is available in Thumb code.

The following restrictions apply to the 16-bit instruction:

- All registers in *regList* must be Lo registers.
- *Rn* must be a Lo register.
- *addr_mode* must be omitted (or IA), meaning increment address after each transfer.
- Writeback must be specified for STM instructions.

Note

16-bit Thumb STM instructions with writeback that specify *Rn* as the lowest register in the *regList* are deprecated in ARMv6T2 and above.

In addition, the PUSH and POP instructions are subsets of the STM and LDM instructions and can therefore be expressed using the STM and LDM instructions. Some forms of PUSH and POP are also 16-bit instructions.

Storing the base register, with writeback

In ARM or 16-bit Thumb instructions, if *Rn* is in *regList*, and writeback is specified with the ! suffix:

- If the instruction is `STM{addr_mode}{cond}` and *Rn* is the lowest-numbered register in *regList*, the initial value of *Rn* is stored. These instructions are deprecated in ARMv6T2 and above.
- Otherwise, the stored value of *Rn* cannot be relied on, so these instructions are not permitted.

32-bit Thumb instructions are not permitted if *Rn* is in *regList*, and writeback is specified with the ! suffix.

Correct example

```
STMDB    r1!, {r3-r6, r11, r12}
```

Incorrect example

```
STM      r5!, {r5, r4, r9} ; value stored for R5 unknown
```

Related concepts

[4.15 Stack implementation using LDM and STM](#) on page 4-82.

[6.16 Address alignment](#) on page 6-134.

Related references

[11.75 POP](#) on page 11-429.

[11.8 Condition code suffixes](#) on page 11-319.

11.136 STR (immediate offset)

Store with immediate offset, pre-indexed immediate offset, or post-indexed immediate offset.

Syntax

STR{*type*}{*cond*} *Rt*, [*Rn* {, #*offset*}] ; immediate offset

STR{*type*}{*cond*} *Rt*, [*Rn*, #*offset*]! ; pre-indexed

STR{*type*}{*cond*} *Rt*, [*Rn*], #*offset* ; post-indexed

STRD{*cond*} *Rt*, *Rt2*, [*Rn* {, #*offset*}] ; immediate offset, doubleword

STRD{*cond*} *Rt*, *Rt2*, [*Rn*, #*offset*]! ; pre-indexed, doubleword

STRD{*cond*} *Rt*, *Rt2*, [*Rn*], #*offset* ; post-indexed, doubleword

where:

type

can be any one of:

B

Byte.

H

Halfword.

-

omitted, for Word.

cond

is an optional condition code.

Rt

is the register to store.

Rn

is the register on which the memory address is based.

offset

is an offset. If *offset* is omitted, the address is the contents of *Rn*.

Rt2

is the additional register to store for doubleword operations.

Not all options are available in every instruction set and architecture.

Offset ranges and architectures

The following table shows the ranges of offsets and availability of this instruction:

Table 11-15 Offsets and architectures, STR, word, halfword, and byte

Instruction	Immediate offset	Pre-indexed	Post-indexed	Arch.
ARM, word or byte	-4095 to 4095	-4095 to 4095	-4095 to 4095	All
ARM, halfword	-255 to 255	-255 to 255	-255 to 255	All
ARM, doubleword	-255 to 255	-255 to 255	-255 to 255	5E
Thumb 32-bit encoding, word, halfword, or byte	-255 to 4095	-255 to 255	-255 to 255	T2
Thumb 32-bit encoding, doubleword	-1020 to 1020 ^{ab}	-1020 to 1020 ^{ab}	-1020 to 1020 ^{ab}	T2
Thumb 16-bit encoding, word ^{ac}	0 to 124 ^{ab}	Not available	Not available	T

^{ab} Must be divisible by 4.

^{ac} *Rt* and *Rn* must be in the range R0-R7.

Table 11-15 Offsets and architectures, STR, word, halfword, and byte (continued)

Instruction	Immediate offset	Pre-indexed	Post-indexed	Arch.
Thumb 16-bit encoding, halfword ^{ac}	0 to 62 ^{ac}	Not available	Not available	T
Thumb 16-bit encoding, byte ^{ac}	0 to 31	Not available	Not available	T
Thumb 16-bit encoding, word, Rn is SP ^{ad}	0 to 1020 ^{ab}	Not available	Not available	T

Notes about the Architecture column

Entries in the Architecture column indicate that the instructions are available as follows:

All

All versions of the ARM architecture.

5E

The ARMv5TE, ARMv6*, and ARMv7 architectures.

T2

The ARMv6T2 and above architectures.

T

The ARMv4T, ARMv5T*, ARMv6*, and ARMv7 architectures.

Register restrictions

Rn must be different from Rt in the pre-index and post-index forms.

Doubleword register restrictions

Rn must be different from Rt2 in the pre-index and post-index forms.

For Thumb instructions, you must not specify SP or PC for either Rt or Rt2.

For ARM instructions:

- Rt must be an even-numbered register.
- Rt must not be LR.
- ARM strongly recommends that you do not use R12 for Rt.
- Rt2 must be R(t + 1).

Use of PC

In ARM instructions you can use PC for Rt in STR word instructions and PC for Rn in STR instructions with immediate offset syntax (that is the forms that do not writeback to the Rn). However, this is deprecated in ARMv6T2 and above.

Other uses of PC are not permitted in these ARM instructions.

In Thumb code, using PC in STR instructions is not permitted.

Use of SP

You can use SP for Rn.

In ARM code, you can use SP for Rt in word instructions. You can use SP for Rt in non-word instructions in ARM code but this is deprecated in ARMv6T2 and above.

In Thumb code, you can use SP for Rt in word instructions only. All other use of SP for Rt in this instruction is not permitted in Thumb code.

^{ad} Rt must be in the range R0-R7.
^{ae} Must be divisible by 2.

Example

```
STR    r2,[r9,#consta-struct] ; consta-struct is an expression  
                                     ; evaluating to a constant in  
                                     ; the range 0-4095.
```

Related concepts

[6.16 Address alignment](#) on page 6-134.

Related references

[11.8 Condition code suffixes](#) on page 11-319.

11.137 STR (register offset)

Store with register offset, pre-indexed register offset, or post-indexed register offset.

Syntax

STR{*type*}{*cond*} *Rt*, [*Rn*, $\pm Rm$ {, *shift*}] ; register offset

STR{*type*}{*cond*} *Rt*, [*Rn*, $\pm Rm$ {, *shift*}]! ; pre-indexed ; ARM only

STR{*type*}{*cond*} *Rt*, [*Rn*], $\pm Rm$ {, *shift*} ; post-indexed ; ARM only

STRD{*cond*} *Rt*, *Rt2*, [*Rn*, $\pm Rm$] ; register offset, doubleword ; ARM only

STRD{*cond*} *Rt*, *Rt2*, [*Rn*, $\pm Rm$]! ; pre-indexed, doubleword ; ARM only

STRD{*cond*} *Rt*, *Rt2*, [*Rn*], $\pm Rm$; post-indexed, doubleword ; ARM only

where:

type

can be any one of:

B

Byte.

H

Halfword.

-

omitted, for Word.

cond

is an optional condition code.

Rt

is the register to store.

Rn

is the register on which the memory address is based.

Rm

is a register containing a value to be used as the offset. $-Rm$ is not permitted in Thumb code.

shift

is an optional shift.

Rt2

is the additional register to store for doubleword operations.

Not all options are available in every instruction set and architecture.

Offset register and shift options

The following table shows the ranges of offsets and availability of this instruction:

Table 11-16 Options and architectures, STR (register offsets)

Instruction	$+/-Rm$ ^{af}	shift			Arch.
ARM, word or byte	$+/-Rm$	LSL #0-31	LSR #1-32		All
		ASR #1-32	ROR #1-31	RRX	
ARM, halfword	$+/-Rm$	Not available			All
ARM, doubleword	$+/-Rm$	Not available			5E

^{af} Where $+/-Rm$ is shown, you can use $-Rm$, $+Rm$, or Rm . Where $+Rm$ is shown, you cannot use $-Rm$.
^{ag} *Rt*, *Rn*, and *Rm* must all be in the range R0-R7.

Table 11-16 Options and architectures, STR (register offsets) (continued)

Instruction	+/-Rm ^{af}	shift		Arch.
Thumb 32-bit encoding, word, halfword, or byte	+Rm	LSL #0-3		T2
Thumb 16-bit encoding, all except doubleword ^{ag}	+Rm	Not available		T

Notes about the Architecture column

Entries in the Architecture column indicate that the instructions are available as follows:

All

All versions of the ARM architecture.

5E

The ARMv5TE, ARMv6*, and ARMv7 architectures.

T2

The ARMv6T2 and above architectures.

T

The ARMv4T, ARMv5T*, ARMv6*, and ARMv7 architectures.

Register restrictions

In the pre-index and post-index forms:

- Rn must be different from Rt.
- Rn must be different from Rm in architectures before ARMv6.

Doubleword register restrictions

For ARM instructions:

- Rt must be an even-numbered register.
- Rt must not be LR.
- ARM strongly recommends that you do not use R12 for Rt.
- Rt2 must be R(t + 1).
- Rn must be different from Rt2 in the pre-index and post-index forms.

Use of PC

In ARM instructions you can use PC for Rt in STR word instructions, and you can use PC for Rn in STR instructions with register offset syntax (that is, the forms that do not writeback to the Rn). However, this is deprecated in ARMv6T2 and above.

Other uses of PC are not permitted in ARM instructions.

Use of PC in STR Thumb instructions is not permitted.

Use of SP

You can use SP for Rn.

In ARM code, you can use SP for Rt in word instructions. You can use SP for Rt in non-word ARM instructions but this is deprecated in ARMv6T2 and above.

You can use SP for Rm in ARM instructions but this is deprecated in ARMv6T2 and above.

In Thumb code, you can use SP for Rt in word instructions only. All other use of SP for Rt in this instruction is not permitted in Thumb code.

Use of SP for Rm is not permitted in Thumb state.

Related concepts

[6.16 Address alignment on page 6-134.](#)

Related references

[11.8 Condition code suffixes](#) on page 11-319.

11.138 STR, unprivileged

Unprivileged Store, byte, halfword, or word.

Syntax

STR{*type*}T{*cond*} *Rt*, [*Rn* {, #*offset*}] ; immediate offset (Thumb, 32-bit encoding only)

STR{*type*}T{*cond*} *Rt*, [*Rn*] {, #*offset*} ; post-indexed (ARM only)

STR{*type*}T{*cond*} *Rt*, [*Rn*], ±*Rm* {, *shift*} ; post-indexed (register) (ARM only)

where:

type

can be any one of:

B

Byte.

H

Halfword.

-

omitted, for Word.

cond

is an optional condition code.

Rt

is the register to load or store.

Rn

is the register on which the memory address is based.

offset

is an offset. If offset is omitted, the address is the value in *Rn*.

Rm

is a register containing a value to be used as the offset. *Rm* must not be PC.

shift

is an optional shift.

Operation

When these instructions are executed by privileged software, they access memory with the same restrictions as they would have if they were executed by unprivileged software.

When executed by unprivileged software, these instructions behave in exactly the same way as the corresponding store instruction, for example STRBT behaves in the same way as STRB.

Offset ranges and architectures

The following table shows the ranges of offsets and availability of this instruction:

Table 11-17 Offsets and architectures, STR (User mode)

Instruction	Immediate offset	Post-indexed	+/- <i>Rm</i> ^{ah}	shift	Arch.
ARM, word or byte	Not available	-4095 to 4095	+/- <i>Rm</i>	LSL #0-31	All
				LSR #1-32	
				ASR #1-32	
				ROR #1-31	

^{ah} You can use -*Rm*, +*Rm*, or *Rm*.

Table 11-17 Offsets and architectures, STR (User mode) (continued)

Instruction	Immediate offset	Post-indexed	+/-Rm ^{ah}	shift	Arch.
				RRX	
ARM, halfword	Not available	-255 to 255	+/-Rm	Not available	T2
Thumb 32-bit encoding, word, halfword, or byte	0 to 255	Not available	Not available		T2

Notes about the Architecture column

Entries in the Architecture column indicate that the instructions are available as follows:

All

All versions of the ARM architecture.

T2

The ARMv6T2 and above architectures.

Related concepts

[6.16 Address alignment](#) on page 6-134.

Related references

[11.8 Condition code suffixes](#) on page 11-319.

11.139 STREX

Store Register Exclusive.

Syntax

STREX{*cond*} *Rd*, *Rt*, [*Rn* {, #*offset*}]

STREXB{*cond*} *Rd*, *Rt*, [*Rn*]

STREXH{*cond*} *Rd*, *Rt*, [*Rn*]

STREXD{*cond*} *Rd*, *Rt*, *Rt2*, [*Rn*]

where:

cond

is an optional condition code.

Rd

is the destination register for the returned status.

Rt

is the register to store.

Rt2

is the second register for doubleword stores.

Rn

is the register on which the memory address is based.

offset

is an optional offset applied to the value in *Rn*. *offset* is permitted only in Thumb instructions. If *offset* is omitted, an offset of 0 is assumed.

Operation

STREX performs a conditional store to memory. The conditions are as follows:

- If the physical address does not have the Shared TLB attribute, and the executing processor has an outstanding tagged physical address, the store takes place, the tag is cleared, and the value 0 is returned in *Rd*.
- If the physical address does not have the Shared TLB attribute, and the executing processor does not have an outstanding tagged physical address, the store does not take place, and the value 1 is returned in *Rd*.
- If the physical address has the Shared TLB attribute, and the physical address is tagged as exclusive access for the executing processor, the store takes place, the tag is cleared, and the value 0 is returned in *Rd*.
- If the physical address has the Shared TLB attribute, and the physical address is not tagged as exclusive access for the executing processor, the store does not take place, and the value 1 is returned in *Rd*.

Restrictions

PC must not be used for any of *Rd*, *Rt*, *Rt2*, or *Rn*.

For STREX, *Rd* must not be the same register as *Rt*, *Rt2*, or *Rn*.

For ARM instructions:

- SP can be used but use of SP for any of *Rd*, *Rt*, or *Rt2* is deprecated in ARMv6T2 and above.
- For STREXD, *Rt* must be an even numbered register, and not LR.
- *Rt2* must be $R(t+1)$.
- *offset* is not permitted.

For Thumb instructions:

- SP can be used for *Rn*, but must not be used for any of *Rd*, *Rt*, or *Rt2*.
- The value of *offset* can be any multiple of four in the range 0-1020.

Usage

Use LDREX and STREX to implement interprocess communication in multiple-processor and shared-memory systems.

For reasons of performance, keep the number of instructions between corresponding LDREX and STREX instructions to a minimum.

Note

The address used in a STREX instruction must be the same as the address in the most recently executed LDREX instruction.

Architectures

ARM STREX is available in ARMv6 and above.

ARM STREXB, STREXD, and STREXH are available in ARMv6K and above.

All these 32-bit Thumb instructions are available in ARMv6T2 and above, except that STREXD is not available in the ARMv7-M architecture.

There are no 16-bit versions of these instructions.

Examples

```

MOV r1, #0x1           ; load the 'lock taken' value
try
LDREX r0, [LockAddr]  ; load the lock value
CMP r0, #0             ; is the lock free?
STREXEQ r0, r1, [LockAddr] ; try and claim the lock
CMPEQ r0, #0          ; did this succeed?
BNE try                ; no - try again
...                   ; yes - we have the lock

```

Related concepts

[6.16 Address alignment](#) on page 6-134.

Related references

[11.8 Condition code suffixes](#) on page 11-319.

11.140 SUB

Subtract without carry.

Syntax

SUB{S}{*cond*} {*Rd*}, *Rn*, *Operand2*

SUB{*cond*} {*Rd*}, *Rn*, #*imm12* ; Thumb, 32-bit encoding only

where:

S

is an optional suffix. If S is specified, the condition flags are updated on the result of the operation.

cond

is an optional condition code.

Rd

is the destination register.

Rn

is the register holding the first operand.

Operand2

is a flexible second operand.

imm12

is any value in the range 0-4095.

Operation

The SUB instruction subtracts the value of *Operand2* or *imm12* from the value in *Rn*.

In certain circumstances, the assembler can substitute one instruction for another. Be aware of this when reading disassembly listings.

Use of PC and SP in Thumb instructions

In general, you cannot use PC (R15) for *Rd*, or any operand. The exception is you can use PC for *Rn* in 32-bit Thumb SUB instructions, with a constant *Operand2* value in the range 0-4095, and no S suffix. These instructions are useful for generating PC-relative addresses. Bit[1] of the PC value reads as 0 in this case, so that the base address for the calculation is always word-aligned.

Generally, you cannot use SP (R13) for *Rd*, or any operand, except that you can use SP for *Rn*.

Use of PC and SP in ARM instructions

You cannot use PC for *Rd* or any operand in a SUB instruction that has a register-controlled shift.

In SUB instructions without register-controlled shift, use of PC is deprecated except for the following cases:

- Use of PC for *Rd*.
- Use of PC for *Rn* in the instruction SUB{*cond*} *Rd*, *Rn*, #Constant.

If you use PC (R15) as *Rn* or *Rm*, the value used is the address of the instruction plus 8.

If you use PC as *Rd*:

- Execution branches to the address corresponding to the result.
- If you use the S suffix, see the SUBS *pc*, *l*r instruction.

You can use SP for *Rn* in SUB instructions, however, SUBS *PC*, *SP*, #Constant is deprecated.

You can use SP in SUB (register) if *Rn* is SP and *shift* is omitted or LSL #1, LSL #2, or LSL #3.

Other uses of SP in ARM SUB instructions are deprecated.

————— **Note** —————

The deprecation of SP and PC in ARM instructions is only in ARMv6T2 and above.

Condition flags

If S is specified, the SUB instruction updates the N, Z, C and V flags according to the result.

16-bit instructions

The following forms of this instruction are available in Thumb code, and are 16-bit instructions:

SUBS *Rd*, *Rn*, *Rm*

Rd, *Rn* and *Rm* must all be Lo registers. This form can only be used outside an IT block.

SUB{*cond*} *Rd*, *Rn*, *Rm*

Rd, *Rn* and *Rm* must all be Lo registers. This form can only be used inside an IT block.

SUBS *Rd*, *Rn*, #*imm*

imm range 0-7. *Rd* and *Rn* must both be Lo registers. This form can only be used outside an IT block.

SUB{*cond*} *Rd*, *Rn*, #*imm*

imm range 0-7. *Rd* and *Rn* must both be Lo registers. This form can only be used inside an IT block.

SUBS *Rd*, *Rd*, #*imm*

imm range 0-255. *Rd* must be a Lo register. This form can only be used outside an IT block.

SUB{*cond*} *Rd*, *Rd*, #*imm*

imm range 0-255. *Rd* must be a Lo register. This form can only be used inside an IT block.

SUB{*cond*} SP, SP, #*imm*

imm range 0-508, word aligned.

Example

```
SUBS    r8, r6, #240    ; sets the flags based on the result
```

Multiword arithmetic examples

These instructions subtract one 96-bit integer contained in R9, R10, and R11 from another 96-bit integer contained in R6, R7, and R8, and place the result in R3, R4, and R5:

```
SUBS    r3, r6, r9
SBCS    r4, r7, r10
SBC     r5, r8, r11
```

For clarity, the above examples use consecutive registers for multiword values. There is no requirement to do this. The following, for example, is perfectly valid:

```
SUBS    r6, r6, r9
SBCS    r9, r2, r1
SBC     r2, r8, r11
```

Related references

[11.3 Flexible second operand \(Operand2\) on page 11-312.](#)

[11.141 SUBS *pc*, *lr* on page 11-515.](#)

[11.8 Condition code suffixes on page 11-319.](#)

Related information

[Handling Processor Exceptions.](#)

11.141 SUBS pc, lr

Exception return, without popping anything from the stack.

Syntax

`SUBS{cond} pc, lr, #imm` ; ARM and Thumb code

`MOVS{cond} pc, lr` ; ARM and Thumb code

`op1S{cond} pc, Rn, #imm` ; ARM code only and is deprecated

`op1S{cond} pc, Rn, Rm {, shift}` ; ARM code only and is deprecated

`op2S{cond} pc, #imm` ; ARM code only and is deprecated

`op2S{cond} pc, Rm {, shift}` ; ARM code only and is deprecated

where:

op1

is one of ADC, ADD, AND, BIC, EOR, ORN, ORR, RSB, RSC, SBC, and SUB.

op2

is one of MOV and MVN.

cond

is an optional condition code.

imm

is an immediate value. In Thumb code, it is limited to the range 0-255. In ARM code, it is a flexible second operand.

Rn

is the first operand register. ARM deprecates the use of any register except LR.

Rm

is the optionally shifted second or only operand register.

shift

is an optional condition code.

Usage

`SUBS pc, lr, #imm` subtracts a value from the link register and loads the PC with the result, then copies the SPSR to the CPSR.

You can use `SUBS pc, lr, #imm` to return from an exception if there is no return state on the stack. The value of *#imm* depends on the exception to return from.

Notes

`SUBS pc, lr, #imm` writes an address to the PC. The alignment of this address must be correct for the instruction set in use after the exception return:

- For a return to ARM, the address written to the PC must be word-aligned.
- For a return to Thumb, the address written to the PC must be halfword-aligned.
- For a return to Jazelle, there are no alignment restrictions on the address written to the PC.

No special precautions are required in software to follow these rules, if you use the instruction to return after a valid exception entry mechanism.

In Thumb, only `SUBS{cond} pc, lr, #imm` is a valid instruction. `MOVS pc, lr` is a synonym of `SUBS pc, lr, #0`. Other instructions are undefined.

In ARM, only SUBS{*cond*} pc, lr, #*imm* and MOVS{*cond*} pc, lr are valid instructions. Other instructions are deprecated in ARMv6T2 and above.

———— **Caution** ————

Do not use these instructions in User mode or System mode. The assembler cannot warn you about this.

Architectures

This ARM instruction is available in all versions of the ARM architecture.

This 32-bit Thumb instruction is available in ARMv6T2 and above, except the ARMv7-M architecture.

There is no 16-bit version of this instruction in Thumb.

Related references

[11.14 AND](#) on page 11-331.

[11.57 MOV](#) on page 11-403.

[11.3 Flexible second operand \(Operand2\)](#) on page 11-312.

[11.10 ADD](#) on page 11-322.

[11.8 Condition code suffixes](#) on page 11-319.

11.142 SVC

SuperVisor Call.

Syntax

`SVC{cond} #imm`

where:

cond

is an optional condition code.

imm

is an expression evaluating to an integer in the range:

- 0 to $2^{24}-1$ (a 24-bit value) in an ARM instruction.
- 0-255 (an 8-bit value) in a Thumb instruction.

Operation

The SVC instruction causes an exception. This means that the processor mode changes to Supervisor, the CPSR is saved to the Supervisor mode SPSR, and execution branches to the SVC vector.

imm is ignored by the processor. However, it can be retrieved by the exception handler to determine what service is being requested.

————— **Note** —————

SVC was called SWI in earlier versions of the ARM assembly language. SWI instructions disassemble to SVC, with a comment to say that this was formerly SWI.

Condition flags

This instruction does not change the flags.

Architectures

This ARM instruction is available in all versions of the ARM architecture.

This 16-bit Thumb instruction is available in all T variants of the ARM architecture.

There is no 32-bit version of this instruction in Thumb.

Related references

[11.8 Condition code suffixes on page 11-319.](#)

Related information

[Handling Processor Exceptions.](#)

11.143 SWP and SWPB

Swap data between registers and memory.

Syntax

`SWP{B}{cond} Rt, Rt2, [Rn]`

where:

cond

is an optional condition code.

B

is an optional suffix. If *B* is present, a byte is swapped. Otherwise, a 32-bit word is swapped.

Rt

is the destination register. *Rt* must not be PC.

Rt2

is the source register. *Rt2* can be the same register as *Rt*. *Rt2* must not be PC.

Rn

contains the address in memory. *Rn* must be a different register from both *Rt* and *Rt2*. *Rn* must not be PC.

Usage

You can use SWP and SWPB to implement semaphores:

- Data from memory is loaded into *Rt*.
- The contents of *Rt2* are saved to memory.
- If *Rt2* is the same register as *Rt*, the contents of the register are swapped with the contents of the memory location.

Note

The use of SWP and SWPB is deprecated in ARMv6 and above. You can use LDREX and STREX instructions to implement more sophisticated semaphores in ARMv6 and above.

Architectures

These ARM instructions are available in all versions of the ARM architecture.

There are no Thumb SWP or SWPB instructions.

Related references

[11.48 LDREX on page 11-390.](#)

[11.8 Condition code suffixes on page 11-319.](#)

11.144 SXTAB

Sign extend Byte with Add, to extend an 8-bit value to a 32-bit value.

Syntax

SXTAB{*cond*} {*Rd*}, *Rn*, *Rm* {,*rotation*}

where:

cond

is an optional condition code.

Rd

is the destination register.

Rn

is the register holding the number to add.

Rm

is the register holding the value to extend.

rotation

is one of:

ROR #8

Value from *Rm* is rotated right 8 bits.

ROR #16

Value from *Rm* is rotated right 16 bits.

ROR #24

Value from *Rm* is rotated right 24 bits.

If *rotation* is omitted, no rotation is performed.

Operation

This instruction does the following:

1. Rotate the value from *Rm* right by 0, 8, 16 or 24 bits.
2. Extract bits[7:0] from the value obtained.
3. Sign extend to 32 bits.
4. Add the value from *Rn*.

Register restrictions

You cannot use PC for any register.

You can use SP in ARM instructions but this is deprecated in ARMv6T2 and above. You cannot use SP in Thumb instructions.

Condition flags

This instruction does not change the flags.

Architectures

This ARM instruction is available in ARMv6 and above.

This 32-bit Thumb instruction is available in ARMv6T2 and above. For the ARMv7-M architecture, it is only available in an ARMv7E-M implementation.

There is no 16-bit version of this instruction in Thumb.

Related references

[11.8 Condition code suffixes on page 11-319.](#)

11.145 SXTAB16

Sign extend two Bytes with Add, to extend two 8-bit values to two 16-bit values.

Syntax

SXTAB16{*cond*} {*Rd*}, *Rn*, *Rm* {,*rotation*}

where:

cond

is an optional condition code.

Rd

is the destination register.

Rn

is the register holding the number to add.

Rm

is the register holding the value to extend.

rotation

is one of:

ROR #8

Value from *Rm* is rotated right 8 bits.

ROR #16

Value from *Rm* is rotated right 16 bits.

ROR #24

Value from *Rm* is rotated right 24 bits.

If *rotation* is omitted, no rotation is performed.

Operation

This instruction does the following:

1. Rotate the value from *Rm* right by 0, 8, 16 or 24 bits.
2. Extract bits[23:16] and bits[7:0] from the value obtained.
3. Sign extend to 16 bits.
4. Add them to bits[31:16] and bits[15:0] respectively of *Rn* to form bits[31:16] and bits[15:0] of the result.

Register restrictions

You cannot use PC for any register.

You can use SP in ARM instructions but this is deprecated in ARMv6T2 and above. You cannot use SP in Thumb instructions.

Condition flags

This instruction does not change the flags.

Architectures

This ARM instruction is available in ARMv6 and above.

This 32-bit Thumb instruction is available in ARMv6T2 and above. For the ARMv7-M architecture, it is only available in an ARMv7E-M implementation.

There is no 16-bit version of this instruction in Thumb.

Related references

[11.8 Condition code suffixes on page 11-319.](#)

11.146 SXTAH

Sign extend Halfword with Add, to extend a 16-bit value to a 32-bit value.

Syntax

SXTAH{*cond*} {*Rd*}, *Rn*, *Rm* {,*rotation*}

where:

cond

is an optional condition code.

Rd

is the destination register.

Rn

is the register holding the number to add.

Rm

is the register holding the value to extend.

rotation

is one of:

ROR #8

Value from *Rm* is rotated right 8 bits.

ROR #16

Value from *Rm* is rotated right 16 bits.

ROR #24

Value from *Rm* is rotated right 24 bits.

If *rotation* is omitted, no rotation is performed.

Operation

This instruction does the following:

1. Rotate the value from *Rm* right by 0, 8, 16 or 24 bits.
2. Extract bits[15:0] from the value obtained.
3. Sign extend to 32 bits.
4. Add the value from *Rn*.

Register restrictions

You cannot use PC for any register.

You can use SP in ARM instructions but this is deprecated in ARMv6T2 and above. You cannot use SP in Thumb instructions.

Condition flags

This instruction does not change the flags.

Architectures

This ARM instruction is available in ARMv6 and above.

This 32-bit Thumb instruction is available in ARMv6T2 and above. For the ARMv7-M architecture, it is only available in an ARMv7E-M implementation.

There is no 16-bit version of this instruction in Thumb.

Related references

[11.8 Condition code suffixes on page 11-319.](#)

11.147 SXTB

Sign extend Byte, to extend an 8-bit value to a 32-bit value.

Syntax

SXTB{*cond*} {*Rd*}, *Rm* {,*rotation*}

where:

cond

is an optional condition code.

Rd

is the destination register.

Rm

is the register holding the value to extend.

rotation

is one of:

ROR #8

Value from *Rm* is rotated right 8 bits.

ROR #16

Value from *Rm* is rotated right 16 bits.

ROR #24

Value from *Rm* is rotated right 24 bits.

If *rotation* is omitted, no rotation is performed.

Operation

This instruction does the following:

1. Rotates the value from *Rm* right by 0, 8, 16 or 24 bits.
2. Extracts bits[7:0] from the value obtained.
3. Sign extends to 32 bits.

Register restrictions

You cannot use PC for any register.

You can use SP in ARM instructions but this is deprecated in ARMv6T2 and above. You cannot use SP in Thumb instructions.

Condition flags

This instruction does not change the flags.

16-bit instructions

The following form of this instruction is available in Thumb code, and is a 16-bit instruction:

SXTB *Rd*, *Rm*

Rd and *Rm* must both be Lo registers.

Architectures

This ARM instruction is available in ARMv6 and above.

This 32-bit Thumb instruction is available in ARMv6T2 and above. For the ARMv7-M architecture, it is only available in an ARMv7E-M implementation.

This 16-bit Thumb instruction is available in ARMv6 and above.

Related references

[11.8 Condition code suffixes on page 11-319.](#)

11.148 SXTB16

Sign extend two bytes.

Syntax

SXTB16{*cond*} {*Rd*}, *Rm* {,*rotation*}

where:

cond

is an optional condition code.

Rd

is the destination register.

Rm

is the register holding the value to extend.

rotation

is one of:

ROR #8

Value from *Rm* is rotated right 8 bits.

ROR #16

Value from *Rm* is rotated right 16 bits.

ROR #24

Value from *Rm* is rotated right 24 bits.

If *rotation* is omitted, no rotation is performed.

Operation

SXTB16 extends two 8-bit values to two 16-bit values. It does this by:

1. Rotating the value from *Rm* right by 0, 8, 16 or 24 bits.
2. Extracting bits[23:16] and bits[7:0] from the value obtained.
3. Sign extending to 16 bits each.

Register restrictions

You cannot use PC for any register.

You can use SP in ARM instructions but this is deprecated in ARMv6T2 and above. You cannot use SP in Thumb instructions.

Condition flags

This instruction does not change the flags.

Architectures

This ARM instruction is available in ARMv6 and above.

This 32-bit Thumb instruction is available in ARMv6T2 and above. For the ARMv7-M architecture, it is only available in an ARMv7E-M implementation.

There is no 16-bit version of this instruction in Thumb.

Related references

[11.8 Condition code suffixes on page 11-319.](#)

11.149 SXTB

Sign extend Halfword.

Syntax

SXTB{*cond*} {*Rd*}, *Rm* {,*rotation*}

where:

cond

is an optional condition code.

Rd

is the destination register.

Rm

is the register holding the value to extend.

rotation

is one of:

ROR #8

Value from *Rm* is rotated right 8 bits.

ROR #16

Value from *Rm* is rotated right 16 bits.

ROR #24

Value from *Rm* is rotated right 24 bits.

If *rotation* is omitted, no rotation is performed.

Operation

SXTB extends a 16-bit value to a 32-bit value. It does this by:

1. Rotating the value from *Rm* right by 0, 8, 16 or 24 bits.
2. Extracting bits[15:0] from the value obtained.
3. Sign extending to 32 bits.

Register restrictions

You cannot use PC for any register.

You can use SP in ARM instructions but this is deprecated in ARMv6T2 and above. You cannot use SP in Thumb instructions.

Condition flags

This instruction does not change the flags.

16-bit instructions

The following form of this instruction is available in Thumb code, and is a 16-bit instruction:

SXTB *Rd*, *Rm*

Rd and *Rm* must both be Lo registers.

Architectures

This ARM instruction is available in ARMv6 and above.

This 32-bit Thumb instruction is available in ARMv6T2 and above. For the ARMv7-M architecture, it is only available in an ARMv7E-M implementation.

This 16-bit Thumb instruction is available in ARMv6 and above.

Example

```
SXTH    r3, r9, r4
```

Incorrect example

```
SXTH    r9, r3, r2, ROR #12 ; rotation must be by 0, 8, 16, or 24.
```

Related references

[11.8 Condition code suffixes](#) on page 11-319.

11.150 SYS

Execute system coprocessor instruction.

Syntax

`SYS{cond} instruction{, Rn}`

where:

cond

is an optional condition code.

instruction

is the coprocessor instruction to execute.

Rn

is an operand to the instruction. For instructions that take an argument, *Rn* is compulsory. For instructions that do not take an argument, *Rn* is optional and if it is not specified, `R0` is used. *Rn* must not be PC.

Usage

You can use this pseudo-instruction to execute special coprocessor instructions such as cache, branch predictor, and TLB operations. The instructions operate by writing to special write-only coprocessor registers. The instruction names are the same as the write-only coprocessor register names and are listed in the *ARMv7-AR Architecture Reference Manual*. For example:

```
SYS ICIALLUIS ; invalidates all instruction caches Inner Shareable
               ; to Point of Unification and also flushes branch
               ; target cache.
```

Architectures

The SYS pseudo-instruction is available in ARMv7-A and ARMv7-R in ARM and 32-bit Thumb code. There is no 16-bit version of this instruction in Thumb.

Related references

[11.8 Condition code suffixes](#) on page 11-319.

11.151 TBB and TBH

Table Branch Byte and Table Branch Halfword.

Syntax

TBB [*Rn*, *Rm*]

TBH [*Rn*, *Rm*, LSL #1]

where:

Rn

is the base register. This contains the address of the table of branch lengths. *Rn* must not be SP. If PC is specified for *Rn*, the value used is the address of the instruction plus 4.

Rm

is the index register. This contains an index into the table. *Rm* must not be PC or SP.

Operation

These instructions cause a PC-relative forward branch using a table of single byte offsets (TBB) or halfword offsets (TBH). *Rn* provides a pointer to the table, and *Rm* supplies an index into the table. The branch length is twice the value of the byte (TBB) or the halfword (TBH) returned from the table. The target of the branch table must be in the same execution state.

Architectures

These 32-bit Thumb instructions are available in ARMv6T2 and above.

There are no versions of these instructions in ARM or in 16-bit Thumb encodings.

Related concepts

[6.16 Address alignment on page 6-134.](#)

11.152 TEQ

Test Equivalence.

Syntax

TEQ{*cond*} *Rn*, *Operand2*

where:

cond

is an optional condition code.

Rn

is the ARM register holding the first operand.

Operand2

is a flexible second operand.

Usage

This instruction tests the value in a register against *Operand2*. It updates the condition flags on the result, but does not place the result in any register.

The TEQ instruction performs a bitwise Exclusive OR operation on the value in *Rn* and the value of *Operand2*. This is the same as an EORS instruction, except that the result is discarded.

Use the TEQ instruction to test if two values are equal, without affecting the V or C flags (as CMP does).

TEQ is also useful for testing the sign of a value. After the comparison, the N flag is the logical Exclusive OR of the sign bits of the two operands.

Register restrictions

In this Thumb instruction, you cannot use SP or PC for *Rn* or *Operand2*.

In this ARM instruction, use of SP or PC is deprecated in ARMv6T2 and above.

For ARM instructions:

- If you use PC (R15) as *Rn*, the value used is the address of the instruction plus 8.
- You cannot use PC for any operand in any data processing instruction that has a register-controlled shift.

Condition flags

This instruction:

- Updates the N and Z flags according to the result.
- Can update the C flag during the calculation of *Operand2*.
- Does not affect the V flag.

Architectures

This ARM instruction is available in all architectures that support the ARM instruction set.

The TEQ Thumb instruction is available in ARMv6T2 and above.

Correct example

```
TEQEQ r10, r9
```

Incorrect example

```
TEQ pc, r1, ROR r0 ; PC not permitted with register
                   ; controlled shift
```

Related references

11.3 Flexible second operand (Operand2) on page 11-312.

11.8 Condition code suffixes on page 11-319.

11.153 TST

Test bits.

Syntax

TST{*cond*} *Rn*, *Operand2*

where:

cond

is an optional condition code.

Rn

is the ARM register holding the first operand.

Operand2

is a flexible second operand.

Operation

This instruction tests the value in a register against *Operand2*. It updates the condition flags on the result, but does not place the result in any register.

The TST instruction performs a bitwise AND operation on the value in *Rn* and the value of *Operand2*. This is the same as an ANDS instruction, except that the result is discarded.

Register restrictions

In this Thumb instruction, you cannot use SP or PC for *Rn* or *Operand2*.

In this ARM instruction, use of SP or PC is deprecated in ARMv6T2 and above.

For ARM instructions:

- If you use PC (R15) as *Rn*, the value used is the address of the instruction plus 8.
- You cannot use PC for any operand in any data processing instruction that has a register-controlled shift.

Condition flags

This instruction:

- Updates the N and Z flags according to the result.
- Can update the C flag during the calculation of *Operand2*.
- Does not affect the V flag.

16-bit instructions

The following form of the TST instruction is available in Thumb code, and is a 16-bit instruction:

TST *Rn*, *Rm*

Rn and *Rm* must both be Lo registers.

Architectures

This ARM instruction is available in all architectures that support the ARM instruction set.

The TST Thumb instruction is available in all architectures that support the Thumb instruction set.

Examples

```
TST    r0, #0x3F8
TSTNE  r1, r5, ASR r1
```

Related references

[11.3 Flexible second operand \(*Operand2*\) on page 11-312.](#)

[11.8 Condition code suffixes on page 11-319.](#)

11.154 UADD8

Unsigned parallel byte-wise addition.

Syntax

UADD8{*cond*} {*Rd*}, *Rn*, *Rm*

where:

cond
is an optional condition code.

Rd
is the destination register.

Rm, *Rn*
are the ARM registers holding the operands.

Operation

This instruction performs four unsigned integer additions on the corresponding bytes of the operands and writes the results into the corresponding bytes of the destination. The results are modulo 2^8 . It sets the APSR GE flags.

Register restrictions

You cannot use PC for any register.

You can use SP in ARM instructions but this is deprecated in ARMv6T2 and above. You cannot use SP in Thumb instructions.

GE flags

This instruction does not affect the N, Z, C, V, or Q flags.

It sets the GE flags in the APSR as follows:

GE[0]
for bits[7:0] of the result.
GE[1]
for bits[15:8] of the result.
GE[2]
for bits[23:16] of the result.
GE[3]
for bits[31:24] of the result.

It sets a GE flag to 1 to indicate that the corresponding result overflowed, generating a carry. This is equivalent to an ADDS instruction setting the C condition flag to 1.

You can use these flags to control a following SEL instruction.

Architectures

This ARM instruction is available in ARMv6 and above.

This 32-bit Thumb instruction is available in ARMv6T2 and above. For the ARMv7-M architecture, it is only available in an ARMv7E-M implementation.

There is no 16-bit version of this instruction in Thumb.

Related references

[11.102 SEL on page 11-464.](#)

[11.8 Condition code suffixes on page 11-319.](#)

11.155 UADD16

Unsigned parallel halfword-wise addition.

Syntax

UADD16{*cond*} {*Rd*}, *Rn*, *Rm*

where:

cond
is an optional condition code.

Rd
is the destination register.

Rm, *Rn*
are the ARM registers holding the operands.

Operation

This instruction performs two unsigned integer additions on the corresponding halfwords of the operands and writes the results into the corresponding halfwords of the destination. The results are modulo 2^{16} . It sets the APSR GE flags.

Register restrictions

You cannot use PC for any register.

You can use SP in ARM instructions but this is deprecated in ARMv6T2 and above. You cannot use SP in Thumb instructions.

GE flags

This instruction does not affect the N, Z, C, V, or Q flags.

It sets the GE flags in the APSR as follows:

GE[1:0]
for bits[15:0] of the result.

GE[3:2]
for bits[31:16] of the result.

It sets a pair of GE flags to 1 to indicate that the corresponding result overflowed, generating a carry. This is equivalent to an ADDS instruction setting the C condition flag to 1.

You can use these flags to control a following SEL instruction.

————— **Note** —————

GE[1:0] are set or cleared together, and GE[3:2] are set or cleared together.

Architectures

This ARM instruction is available in ARMv6 and above.

This 32-bit Thumb instruction is available in ARMv6T2 and above. For the ARMv7-M architecture, it is only available in an ARMv7E-M implementation.

There is no 16-bit version of this instruction in Thumb.

Related references

[11.102 SEL on page 11-464.](#)

[11.8 Condition code suffixes on page 11-319.](#)

11.156 UASX

Unsigned parallel add and subtract halfwords with exchange.

Syntax

`UASX{cond} {Rd}, Rn, Rm`

where:

cond
is an optional condition code.

Rd
is the destination register.

Rm, Rn
are the ARM registers holding the operands.

Operation

This instruction exchanges the two halfwords of the second operand, then performs an addition on the two top halfwords of the operands and a subtraction on the bottom two halfwords. It writes the results into the corresponding halfwords of the destination. The results are modulo 2^{16} . It sets the APSR GE flags.

Register restrictions

You cannot use PC for any register.

You can use SP in ARM instructions but this is deprecated in ARMv6T2 and above. You cannot use SP in Thumb instructions.

GE flags

This instruction does not affect the N, Z, C, V, or Q flags.

It sets the GE flags in the APSR as follows:

GE[1:0]
for bits[15:0] of the result.

GE[3:2]
for bits[31:16] of the result.

It sets GE[1:0] to 1 to indicate that the subtraction gave a result greater than or equal to zero, meaning a borrow did not occur. This is equivalent to a SUBS instruction setting the C condition flag to 1.

It sets GE[3:2] to 1 to indicate that the addition overflowed, generating a carry. This is equivalent to an ADDS instruction setting the C condition flag to 1.

You can use these flags to control a following SEL instruction.

————— **Note** —————

GE[1:0] are set or cleared together, and GE[3:2] are set or cleared together.

Architectures

This ARM instruction is available in ARMv6 and above.

This 32-bit Thumb instruction is available in ARMv6T2 and above. For the ARMv7-M architecture, it is only available in an ARMv7E-M implementation.

There is no 16-bit version of this instruction in Thumb.

Related references

[11.102 SEL](#) on page 11-464.

[11.8 Condition code suffixes](#) on page 11-319.

11.157 UBFX

Unsigned Bit Field Extract.

Syntax

`UBFX{cond} Rd, Rn, #Lsb, #width`

where:

cond

is an optional condition code.

Rd

is the destination register.

Rn

is the source register.

Lsb

is the bit number of the least significant bit in the bitfield, in the range 0 to 31.

width

is the width of the bitfield, in the range 1 to $(32-Lsb)$.

Operation

Copies adjacent bits from one register into the least significant bits of a second register, and zero extends to 32 bits.

Register restrictions

You cannot use PC for any register.

You can use SP in the ARM instruction but this is deprecated in ARMv6T2 and above. You cannot use SP in the Thumb instruction.

Condition flags

This instruction does not alter any flags.

Architectures

This ARM instruction is available in ARMv6T2 and above.

This 32-bit Thumb instruction is available in ARMv6T2 and above.

There is no 16-bit version of this instruction in Thumb.

Related references

[11.8 Condition code suffixes on page 11-319.](#)

11.158 UDIV

Unsigned Divide.

Syntax

UDIV{*cond*} {*Rd*}, *Rn*, *Rm*

where:

cond

is an optional condition code.

Rd

is the destination register.

Rn

is the register holding the value to be divided.

Rm

is a register holding the divisor.

Register restrictions

PC or SP cannot be used for *Rd*, *Rn*, or *Rm*.

Architectures

This 32-bit Thumb instruction is available in ARMv7-R and ARMv7-M.

This ARM instruction is optional in ARMv7-R.

This ARM and 32-bit Thumb instruction is available in ARMv7-A if Virtualization Extensions are implemented, and optional if not.

There is no 16-bit Thumb UDIV instruction.

Related references

[11.8 Condition code suffixes](#) on page 11-319.

11.159 UHADD8

Unsigned halving parallel byte-wise addition.

Syntax

UHADD8{*cond*} {*Rd*}, *Rn*, *Rm*

where:

cond
is an optional condition code.

Rd
is the destination register.

Rm, *Rn*
are the ARM registers holding the operands.

Operation

This instruction performs four unsigned integer additions on the corresponding bytes of the operands, halves the results, and writes the results into the corresponding bytes of the destination. This cannot cause overflow.

Register restrictions

You cannot use PC for any register.

You can use SP in ARM instructions but this is deprecated in ARMv6T2 and above. You cannot use SP in Thumb instructions.

Condition flags

This instruction does not affect the N, Z, C, V, Q, or GE flags.

Architectures

This ARM instruction is available in ARMv6 and above.

This 32-bit Thumb instruction is available in ARMv6T2 and above. For the ARMv7-M architecture, it is only available in an ARMv7E-M implementation.

There is no 16-bit version of this instruction in Thumb.

Related references

[11.8 Condition code suffixes on page 11-319.](#)

11.160 UHADD16

Unsigned halving parallel halfword-wise addition.

Syntax

UHADD16{*cond*} {*Rd*}, *Rn*, *Rm*

where:

cond
is an optional condition code.

Rd
is the destination register.

Rm, *Rn*
are the ARM registers holding the operands.

Operation

This instruction performs two unsigned integer additions on the corresponding halfwords of the operands, halves the results, and writes the results into the corresponding halfwords of the destination. This cannot cause overflow.

Register restrictions

You cannot use PC for any register.

You can use SP in ARM instructions but this is deprecated in ARMv6T2 and above. You cannot use SP in Thumb instructions.

Condition flags

This instruction does not affect the N, Z, C, V, Q, or GE flags.

Architectures

This ARM instruction is available in ARMv6 and above.

This 32-bit Thumb instruction is available in ARMv6T2 and above. For the ARMv7-M architecture, it is only available in an ARMv7E-M implementation.

There is no 16-bit version of this instruction in Thumb.

Related references

[11.8 Condition code suffixes on page 11-319.](#)

11.161 UHASX

Unsigned halving parallel add and subtract halfwords with exchange.

Syntax

UHASX{*cond*} {*Rd*}, *Rn*, *Rm*

where:

cond
is an optional condition code.

Rd
is the destination register.

Rm, *Rn*
are the ARM registers holding the operands.

Operation

This instruction exchanges the two halfwords of the second operand, then performs an addition on the two top halfwords of the operands and a subtraction on the bottom two halfwords. It halves the results and writes them into the corresponding halfwords of the destination. This cannot cause overflow.

Register restrictions

You cannot use PC for any register.

You can use SP in ARM instructions but this is deprecated in ARMv6T2 and above. You cannot use SP in Thumb instructions.

Condition flags

This instruction does not affect the N, Z, C, V, Q, or GE flags.

Architectures

This ARM instruction is available in ARMv6 and above.

This 32-bit Thumb instruction is available in ARMv6T2 and above. For the ARMv7-M architecture, it is only available in an ARMv7E-M implementation.

There is no 16-bit version of this instruction in Thumb.

Related references

[11.8 Condition code suffixes on page 11-319.](#)

11.162 UHSAX

Unsigned halving parallel subtract and add halfwords with exchange.

Syntax

UHSAX{*cond*} {*Rd*}, *Rn*, *Rm*

where:

cond
is an optional condition code.

Rd
is the destination register.

Rm, *Rn*
are the ARM registers holding the operands.

Operation

This instruction exchanges the two halfwords of the second operand, then performs a subtraction on the two top halfwords of the operands and an addition on the bottom two halfwords. It halves the results and writes them into the corresponding halfwords of the destination. This cannot cause overflow.

Register restrictions

You cannot use PC for any register.

You can use SP in ARM instructions but this is deprecated in ARMv6T2 and above. You cannot use SP in Thumb instructions.

Condition flags

This instruction does not affect the N, Z, C, V, Q, or GE flags.

Architectures

This ARM instruction is available in ARMv6 and above.

This 32-bit Thumb instruction is available in ARMv6T2 and above. For the ARMv7-M architecture, it is only available in an ARMv7E-M implementation.

There is no 16-bit version of this instruction in Thumb.

Related references

[11.8 Condition code suffixes on page 11-319.](#)

11.163 UHSUB8

Unsigned halving parallel byte-wise subtraction.

Syntax

UHSUB8{*cond*} {*Rd*}, *Rn*, *Rm*

where:

cond
is an optional condition code.

Rd
is the destination register.

Rm, *Rn*
are the ARM registers holding the operands.

Operation

This instruction subtracts each byte of the second operand from the corresponding byte of the first operand, halves the results, and writes the results into the corresponding bytes of the destination. This cannot cause overflow.

Register restrictions

You cannot use PC for any register.

You can use SP in ARM instructions but this is deprecated in ARMv6T2 and above. You cannot use SP in Thumb instructions.

Condition flags

This instruction does not affect the N, Z, C, V, Q, or GE flags.

Architectures

This ARM instruction is available in ARMv6 and above.

This 32-bit Thumb instruction is available in ARMv6T2 and above. For the ARMv7-M architecture, it is only available in an ARMv7E-M implementation.

There is no 16-bit version of this instruction in Thumb.

Related references

[11.8 Condition code suffixes on page 11-319.](#)

11.164 UHSUB16

Unsigned halving parallel halfword-wise subtraction.

Syntax

UHSUB16{*cond*} {*Rd*}, *Rn*, *Rm*

where:

cond
is an optional condition code.

Rd
is the destination register.

Rm, *Rn*
are the ARM registers holding the operands.

Operation

This instruction subtracts each halfword of the second operand from the corresponding halfword of the first operand, halves the results, and writes the results into the corresponding halfwords of the destination. This cannot cause overflow.

Register restrictions

You cannot use PC for any register.

You can use SP in ARM instructions but this is deprecated in ARMv6T2 and above. You cannot use SP in Thumb instructions.

Condition flags

This instruction does not affect the N, Z, C, V, Q, or GE flags.

Architectures

This ARM instruction is available in ARMv6 and above.

This 32-bit Thumb instruction is available in ARMv6T2 and above. For the ARMv7-M architecture, it is only available in an ARMv7E-M implementation.

There is no 16-bit version of this instruction in Thumb.

Related references

[11.8 Condition code suffixes on page 11-319.](#)

11.165 UMAAL

Unsigned Multiply Accumulate Accumulate Long.

Syntax

UMAAL{*cond*} *RdLo*, *RdHi*, *Rn*, *Rm*

where:

cond

is an optional condition code.

RdLo, *RdHi*

are the destination registers for the 64-bit result. They also hold the two 32-bit accumulate operands. *RdLo* and *RdHi* must be different registers.

Rn, *Rm*

are the registers holding the multiply operands.

Operation

The UMAAL instruction multiplies the 32-bit values in *Rn* and *Rm*, adds the two 32-bit values in *RdHi* and *RdLo*, and stores the 64-bit result to *RdLo*, *RdHi*.

Register restrictions

You cannot use PC for any register.

You can use SP in ARM instructions but this is deprecated in ARMv6T2 and above. You cannot use SP in Thumb instructions.

Condition flags

This instruction does not change the flags.

Architectures

This ARM instruction is available in ARMv6 and above.

This 32-bit Thumb instruction is available in ARMv6T2 and above. For the ARMv7-M architecture, it is only available in an ARMv7E-M implementation.

There is no 16-bit version of this instruction in Thumb.

Examples

UMAAL	r8, r9, r2, r3
UMAALGE	r2, r0, r5, r3

Related references

[11.8 Condition code suffixes on page 11-319.](#)

11.166 UMLAL

Unsigned Long Multiply, with optional Accumulate, with 32-bit operands and 64-bit result and accumulator.

Syntax

UMLAL{S}{*cond*} *RdLo*, *RdHi*, *Rn*, *Rm*

where:

S

is an optional suffix available in ARM state only. If S is specified, the condition flags are updated based on the result of the operation.

cond

is an optional condition code.

RdLo, *RdHi*

are the destination registers. They also hold the accumulating value. *RdLo* and *RdHi* must be different registers.

Rn, *Rm*

are ARM registers holding the operands.

Operation

The UMLAL instruction interprets the values from *Rn* and *Rm* as unsigned integers. It multiplies these integers, and adds the 64-bit result to the 64-bit unsigned integer contained in *RdHi* and *RdLo*.

Register restrictions

Rn must be different from *RdLo* and *RdHi* in architectures before ARMv6.

You cannot use PC for any register.

You can use SP in ARM instructions but this is deprecated in ARMv6T2 and above. You cannot use SP in Thumb instructions.

Condition flags

If S is specified, this instruction:

- Updates the N and Z flags according to the result.
- Does not affect the C or V flags.

Architectures

This ARM instruction is available in all versions of the ARM architecture.

This 32-bit Thumb instruction is available in ARMv6T2 and above.

There is no 16-bit version of this instruction in Thumb.

Example

```
UMLALS    r4, r5, r3, r8
```

Related references

[11.8 Condition code suffixes on page 11-319.](#)

11.167 UMULL

Unsigned Long Multiply, with 32-bit operands, and 64-bit result.

Syntax

UMULL{S}{*cond*} *RdLo*, *RdHi*, *Rn*, *Rm*

where:

S

is an optional suffix available in ARM state only. If S is specified, the condition flags are updated based on the result of the operation.

cond

is an optional condition code.

RdLo, *RdHi*

are the destination registers. *RdLo* and *RdHi* must be different registers.

Rn, *Rm*

are ARM registers holding the operands.

Operation

The UMULL instruction interprets the values from *Rn* and *Rm* as unsigned integers. It multiplies these integers and places the least significant 32 bits of the result in *RdLo*, and the most significant 32 bits of the result in *RdHi*.

Register restrictions

Rn must be different from *RdLo* and *RdHi* in architectures before ARMv6.

You cannot use PC for any register.

You can use SP in ARM instructions but this is deprecated in ARMv6T2 and above. You cannot use SP in Thumb instructions.

Condition flags

If S is specified, this instruction:

- Updates the N and Z flags according to the result.
- Does not affect the C or V flags.

Architectures

This ARM instruction is available in all versions of the ARM architecture.

This 32-bit Thumb instruction is available in ARMv6T2 and above.

There is no 16-bit version of this instruction in Thumb.

Example

```
UMULL    r0, r4, r5, r6
```

Related references

[11.8 Condition code suffixes on page 11-319.](#)

11.168 UND pseudo-instruction

Generate an architecturally undefined instruction.

Syntax

UND{*cond*}{*.w*} {#*expr*}

where:

cond

is an optional condition code.

.w

is an optional instruction width specifier.

expr

evaluates to a numeric value. The following table shows the range and encoding of *expr* in the instruction, where Y shows the locations of the bits that encode for *expr* and V is the 4 bits that encode for the condition code.

If *expr* is omitted, the value 0 is used.

Table 11-18 Range and encoding of *expr*

Instruction	Encoding	Number of bits for <i>expr</i>	Range
ARM	0xV7FYYYFY	16	0-65535
Thumb 32-bit encoding	0xF7FYAYFY	12	0-4095
Thumb16-bit encoding	0xDEYY	8	0-255

Usage

An attempt to execute an undefined instruction causes the Undefined instruction exception. Architecturally undefined instructions are expected to remain undefined.

UND in Thumb code

You can use the *.w* width specifier to force UND to generate a 32-bit instruction in Thumb code on ARMv6T2 and above processors. UND *.w* always generates a 32-bit instruction, even if *expr* is in the range 0-255.

Disassembly

The encodings that this pseudo-instruction produces disassemble to DCI.

Related references

[11.8 Condition code suffixes on page 11-319.](#)

11.169 UQADD8

Unsigned saturating parallel byte-wise addition.

Syntax

UQADD8{*cond*} {*Rd*}, *Rn*, *Rm*

where:

cond
is an optional condition code.

Rd
is the destination register.

Rm, *Rn*
are the ARM registers holding the operands.

Operation

This instruction performs four unsigned integer additions on the corresponding bytes of the operands and writes the results into the corresponding bytes of the destination. It saturates the results to the unsigned range $0 \leq x \leq 2^8 - 1$. The Q flag is not affected even if this operation saturates.

Register restrictions

You cannot use PC for any register.

You can use SP in ARM instructions but this is deprecated in ARMv6T2 and above. You cannot use SP in Thumb instructions.

Condition flags

This instruction does not affect the N, Z, C, V, Q, or GE flags.

Architectures

This ARM instruction is available in ARMv6 and above.

This 32-bit Thumb instruction is available in ARMv6T2 and above. For the ARMv7-M architecture, it is only available in an ARMv7E-M implementation.

There is no 16-bit version of this instruction in Thumb.

Related references

[11.8 Condition code suffixes on page 11-319.](#)

11.170 UQADD16

Unsigned saturating parallel halfword-wise addition.

Syntax

UQADD16{*cond*} {*Rd*}, *Rn*, *Rm*

where:

cond
is an optional condition code.

Rd
is the destination register.

Rm, *Rn*
are the ARM registers holding the operands.

Operation

This instruction performs two unsigned integer additions on the corresponding halfwords of the operands and writes the results into the corresponding halfwords of the destination. It saturates the results to the unsigned range $0 \leq x \leq 2^{16} - 1$. The Q flag is not affected even if this operation saturates.

Register restrictions

You cannot use PC for any register.

You can use SP in ARM instructions but this is deprecated in ARMv6T2 and above. You cannot use SP in Thumb instructions.

Condition flags

This instruction does not affect the N, Z, C, V, Q, or GE flags.

Architectures

This ARM instruction is available in ARMv6 and above.

This 32-bit Thumb instruction is available in ARMv6T2 and above. For the ARMv7-M architecture, it is only available in an ARMv7E-M implementation.

There is no 16-bit version of this instruction in Thumb.

Related references

[11.8 Condition code suffixes on page 11-319.](#)

11.171 UQASX

Unsigned saturating parallel add and subtract halfwords with exchange.

Syntax

UQASX{*cond*} {*Rd*}, *Rn*, *Rm*

where:

cond
is an optional condition code.

Rd
is the destination register.

Rm, *Rn*
are the ARM registers holding the operands.

Operation

This instruction exchanges the two halfwords of the second operand, then performs an addition on the two top halfwords of the operands and a subtraction on the bottom two halfwords. It writes the results into the corresponding halfwords of the destination. It saturates the results to the unsigned range $0 \leq x \leq 2^{16} - 1$. The Q flag is not affected even if this operation saturates.

Register restrictions

You cannot use PC for any register.

You can use SP in ARM instructions but this is deprecated in ARMv6T2 and above. You cannot use SP in Thumb instructions.

Condition flags

This instruction does not affect the N, Z, C, V, Q, or GE flags.

Architectures

This ARM instruction is available in ARMv6 and above.

This 32-bit Thumb instruction is available in ARMv6T2 and above. For the ARMv7-M architecture, it is only available in an ARMv7E-M implementation.

There is no 16-bit version of this instruction in Thumb.

Related references

[11.8 Condition code suffixes on page 11-319.](#)

11.172 UQSAX

Unsigned saturating parallel subtract and add halfwords with exchange.

Syntax

UQSAX{*cond*} {*Rd*}, *Rn*, *Rm*

where:

cond
is an optional condition code.

Rd
is the destination register.

Rm, *Rn*
are the ARM registers holding the operands.

Operation

This instruction exchanges the two halfwords of the second operand, then performs a subtraction on the two top halfwords of the operands and an addition on the bottom two halfwords. It writes the results into the corresponding halfwords of the destination. It saturates the results to the unsigned range $0 \leq x \leq 2^{16} - 1$. The Q flag is not affected even if this operation saturates.

Register restrictions

You cannot use PC for any register.

You can use SP in ARM instructions but this is deprecated in ARMv6T2 and above. You cannot use SP in Thumb instructions.

Condition flags

This instruction does not affect the N, Z, C, V, Q, or GE flags.

Architectures

This ARM instruction is available in ARMv6 and above.

This 32-bit Thumb instruction is available in ARMv6T2 and above. For the ARMv7-M architecture, it is only available in an ARMv7E-M implementation.

There is no 16-bit version of this instruction in Thumb.

Related references

[11.8 Condition code suffixes on page 11-319.](#)

11.173 UQSUB8

Unsigned saturating parallel byte-wise subtraction.

Syntax

UQSUB8{*cond*} {*Rd*}, *Rn*, *Rm*

where:

cond
is an optional condition code.

Rd
is the destination register.

Rm, *Rn*
are the ARM registers holding the operands.

Operation

This instruction subtracts each byte of the second operand from the corresponding byte of the first operand and writes the results into the corresponding bytes of the destination. It saturates the results to the unsigned range $0 \leq x \leq 2^8 - 1$. The Q flag is not affected even if this operation saturates.

Register restrictions

You cannot use PC for any register.

You can use SP in ARM instructions but this is deprecated in ARMv6T2 and above. You cannot use SP in Thumb instructions.

Condition flags

This instruction does not affect the N, Z, C, V, Q, or GE flags.

Architectures

This ARM instruction is available in ARMv6 and above.

This 32-bit Thumb instruction is available in ARMv6T2 and above. For the ARMv7-M architecture, it is only available in an ARMv7E-M implementation.

There is no 16-bit version of this instruction in Thumb.

Related references

[11.8 Condition code suffixes on page 11-319.](#)

11.174 UQSUB16

Unsigned saturating parallel halfword-wise subtraction.

Syntax

UQSUB16{*cond*} {*Rd*}, *Rn*, *Rm*

where:

cond
is an optional condition code.

Rd
is the destination register.

Rm, *Rn*
are the ARM registers holding the operands.

Operation

This instruction subtracts each halfword of the second operand from the corresponding halfword of the first operand and writes the results into the corresponding halfwords of the destination. It saturates the results to the unsigned range $0 \leq x \leq 2^{16} - 1$. The Q flag is not affected even if this operation saturates.

Register restrictions

You cannot use PC for any register.

You can use SP in ARM instructions but this is deprecated in ARMv6T2 and above. You cannot use SP in Thumb instructions.

Condition flags

This instruction does not affect the N, Z, C, V, Q, or GE flags.

Architectures

This ARM instruction is available in ARMv6 and above.

This 32-bit Thumb instruction is available in ARMv6T2 and above. For the ARMv7-M architecture, it is only available in an ARMv7E-M implementation.

There is no 16-bit version of this instruction in Thumb.

Related references

[11.8 Condition code suffixes on page 11-319.](#)

11.175 USAD8

Unsigned Sum of Absolute Differences.

Syntax

USAD8{*cond*} {*Rd*}, *Rn*, *Rm*

where:

cond

is an optional condition code.

Rd

is the destination register.

Rn

is the register holding the first operand.

Rm

is the register holding the second operand.

Operation

The USAD8 instruction finds the four differences between the unsigned values in corresponding bytes of *Rn* and *Rm*. It adds the absolute values of the four differences, and saves the result to *Rd*.

Register restrictions

You cannot use PC for any register.

You can use SP in ARM instructions but this is deprecated in ARMv6T2 and above. You cannot use SP in Thumb instructions.

Condition flags

This instruction does not alter any flags.

Architectures

This ARM instruction is available in ARMv6 and above.

This 32-bit Thumb instruction is available in ARMv6T2 and above. For the ARMv7-M architecture, it is only available in an ARMv7E-M implementation.

There is no 16-bit version of this instruction in Thumb.

Example

```
USAD8    r2, r4, r6
```

Related references

[11.8 Condition code suffixes](#) on page 11-319.

11.176 USADA8

Unsigned Sum of Absolute Differences and Accumulate.

Syntax

USADA8{*cond*} *Rd*, *Rn*, *Rm*, *Ra*

where:

cond

is an optional condition code.

Rd

is the destination register.

Rn

is the register holding the first operand.

Rm

is the register holding the second operand.

Ra

is the register holding the accumulate operand.

Operation

The USADA8 instruction adds the absolute values of the four differences to the value in *Ra*, and saves the result to *Rd*.

Register restrictions

You cannot use PC for any register.

You can use SP in ARM instructions but this is deprecated in ARMv6T2 and above. You cannot use SP in Thumb instructions.

Condition flags

This instruction does not alter any flags.

Architectures

This ARM instruction is available in ARMv6 and above.

This 32-bit Thumb instruction is available in ARMv6T2 and above. For the ARMv7-M architecture, it is only available in an ARMv7E-M implementation.

There is no 16-bit version of this instruction in Thumb.

Correct examples

USADA8	r0, r3, r5, r2
USADA8VS	r0, r4, r0, r1

Incorrect examples

USADA8	r2, r4, r6	; USADA8 requires four registers
USADA16	r0, r4, r0, r1	; no such instruction

Related references

[11.8 Condition code suffixes on page 11-319.](#)

11.177 USAT

Unsigned Saturate to any bit position, with optional shift before saturating.

Syntax

USAT{*cond*} *Rd*, #*sat*, *Rm*{, *shift*}

where:

cond

is an optional condition code.

Rd

is the destination register.

sat

specifies the bit position to saturate to, in the range 0 to 31.

Rm

is the register containing the operand.

shift

is an optional shift. It must be one of the following:

ASR #*n*

where *n* is in the range 1-32 (ARM) or 1-31 (Thumb).

LSL #*n*

where *n* is in the range 0-31.

Operation

The USAT instruction applies the specified shift to a signed value, then saturates to the unsigned range $0 \leq x \leq 2^{\text{sat}} - 1$.

Register restrictions

You cannot use PC for any register.

You can use SP in ARM instructions but this is deprecated in ARMv6T2 and above. You cannot use SP in Thumb instructions.

Q flag

If saturation occurs, this instruction sets the Q flag. To read the state of the Q flag, use an MRS instruction.

Architectures

This ARM instruction is available in ARMv6 and above.

This 32-bit Thumb instruction is available in ARMv6T2 and above.

There is no 16-bit version of this instruction in Thumb.

Example

```
USATNE r0, #7, r5
```

Related references

[11.130 SSAT16 on page 11-495.](#)

[11.63 MRS \(PSR to general-purpose register\) on page 11-410.](#)

[11.8 Condition code suffixes on page 11-319.](#)

11.178 USAT16

Parallel halfword Saturate.

Syntax

USAT16{*cond*} *Rd*, #*sat*, *Rn*

where:

cond

is an optional condition code.

Rd

is the destination register.

sat

specifies the bit position to saturate to, in the range 0 to 15.

Rn

is the register holding the operand.

Operation

Halfword-wise unsigned saturation to any bit position.

The USAT16 instruction saturates each signed halfword to the unsigned range $0 \leq x \leq 2^{\text{sat}} - 1$.

Register restrictions

You cannot use PC for any register.

You can use SP in ARM instructions but this is deprecated in ARMv6T2 and above. You cannot use SP in Thumb instructions.

Q flag

If saturation occurs on either halfword, this instruction sets the Q flag. To read the state of the Q flag, use an MRS instruction.

Architectures

This ARM instruction is available in ARMv6 and above.

This 32-bit Thumb instruction is available in ARMv6T2 and above. For the ARMv7-M architecture, it is only available in an ARMv7E-M implementation.

There is no 16-bit version of this instruction in Thumb.

Example

```
USAT16 r0, #7, r5
```

Related references

[11.63 MRS \(PSR to general-purpose register\)](#) on page 11-410.

[11.8 Condition code suffixes](#) on page 11-319.

11.179 USAX

Unsigned parallel subtract and add halfwords with exchange.

Syntax

USAX{*cond*} {*Rd*}, *Rn*, *Rm*

where:

cond
is an optional condition code.

Rd
is the destination register.

Rm, *Rn*
are the ARM registers holding the operands.

Operation

This instruction exchanges the two halfwords of the second operand, then performs a subtraction on the two top halfwords of the operands and an addition on the bottom two halfwords. It writes the results into the corresponding halfwords of the destination. The results are modulo 2^{16} . It sets the APSR GE flags.

Register restrictions

You cannot use PC for any register.

You can use SP in ARM instructions but this is deprecated in ARMv6T2 and above. You cannot use SP in Thumb instructions.

GE flags

This instruction does not affect the N, Z, C, V, or Q flags.

It sets the GE flags in the APSR as follows:

GE[1:0]
for bits[15:0] of the result.

GE[3:2]
for bits[31:16] of the result.

It sets GE[1:0] to 1 to indicate that the addition overflowed, generating a carry. This is equivalent to an ADDS instruction setting the C condition flag to 1.

It sets GE[3:2] to 1 to indicate that the subtraction gave a result greater than or equal to zero, meaning a borrow did not occur. This is equivalent to a SUBS instruction setting the C condition flag to 1.

You can use these flags to control a following SEL instruction.

————— **Note** —————

GE[1:0] are set or cleared together, and GE[3:2] are set or cleared together.

Architectures

This ARM instruction is available in ARMv6 and above.

This 32-bit Thumb instruction is available in ARMv6T2 and above. For the ARMv7-M architecture, it is only available in an ARMv7E-M implementation.

There is no 16-bit version of this instruction in Thumb.

Related references

[11.102 SEL](#) on page 11-464.

[11.8 Condition code suffixes](#) on page 11-319.

11.180 USUB8

Unsigned parallel byte-wise subtraction.

Syntax

USUB8{*cond*} {*Rd*}, *Rn*, *Rm*

where:

cond
is an optional condition code.

Rd
is the destination register.

Rm, *Rn*
are the ARM registers holding the operands.

Operation

This instruction subtracts each byte of the second operand from the corresponding byte of the first operand and writes the results into the corresponding bytes of the destination. The results are modulo 2^8 . It sets the APSR GE flags.

Register restrictions

You cannot use PC for any register.

You can use SP in ARM instructions but this is deprecated in ARMv6T2 and above. You cannot use SP in Thumb instructions.

GE flags

This instruction does not affect the N, Z, C, V, or Q flags.

It sets the GE flags in the APSR as follows:

GE[0]
for bits[7:0] of the result.

GE[1]
for bits[15:8] of the result.

GE[2]
for bits[23:16] of the result.

GE[3]
for bits[31:24] of the result.

It sets a GE flag to 1 to indicate that the corresponding result is greater than or equal to zero, meaning a borrow did not occur. This is equivalent to a SUBS instruction setting the C condition flag to 1.

You can use these flags to control a following SEL instruction.

Architectures

This ARM instruction is available in ARMv6 and above.

This 32-bit Thumb instruction is available in ARMv6T2 and above. For the ARMv7-M architecture, it is only available in an ARMv7E-M implementation.

There is no 16-bit version of this instruction in Thumb.

Related references

[11.102 SEL on page 11-464.](#)

[11.8 Condition code suffixes on page 11-319.](#)

11.181 USUB16

Unsigned parallel halfword-wise subtraction.

Syntax

USUB16{*cond*} {*Rd*}, *Rn*, *Rm*

where:

cond

is an optional condition code.

Rd

is the destination register.

Rm, *Rn*

are the ARM registers holding the operands.

Operation

This instruction subtracts each halfword of the second operand from the corresponding halfword of the first operand and writes the results into the corresponding halfwords of the destination. The results are modulo 2^{16} . It sets the APSR GE flags.

Register restrictions

You cannot use PC for any register.

You can use SP in ARM instructions but this is deprecated in ARMv6T2 and above. You cannot use SP in Thumb instructions.

Condition flags

This instruction does not affect the N, Z, C, V, or Q flags.

It sets the GE flags in the APSR as follows:

GE[1:0]

for bits[15:0] of the result.

GE[3:2]

for bits[31:16] of the result.

It sets a pair of GE flags to 1 to indicate that the corresponding result is greater than or equal to zero, meaning a borrow did not occur. This is equivalent to a SUBS instruction setting the C condition flag to 1.

You can use these flags to control a following SEL instruction.

————— **Note** —————

GE[1:0] are set or cleared together, and GE[3:2] are set or cleared together.

Architectures

This ARM instruction is available in ARMv6 and above.

This 32-bit Thumb instruction is available in ARMv6T2 and above. For the ARMv7-M architecture, it is only available in an ARMv7E-M implementation.

There is no 16-bit version of this instruction in Thumb.

Related references

[11.102 SEL on page 11-464.](#)

[11.8 Condition code suffixes on page 11-319.](#)

11.182 UXTAB

Zero extend Byte and Add.

Syntax

UXTAB{*cond*} {*Rd*}, *Rn*, *Rm* {,*rotation*}

where:

cond

is an optional condition code.

Rd

is the destination register.

Rn

is the register holding the number to add.

Rm

is the register holding the value to extend.

rotation

is one of:

ROR #8

Value from *Rm* is rotated right 8 bits.

ROR #16

Value from *Rm* is rotated right 16 bits.

ROR #24

Value from *Rm* is rotated right 24 bits.

If *rotation* is omitted, no rotation is performed.

Operation

UXTAB extends an 8-bit value to a 32-bit value. It does this by:

1. Rotating the value from *Rm* right by 0, 8, 16 or 24 bits.
2. Extracting bits[7:0] from the value obtained.
3. Zero extending to 32 bits.
4. Adding the value from *Rn*.

Register restrictions

You cannot use PC for any register.

You can use SP in ARM instructions but this is deprecated in ARMv6T2 and above. You cannot use SP in Thumb instructions.

Condition flags

This instruction does not change the flags.

Architectures

This ARM instruction is available in ARMv6 and above.

This 32-bit Thumb instruction is available in ARMv6T2 and above. For the ARMv7-M architecture, it are only available in an ARMv7E-M implementation.

There is no 16-bit version of this instruction in Thumb.

Related references

[11.8 Condition code suffixes on page 11-319.](#)

11.183 UXTAB16

Zero extend two Bytes and Add.

Syntax

UXTAB16{*cond*} {*Rd*}, *Rn*, *Rm* {,*rotation*}

where:

cond

is an optional condition code.

Rd

is the destination register.

Rn

is the register holding the number to add.

Rm

is the register holding the value to extend.

rotation

is one of:

ROR #8

Value from *Rm* is rotated right 8 bits.

ROR #16

Value from *Rm* is rotated right 16 bits.

ROR #24

Value from *Rm* is rotated right 24 bits.

If *rotation* is omitted, no rotation is performed.

Operation

UXTAB16 extends two 8-bit values to two 16-bit values. It does this by:

1. Rotating the value from *Rm* right by 0, 8, 16 or 24 bits.
2. Extracting bits[23:16] and bits[7:0] from the value obtained.
3. Zero extending them to 16 bits.
4. Adding them to bits[31:16] and bits[15:0] respectively of *Rn* to form bits[31:16] and bits[15:0] of the result.

Register restrictions

You cannot use PC for any register.

You can use SP in ARM instructions but this is deprecated in ARMv6T2 and above. You cannot use SP in Thumb instructions.

Condition flags

This instruction does not change the flags.

Architectures

This ARM instruction is available in ARMv6 and above.

This 32-bit Thumb instruction is available in ARMv6T2 and above. For the ARMv7-M architecture, it is only available in an ARMv7E-M implementation.

There is no 16-bit version of this instruction in Thumb.

Example

```
UXTAB16EQ    r0, r0, r4, ROR #16
```

Related references

[11.8 Condition code suffixes](#) on page 11-319.

11.184 UXTAH

Zero extend Halfword and Add.

Syntax

UXTAH{*cond*} {*Rd*}, *Rn*, *Rm* {,*rotation*}

where:

cond

is an optional condition code.

Rd

is the destination register.

Rn

is the register holding the number to add.

Rm

is the register holding the value to extend.

rotation

is one of:

ROR #8

Value from *Rm* is rotated right 8 bits.

ROR #16

Value from *Rm* is rotated right 16 bits.

ROR #24

Value from *Rm* is rotated right 24 bits.

If *rotation* is omitted, no rotation is performed.

Operation

UXTAH extends a 16-bit value to a 32-bit value. It does this by:

1. Rotating the value from *Rm* right by 0, 8, 16 or 24 bits.
2. Extracting bits[15:0] from the value obtained.
3. Zero extending to 32 bits.
4. Adding the value from *Rn*.

Register restrictions

You cannot use PC for any register.

You can use SP in ARM instructions but this is deprecated in ARMv6T2 and above. You cannot use SP in Thumb instructions.

Condition flags

This instruction does not change the flags.

Architectures

This ARM instruction is available in ARMv6 and above.

This 32-bit Thumb instruction is available in ARMv6T2 and above. For the ARMv7-M architecture, it is only available in an ARMv7E-M implementation.

There is no 16-bit version of this instruction in Thumb.

Related references

[11.8 Condition code suffixes on page 11-319.](#)

11.185 UXTB

Zero extend Byte.

Syntax

UXTB{*cond*} {*Rd*}, *Rm* {,*rotation*}

where:

cond

is an optional condition code.

Rd

is the destination register.

Rm

is the register holding the value to extend.

rotation

is one of:

ROR #8

Value from *Rm* is rotated right 8 bits.

ROR #16

Value from *Rm* is rotated right 16 bits.

ROR #24

Value from *Rm* is rotated right 24 bits.

If *rotation* is omitted, no rotation is performed.

Operation

UXTB extends an 8-bit value to a 32-bit value. It does this by:

1. Rotating the value from *Rm* right by 0, 8, 16, or 24 bits.
2. Extracting bits[7:0] from the value obtained.
3. Zero extending to 32 bits.

Register restrictions

You cannot use PC for any register.

You can use SP in ARM instructions but this is deprecated in ARMv6T2 and above. You cannot use SP in Thumb instructions.

Condition flags

This instruction does not change the flags.

16-bit instruction

The following form of this instruction is available in Thumb code, and is a 16-bit instruction:

UXTB *Rd*, *Rm*

Rd and *Rm* must both be Lo registers.

Architectures

This ARM instruction is available in ARMv6 and above.

This 32-bit Thumb instruction is available in ARMv6T2 and above. For the ARMv7-M architecture, it is only available in an ARMv7E-M implementation.

This 16-bit Thumb instruction is available in ARMv6 and above.

Related references

[11.8 Condition code suffixes on page 11-319.](#)

11.186 UXTB16

Zero extend two Bytes.

Syntax

UXTB16{*cond*} {*Rd*}, *Rm* {,*rotation*}

where:

cond

is an optional condition code.

Rd

is the destination register.

Rm

is the register holding the value to extend.

rotation

is one of:

ROR #8

Value from *Rm* is rotated right 8 bits.

ROR #16

Value from *Rm* is rotated right 16 bits.

ROR #24

Value from *Rm* is rotated right 24 bits.

If *rotation* is omitted, no rotation is performed.

Operation

UXTB16 extends two 8-bit values to two 16-bit values. It does this by:

1. Rotating the value from *Rm* right by 0, 8, 16 or 24 bits.
2. Extracting bits[23:16] and bits[7:0] from the value obtained.
3. Zero extending each to 16 bits.

Register restrictions

You cannot use PC for any register.

You can use SP in ARM instructions but this is deprecated in ARMv6T2 and above. You cannot use SP in Thumb instructions.

Condition flags

This instruction does not change the flags.

Architectures

This ARM instruction is available in ARMv6 and above.

This 32-bit Thumb instruction is available in ARMv6T2 and above. For the ARMv7-M architecture, it is only available in an ARMv7E-M implementation.

There is no 16-bit version of this instruction in Thumb.

Related references

[11.8 Condition code suffixes on page 11-319.](#)

11.187 UXTH

Zero extend Halfword.

Syntax

UXTH{*cond*} {*Rd*}, *Rm* {,*rotation*}

where:

cond

is an optional condition code.

Rd

is the destination register.

Rm

is the register holding the value to extend.

rotation

is one of:

ROR #8

Value from *Rm* is rotated right 8 bits.

ROR #16

Value from *Rm* is rotated right 16 bits.

ROR #24

Value from *Rm* is rotated right 24 bits.

If *rotation* is omitted, no rotation is performed.

Operation

UXTH extends a 16-bit value to a 32-bit value. It does this by:

1. Rotating the value from *Rm* right by 0, 8, 16, or 24 bits.
2. Extracting bits[15:0] from the value obtained.
3. Zero extending to 32 bits.

Register restrictions

You cannot use PC for any register.

You can use SP in ARM instructions but this is deprecated in ARMv6T2 and above. You cannot use SP in Thumb instructions.

Condition flags

This instruction does not change the flags.

16-bit instructions

The following form of this instruction is available in Thumb code, and is a 16-bit instruction:

UXTH *Rd*, *Rm*

Rd and *Rm* must both be Lo registers.

Architectures

This ARM instruction is available in ARMv6 and above.

This 32-bit Thumb instruction is available in ARMv6T2 and above. For the ARMv7-M architecture, it is only available in an ARMv7E-M implementation.

This 16-bit Thumb instruction is available in ARMv6 and above.

Related references

[11.8 Condition code suffixes on page 11-319.](#)

11.188 WFE

Wait For Event.

Syntax

WFE{*cond*}

where:

cond

is an optional condition code.

Operation

This is a hint instruction. It is optional whether this instruction is implemented or not. If this instruction is not implemented, it executes as a NOP. The assembler produces a diagnostic message if the instruction executes as a NOP on the target.

WFE executes as a NOP instruction in ARMv6T2.

If the Event Register is not set, WFE suspends execution until one of the following events occurs:

- An IRQ interrupt, unless masked by the CPSR I-bit.
- An FIQ interrupt, unless masked by the CPSR F-bit.
- An Imprecise Data abort, unless masked by the CPSR A-bit.
- A Debug Entry request, if Debug is enabled.
- An Event signaled by another processor using the SEV instruction.

If the Event Register is set, WFE clears it and returns immediately.

If WFE is implemented, SEV must also be implemented.

Architectures

This ARM instruction is available in ARMv6K and above.

This 32-bit Thumb instruction is available in ARMv6T2 and above.

This 16-bit Thumb instruction is available in ARMv6T2 and above.

Related references

[11.70 NOP](#) on page 11-421.

[11.8 Condition code suffixes](#) on page 11-319.

[11.104 SEV](#) on page 11-467.

[11.189 WFI](#) on page 11-569.

11.189 WFI

Wait for Interrupt.

Syntax

WFI{*cond*}

where:

cond

is an optional condition code.

Operation

This is a hint instruction. It is optional whether this instruction is implemented or not. If this instruction is not implemented, it executes as a NOP. The assembler produces a diagnostic message if the instruction executes as a NOP on the target.

WFI executes as a NOP instruction in ARMv6T2.

WFI suspends execution until one of the following events occurs:

- An IRQ interrupt, regardless of the CPSR I-bit.
- An FIQ interrupt, regardless of the CPSR F-bit.
- An Imprecise Data abort, unless masked by the CPSR A-bit.
- A Debug Entry request, regardless of whether Debug is enabled.

Architectures

This ARM instruction is available in ARMv6K and above.

This 32-bit Thumb instruction is available in ARMv6T2 and above.

This 16-bit Thumb instruction is available in ARMv6T2 and above.

Related references

[11.70 NOP on page 11-421.](#)

[11.8 Condition code suffixes on page 11-319.](#)

[11.188 WFE on page 11-568.](#)

11.190 YIELD

Yield.

Syntax

YIELD{*cond*}

where:

cond

is an optional condition code.

Operation

This is a hint instruction. It is optional whether this instruction is implemented or not. If this instruction is not implemented, it executes as a NOP. The assembler produces a diagnostic message if the instruction executes as a NOP on the target.

YIELD executes as a NOP instruction in ARMv6T2.

YIELD indicates to the hardware that the current thread is performing a task, for example a spinlock, that can be swapped out. Hardware can use this hint to suspend and resume threads in a multithreading system.

Architectures

This ARM instruction is available in ARMv6K and above.

This 32-bit Thumb instruction is available in ARMv6T2 and above.

This 16-bit Thumb instruction is available in ARMv6T2 and above.

Related references

[11.70 NOP on page 11-421.](#)

[11.8 Condition code suffixes on page 11-319.](#)

Chapter 12

NEON Instructions

Describes the assembly programming of NEON technology.

It contains the following sections:

- [12.1 Summary of NEON instructions](#) on page 12-574.
- [12.2 Summary of shared NEON and VFP instructions](#) on page 12-578.
- [12.3 Interleaving provided by load and store element and structure instructions](#) on page 12-579.
- [12.4 Alignment restrictions in load and store element and structure instructions](#) on page 12-580.
- [12.5 VABA and VABAL](#) on page 12-581.
- [12.6 VABD and VABDL](#) on page 12-582.
- [12.7 VABS](#) on page 12-583.
- [12.8 VACLE, VACLT, VACGE and VACGT](#) on page 12-584.
- [12.9 VADD](#) on page 12-585.
- [12.10 VADDHN](#) on page 12-586.
- [12.11 VADDL and VADDW](#) on page 12-587.
- [12.12 VAND \(immediate\)](#) on page 12-588.
- [12.13 VAND \(register\)](#) on page 12-589.
- [12.14 VBIC \(immediate\)](#) on page 12-590.
- [12.15 VBIC \(register\)](#) on page 12-591.
- [12.16 VBIF](#) on page 12-592.
- [12.17 VBIT](#) on page 12-593.
- [12.18 VBSL](#) on page 12-594.
- [12.19 VCEQ \(immediate #0\)](#) on page 12-595.
- [12.20 VCEQ \(register\)](#) on page 12-596.
- [12.21 VCGE \(immediate #0\)](#) on page 12-597.
- [12.22 VCGE \(register\)](#) on page 12-598.
- [12.23 VCGT \(immediate #0\)](#) on page 12-599.

- 12.24 *VCGT (register)* on page 12-600.
- 12.25 *VCLE (immediate #0)* on page 12-601.
- 12.26 *VCLE (register)* on page 12-602.
- 12.27 *VCLS* on page 12-603.
- 12.28 *VCLE (immediate #0)* on page 12-604.
- 12.29 *VCLE (register)* on page 12-605.
- 12.30 *VCLZ* on page 12-606.
- 12.31 *VCNT* on page 12-607.
- 12.32 *VCVT (between fixed-point or integer, and floating-point)* on page 12-608.
- 12.33 *VCVT (between half-precision and single-precision floating-point)* on page 12-609.
- 12.34 *VDUP* on page 12-610.
- 12.35 *VEOR* on page 12-611.
- 12.36 *VEXT* on page 12-612.
- 12.37 *VFMA, VFMS* on page 12-613.
- 12.38 *VHADD* on page 12-614.
- 12.39 *VHSUB* on page 12-615.
- 12.40 *VLDn (single n-element structure to one lane)* on page 12-616.
- 12.41 *VLDn (single n-element structure to all lanes)* on page 12-618.
- 12.42 *VLDn (multiple n-element structures)* on page 12-620.
- 12.43 *VLDM* on page 12-622.
- 12.44 *VLDR* on page 12-623.
- 12.45 *VLDR (post-increment and pre-decrement)* on page 12-624.
- 12.46 *VLDR pseudo-instruction* on page 12-625.
- 12.47 *VMAX and VMIN* on page 12-626.
- 12.48 *VMLA* on page 12-627.
- 12.49 *VMLA (by scalar)* on page 12-628.
- 12.50 *VMLAL (by scalar)* on page 12-629.
- 12.51 *VMLAL* on page 12-630.
- 12.52 *VMLS (by scalar)* on page 12-631.
- 12.53 *VMLS* on page 12-632.
- 12.54 *VMLSL* on page 12-633.
- 12.55 *VMLSL (by scalar)* on page 12-634.
- 12.56 *VMOV (floating-point)* on page 12-635.
- 12.57 *VMOV (immediate)* on page 12-636.
- 12.58 *VMOV (register)* on page 12-637.
- 12.59 *VMOV (between two ARM registers and a 64-bit extension register)* on page 12-638.
- 12.60 *VMOV (between an ARM register and a NEON scalar)* on page 12-639.
- 12.61 *VMOVL* on page 12-640.
- 12.62 *VMOVN* on page 12-641.
- 12.63 *VMOV2* on page 12-642.
- 12.64 *VMRS* on page 12-643.
- 12.65 *VMSR* on page 12-644.
- 12.66 *VMUL* on page 12-645.
- 12.67 *VMUL (by scalar)* on page 12-646.
- 12.68 *VMULL* on page 12-647.
- 12.69 *VMULL (by scalar)* on page 12-648.
- 12.70 *VMVN (register)* on page 12-649.
- 12.71 *VMVN (immediate)* on page 12-650.
- 12.72 *VNEG* on page 12-651.
- 12.73 *VORN (register)* on page 12-652.
- 12.74 *VORN (immediate)* on page 12-653.
- 12.75 *VORR (register)* on page 12-654.
- 12.76 *VORR (immediate)* on page 12-655.
- 12.77 *VPADAL* on page 12-656.
- 12.78 *VPADD* on page 12-657.
- 12.79 *VPADDL* on page 12-658.

- 12.80 *VPMAX* and *VPMIN* on page 12-659.
- 12.81 *VPOP* on page 12-660.
- 12.82 *VPUSH* on page 12-661.
- 12.83 *VQABS* on page 12-662.
- 12.84 *VQADD* on page 12-663.
- 12.85 *VQDMLAL* and *VQDMLSL* (by vector or by scalar) on page 12-664.
- 12.86 *VQDMULH* (by vector or by scalar) on page 12-665.
- 12.87 *VQDMULL* (by vector or by scalar) on page 12-666.
- 12.88 *VQMOVN* and *VQMOVUN* on page 12-667.
- 12.89 *VQNEG* on page 12-668.
- 12.90 *VQRDMULH* (by vector or by scalar) on page 12-669.
- 12.91 *VQRSHL* (by signed variable) on page 12-670.
- 12.92 *VQRSHRN* and *VQRSHRUN* (by immediate) on page 12-671.
- 12.93 *VQSHL* (by signed variable) on page 12-672.
- 12.94 *VQSHL* and *VQSHLU* (by immediate) on page 12-673.
- 12.95 *VQSHRN* and *VQSHRUN* (by immediate) on page 12-674.
- 12.96 *VQSUB* on page 12-675.
- 12.97 *VRADDHN* on page 12-676.
- 12.98 *VRECPE* on page 12-677.
- 12.99 *VRECPS* on page 12-678.
- 12.100 *VREV16*, *VREV32*, and *VREV64* on page 12-679.
- 12.101 *VRHADD* on page 12-680.
- 12.102 *VRSHL* (by signed variable) on page 12-681.
- 12.103 *VRSHR* (by immediate) on page 12-682.
- 12.104 *VRSHRN* (by immediate) on page 12-683.
- 12.105 *VRSQRTE* on page 12-684.
- 12.106 *VRSQRTS* on page 12-685.
- 12.107 *VRSRA* (by immediate) on page 12-686.
- 12.108 *VRSUBHN* on page 12-687.
- 12.109 *VSHL* (by immediate) on page 12-688.
- 12.110 *VSHL* (by signed variable) on page 12-689.
- 12.111 *VSHLL* (by immediate) on page 12-690.
- 12.112 *VSHR* (by immediate) on page 12-691.
- 12.113 *VSHRN* (by immediate) on page 12-692.
- 12.114 *VSLI* on page 12-693.
- 12.115 *VSRA* (by immediate) on page 12-694.
- 12.116 *VSRI* on page 12-695.
- 12.117 *VSTM* on page 12-696.
- 12.118 *VSTn* (multiple *n*-element structures) on page 12-697.
- 12.119 *VSTn* (single *n*-element structure to one lane) on page 12-699.
- 12.120 *VSTR* on page 12-701.
- 12.121 *VSTR* (post-increment and pre-decrement) on page 12-702.
- 12.122 *VSUB* on page 12-703.
- 12.123 *VSUBHN* on page 12-704.
- 12.124 *VSUBL* and *VSUBW* on page 12-705.
- 12.125 *VSWP* on page 12-706.
- 12.126 *VTBL* and *VTBX* on page 12-707.
- 12.127 *VTRN* on page 12-708.
- 12.128 *VTST* on page 12-709.
- 12.129 *VUZP* on page 12-710.
- 12.130 *VZIP* on page 12-711.

12.1 Summary of NEON instructions

Most NEON instructions are not available in VFP.

The following table shows a summary of the NEON instructions that are not available in VFP:

Table 12-1 Summary of NEON instructions

Mnemonic	Brief description
VABA, VABL	Absolute difference and Accumulate, Absolute difference and Accumulate Long
VABD, VABDL	Absolute difference, Absolute difference Long
VABS	Absolute value
VACGE, VACGT	Absolute Compare Greater than or Equal, Greater Than
VACLE, VACLT	Absolute Compare Less than or Equal, Less Than (pseudo-instructions)
VADD	Add
VADDHN	Add, select High half
VADDL, VADDW	Add Long, Add Wide
VAND	Bitwise AND
VAND	Bitwise AND (pseudo-instruction)
VBIC	Bitwise Bit Clear (register)
VBIC	Bitwise Bit Clear (immediate)
VBIF	Bitwise Insert if False
VBIT	Bitwise Insert if True
VBSL	Bitwise Select
VCEQ	Compare Equal (immediate, #0)
VCEQ	Compare Equal (register)
VCGE	Compare Greater than or Equal (immediate, #0)
VCGE	Compare Greater than or Equal (register)
VCGT	Compare Greater Than (immediate, #0)
VCGT	Compare Greater Than (register)
VCLE	Compare Less than or Equal (immediate, #0)
VCLE	Compare Less than or Equal (register)
VCLS	Count Leading Sign bits
VCNT	Count set bits
VCLT	Compare Less Than (immediate, #0)
VCLT	Compare Less Than (register)
VCLZ	Count Leading Zeros
VCVT	Convert fixed-point or integer to floating point, floating-point to integer or fixed-point
VCVT	Convert between half-precision and single-precision floating-point numbers
VDUP	Duplicate scalar to all lanes of vector

Table 12-1 Summary of NEON instructions (continued)

Mnemonic	Brief description
VEOR	Bitwise Exclusive OR
VEXT	Extract
VFMA, VFMS	Fused Multiply Accumulate, Fused Multiply Subtract (vector)
VHADD	Halving Add
VHSUB	Halving Subtract
VLD n	Load (single n -element structure to one lane)
VLD n	Load (single n -element structure to all lanes)
VLD n	Load (multiple n -element structures)
VMAX, VMIN	Maximum, Minimum
VMLA	Multiply Accumulate (by scalar)
VMLA	Multiply Accumulate (vector)
VMLAL	Multiply Accumulate Long (by scalar)
VMLAL	Multiply Accumulate Long (vector)
VMLS	Multiply Subtract (by scalar)
VMLS	Multiply Subtract (vector)
VMLSL	Multiply Subtract Long (by scalar)
VMLSL	Multiply Subtract Long (vector)
VMOV	Move (immediate)
VMOV	Move (register)
VMOVL	Move Long (register)
VMOVN	Move Narrow (register)
VMUL	Multiply (vector)
VMUL	Multiply (by scalar)
VMULL	Multiply Long (vector)
VMULL	Multiply Long (by scalar)
VMVN	Move Negative (immediate)
VMVN	Move Negative (register)
VNEG	Negate
VORN	Bitwise OR NOT
VORN	Bitwise OR NOT (pseudo-instruction)
VORR	Bitwise OR (register)
VORR	Bitwise OR (immediate)
VPADAL	Pairwise Add and Accumulate Long
VPADD	Pairwise Add
VPADDL	Pairwise Add Long

Table 12-1 Summary of NEON instructions (continued)

Mnemonic	Brief description
VPMAX, VPMIN	Pairwise Maximum, Pairwise Minimum
VQABS	Absolute value, saturate
VQADD	Add, saturate
VQDMLAL, VQDMLSL	Saturating Doubling Multiply Accumulate, and Multiply Subtract
VQDMULH	Saturating Doubling Multiply returning High half
VQDMULL	Saturating Doubling Multiply
VQMOV{U}N	Saturating Move and Narrow (register)
VQNEG	Negate, saturate
VQRDMULH	Saturating Doubling Multiply returning High half
VQRSHL	Shift Left, Round, saturate (by signed variable)
VQRSHR{U}N	Shift Right, Round, saturate (by immediate)
VQSHL	Shift Left, saturate (by signed variable)
VQSHL{U}	Shift Left, saturate (by immediate)
VQSHR{U}N	Shift Right, Narrow, saturate (by immediate)
VQSUB	Subtract, saturate
VRADDHN	Add, select High half, Round
VRECPE	Reciprocal Estimate
VRECPS	Reciprocal Step
VREV16, VREV32, VREV64	Reverse elements within halfwords, words, doublewords
VRHADD	Halving Add, Round
VRSHL	Shift Left and Round (by signed variable)
VRSHR	Shift Right and Round (by immediate)
VRSHRN	Shift Right, Round, Narrow (by immediate)
VRSQRTE	Reciprocal Square Root Estimate
VRSQRTS	Reciprocal Square Root Step
VRSRA	Shift Right, Round, and Accumulate (by immediate)
VRSUBHN	Subtract, select High half, Round
VSHL	Shift Left (by immediate)
VSHL	Shift Left (by signed variable)
VSHLL	Shift Left Long (by immediate)
VSHR	Shift Right (by immediate)
VSHRN	Shift Right, Narrow (by immediate)
VSLI	Shift Left and Insert
VSRA	Shift Right, Accumulate (by immediate)
VSRI	Shift Right and Insert

Table 12-1 Summary of NEON instructions (continued)

Mnemonic	Brief description
VSTn	Store (multiple n-element structures)
VSTn	Store (single n-element structure to one lane)
VSUB	Subtract
VSUBHN	Subtract, select High half
VSUBL, VSUBW	Subtract Long, Subtract Wide
VSWP	Swap vectors
VTBL, VTBX	Vector table look-up
VTRN	Vector transpose
VTST	Test bits
VUZP	Vector de-interleave
VZIP	Vector interleave

12.2 Summary of shared NEON and VFP instructions

Some instructions are common to NEON and VFP.

The following table shows a summary of the common instructions:

Table 12-2 Summary of shared NEON and VFP instructions

Mnemonic	Brief description	Op.	Arch.
VLDM	Load multiple	-	All
VLDR	Load (see also VLDR pseudo-instruction)	Scalar	All
	Load (post-increment and pre-decrement)	Scalar	All
VMOV	Transfer from one ARM register to half of a doubleword register	Scalar	All
	Transfer from half of a doubleword register to ARM register	Scalar	All
	Transfer from two ARM registers to a doubleword register	Scalar	All
	Transfer from a doubleword register to two ARM registers	Scalar	All
VMRS	Transfer from NEON and VFP system register to ARM register	-	All
VMSR	Transfer from ARM register to NEON and VFP system register	-	All
VPOP	Pop VFP or NEON registers from full-descending stack	-	All
VPUSH	Push VFP or NEON registers to full-descending stack	-	All
VSTM	Store multiple	-	All
VSTR	Store	Scalar	All
	Store (post-increment and pre-decrement)	Scalar	All

Related references

[12.43 VLDM](#) on page 12-622.

[12.44 VLDR](#) on page 12-623.

[12.59 VMOV \(between two ARM registers and a 64-bit extension register\)](#) on page 12-638.

[12.60 VMOV \(between an ARM register and a NEON scalar\)](#) on page 12-639.

[12.45 VLDR \(post-increment and pre-decrement\)](#) on page 12-624.

[12.46 VLDR pseudo-instruction](#) on page 12-625.

[12.64 VMRS](#) on page 12-643.

[12.65 VMSR](#) on page 12-644.

[12.81 VPOP](#) on page 12-660.

[12.82 VPUSH](#) on page 12-661.

[12.117 VSTM](#) on page 12-696.

[12.120 VSTR](#) on page 12-701.

[12.121 VSTR \(post-increment and pre-decrement\)](#) on page 12-702.

12.3 Interleaving provided by load and store element and structure instructions

Many instructions in this group provide interleaving when structures are stored to memory, and de-interleaving when structures are loaded from memory.

The following figure shows an example of de-interleaving. Interleaving is the inverse process.

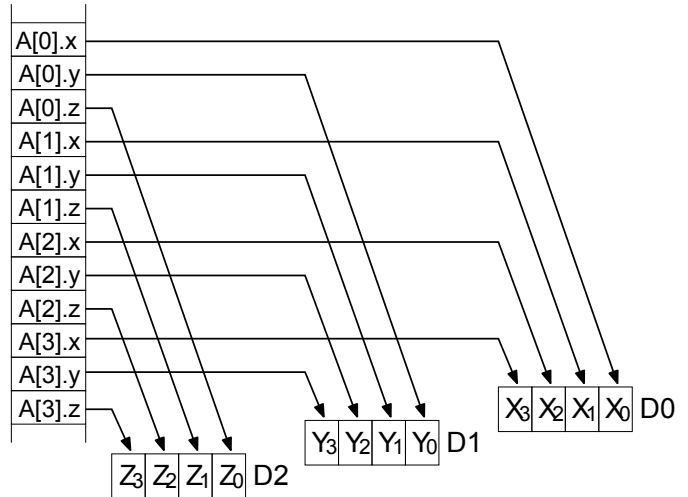

Figure 12-1 De-interleaving an array of 3-element structures

Related concepts

[12.4 Alignment restrictions in load and store element and structure instructions](#) on page 12-580.

Related references

[12.40 VLDn \(single n-element structure to one lane\)](#) on page 12-616.

[12.41 VLDn \(single n-element structure to all lanes\)](#) on page 12-618.

[12.42 VLDn \(multiple n-element structures\)](#) on page 12-620.

Related information

[ARM Architecture Reference Manual.](#)

12.4 Alignment restrictions in load and store element and structure instructions

Many of these instructions allow you to specify memory alignment restrictions.

When the alignment is not specified in the instruction, the alignment restriction is controlled by the A bit (SCTLR bit[1]):

- If the A bit is 0, there are no alignment restrictions (except for strongly-ordered or device memory, where accesses must be element-aligned).
- If the A bit is 1, accesses must be element-aligned.

If an address is not correctly aligned, an alignment fault occurs.

Related concepts

12.3 Interleaving provided by load and store element and structure instructions on page 12-579.

Related references

12.40 VLDn (single n-element structure to one lane) on page 12-616.

12.41 VLDn (single n-element structure to all lanes) on page 12-618.

12.42 VLDn (multiple n-element structures) on page 12-620.

Related information

ARM Architecture Reference Manual.

12.5 VABA and VABAL

Vector Absolute Difference and Accumulate.

Syntax

`VABA{cond}.datatype {Qd}, Qn, Qm`

`VABA{cond}.datatype {Dd}, Dn, Dm`

`VABAL{cond}.datatype Qd, Dn, Dm`

where:

cond

is an optional condition code.

datatype

must be one of S8, S16, S32, U8, U16, or U32.

Qd, Qn, Qm

are the destination vector, the first operand vector, and the second operand vector, for a quadword operation.

Dd, Dn, Dm

are the destination vector, the first operand vector, and the second operand vector, for a doubleword operation.

Qd, Dn, Dm

are the destination vector, the first operand vector, and the second operand vector, for a long operation.

Operation

VABA subtracts the elements of one vector from the corresponding elements of another vector, and accumulates the absolute values of the results into the elements of the destination vector.

VABAL is the long version of the VABA instruction.

Related concepts

[8.9 NEON data types on page 8-177.](#)

Related references

[11.8 Condition code suffixes on page 11-319.](#)

12.6 VABD and VABDL

Vector Absolute Difference.

Syntax

`VABD{cond}.datatype {Qd}, Qn, Qm`

`VABD{cond}.datatype {Dd}, Dn, Dm`

`VABDL{cond}.datatype Qd, Dn, Dm`

where:

cond

is an optional condition code.

datatype

must be one of:

- S8, S16, S32, U8, U16, or U32 for VABDL.
- S8, S16, S32, U8, U16, U32 or F32 for VABD.

Qd, Qn, Qm

are the destination vector, the first operand vector, and the second operand vector, for a quadword operation.

Dd, Dn, Dm

are the destination vector, the first operand vector, and the second operand vector, for a doubleword operation.

Qd, Dn, Dm

are the destination vector, the first operand vector, and the second operand vector, for a long operation.

Operation

VABD subtracts the elements of one vector from the corresponding elements of another vector, and places the absolute values of the results into the elements of the destination vector.

VABDL is the long version of the VABD instruction.

Related concepts

[8.9 NEON data types on page 8-177.](#)

Related references

[11.8 Condition code suffixes on page 11-319.](#)

12.7 VABS

Vector Absolute

Syntax

VABS{*cond*}.*datatype* *Qd*, *Qm*

VABS{*cond*}.*datatype* *Dd*, *Dm*

where:

cond

is an optional condition code.

datatype

must be one of S8, S16, S32, or F32.

Qd, *Qm*

are the destination vector and the operand vector, for a quadword operation.

Dd, *Dm*

are the destination vector and the operand vector, for a doubleword operation.

Operation

VABS takes the absolute value of each element in a vector, and places the results in a second vector. (The floating-point version only clears the sign bit.)

Related concepts

[8.9 NEON data types on page 8-177.](#)

Related references

[12.83 VQABS on page 12-662.](#)

[11.8 Condition code suffixes on page 11-319.](#)

12.8 VACLE, VACLT, VACGE and VACGT

Vector Absolute Compare.

Syntax

$VACop\{cond\}.F32 \{Qd\}, Qn, Qm$

$VACop\{cond\}.F32 \{Dd\}, Dn, Dm$

where:

op

must be one of:

GE	Absolute Greater than or Equal.
GT	Absolute Greater Than.
LE	Absolute Less than or Equal.
LT	Absolute Less Than.

cond

is an optional condition code.

Qd, Qn, Qm

specifies the destination register, the first operand register, and the second operand register, for a quadword operation.

Dd, Dn, Dm

specifies the destination register, the first operand register, and the second operand register, for a doubleword operation.

The result datatype is I32.

Operation

These instructions take the absolute value of each element in a vector, and compare it with the absolute value of the corresponding element of a second vector. If the condition is true, the corresponding element in the destination vector is set to all ones. Otherwise, it is set to all zeros.

Note

On disassembly, the VACLE and VACLT pseudo-instructions are disassembled to the corresponding VACGE and VACGT instructions, with the operands reversed.

Related references

[11.8 Condition code suffixes on page 11-319.](#)

12.9 VADD

Vector Add.

Syntax

VADD{*cond*}.*datatype* {*Qd*}, *Qn*, *Qm*

VADD{*cond*}.*datatype* {*Dd*}, *Dn*, *Dm*

where:

cond

is an optional condition code.

datatype

must be one of I8, I16, I32, I64, or F32

Qd, *Qn*, *Qm*

are the destination vector, the first operand vector, and the second operand vector, for a quadword operation.

Dd, *Dn*, *Dm*

are the destination vector, the first operand vector, and the second operand vector, for a doubleword operation.

Operation

VADD adds corresponding elements in two vectors, and places the results in the destination vector.

Related concepts

[8.9 NEON data types](#) on page 8-177.

Related references

[12.11 VADDL and VADDW](#) on page 12-587.

[12.84 VQADD](#) on page 12-663.

[11.8 Condition code suffixes](#) on page 11-319.

12.10 VADDHN

Vector Add and Narrow, selecting High half.

Syntax

VADDHN{*cond*}.*datatype* *Dd*, *Qn*, *Qm*

where:

cond

is an optional condition code.

datatype

must be one of I16, I32, or I64.

Dd, *Qn*, *Qm*

are the destination vector, the first operand vector, and the second operand vector.

Operation

VADDHN adds corresponding elements in two vectors, selects the most significant halves of the results, and places the final results in the destination vector. Results are truncated.

Related concepts

[8.9 NEON data types](#) on page 8-177.

Related references

[12.97 VRADDHN](#) on page 12-676.

[11.8 Condition code suffixes](#) on page 11-319.

12.11 VADDL and VADDW

Vector Add Long, Vector Add Wide.

Syntax

VADDL{*cond*}.*datatype* *Qd*, *Dn*, *Dm* ; Long operation

VADDW{*cond*}.*datatype* {*Qd*,} *Qn*, *Dm* ; Wide operation

where:

cond

is an optional condition code.

datatype

must be one of S8, S16, S32, U8, U16, or U32.

Qd, *Dn*, *Dm*

are the destination vector, the first operand vector, and the second operand vector, for a long operation.

Qd, *Qn*, *Dm*

are the destination vector, the first operand vector, and the second operand vector, for a wide operation.

Operation

VADDL adds corresponding elements in two doubleword vectors, and places the results in the destination quadword vector.

VADDW adds corresponding elements in one quadword and one doubleword vector, and places the results in the destination quadword vector.

Related concepts

[8.9 NEON data types](#) on page 8-177.

Related references

[12.9 VADD](#) on page 12-585.

[11.8 Condition code suffixes](#) on page 11-319.

12.12 VAND (immediate)

Vector bitwise AND immediate pseudo-instruction.

Syntax

VAND{*cond*}.*datatype* *Qd*, #*imm*

VAND{*cond*}.*datatype* *Dd*, #*imm*

where:

cond

is an optional condition code.

datatype

must be either I8, I16, I32, or I64.

Qd or *Dd*

is the NEON register for the result.

imm

is the immediate value.

Operation

VAND takes each element of the destination vector, performs a bitwise AND with an immediate value, and returns the result into the destination vector.

Note

On disassembly, this pseudo-instruction is disassembled to a corresponding VBIC instruction, with the complementary immediate value.

Immediate values

If *datatype* is I16, the immediate value must have one of the following forms:

- 0xFFXY.
- 0xXYFF.

If *datatype* is I32, the immediate value must have one of the following forms:

- 0xFFFFFFXY.
- 0xFFFFXYFF.
- 0xFFXYFFFF.
- 0XYFFFFFFF.

Related concepts

[8.9 NEON data types](#) on page 8-177.

Related references

[12.14 VBIC \(immediate\)](#) on page 12-590.

[11.8 Condition code suffixes](#) on page 11-319.

12.13 VAND (register)

Vector bitwise AND.

Syntax

VAND{*cond*}{*.datatype*} {*Qd*}, *Qn*, *Qm*

VAND{*cond*}{*.datatype*} {*Dd*}, *Dn*, *Dm*

where:

cond

is an optional condition code.

datatype

is an optional data type. The assembler ignores *datatype*.

Qd, *Qn*, *Qm*

specifies the destination register, the first operand register, and the second operand register, for a quadword operation.

Dd, *Dn*, *Dm*

specifies the destination register, the first operand register, and the second operand register, for a doubleword operation.

Operation

VAND performs a bitwise logical AND between two registers, and places the result in the destination register.

Related references

[11.8 Condition code suffixes on page 11-319.](#)

12.14 VBIC (immediate)

Vector Bit Clear immediate.

Syntax

`VBIC{cond}.datatype Qd, #imm`

`VBIC{cond}.datatype Dd, #imm`

where:

cond

is an optional condition code.

datatype

must be either I8, I16, I32, or I64.

Qd or *Dd*

is the NEON register for the source and result.

imm

is the immediate value.

Operation

VBIC takes each element of the destination vector, performs a bitwise AND complement with an immediate value, and returns the result in the destination vector.

Immediate values

You can either specify *imm* as a pattern which the assembler repeats to fill the destination register, or you can directly specify the immediate value (that conforms to the pattern) in full. The pattern for *imm* depends on *datatype* as shown in the following table:

Table 12-3 Patterns for immediate value in VBIC (immediate)

I16	I32
0x00XY	0x000000XY
0xXY00	0x0000XY00
	0x00XY0000
	0xXY000000

If you use the I8 or I64 datatypes, the assembler converts it to either the I16 or I32 instruction to match the pattern of *imm*. If the immediate value does not match any of the patterns in the preceding table, the assembler generates an error.

Related concepts

[8.9 NEON data types on page 8-177.](#)

Related references

[12.12 VAND \(immediate\) on page 12-588.](#)

[11.8 Condition code suffixes on page 11-319.](#)

12.15 VBIC (register)

Vector Bit Clear.

Syntax

`VBIC{cond}{.datatype} {Qd}, Qn, Qm`

`VBIC{cond}{.datatype} {Dd}, Dn, Dm`

where:

cond

is an optional condition code.

datatype

is an optional data type. The assembler ignores *datatype*.

Qd, *Qn*, *Qm*

specifies the destination register, the first operand register, and the second operand register, for a quadword operation.

Dd, *Dn*, *Dm*

specifies the destination register, the first operand register, and the second operand register, for a doubleword operation.

Operation

VBIC performs a bitwise logical AND complement between two registers, and places the result in the destination register.

Related references

[11.8 Condition code suffixes on page 11-319.](#)

12.16 VBIF

Vector Bitwise Insert if False.

Syntax

`VBIF{cond}{.datatype} {Qd}, Qn, Qm`

`VBIF{cond}{.datatype} {Dd}, Dn, Dm`

where:

cond

is an optional condition code.

datatype

is an optional datatype. The assembler ignores *datatype*.

Qd, Qn, Qm

specifies the destination register, the first operand register, and the second operand register, for a quadword operation.

Dd, Dn, Dm

specifies the destination register, the first operand register, and the second operand register, for a doubleword operation.

Operation

VBIF inserts each bit from the first operand into the destination if the corresponding bit of the second operand is 0, otherwise it leaves the destination bit unchanged.

Related references

[11.8 Condition code suffixes on page 11-319.](#)

12.17 VBIT

Vector Bitwise Insert if True.

Syntax

VBIT{*cond*}{*.datatype*} {*Qd*}, *Qn*, *Qm*

VBIT{*cond*}{*.datatype*} {*Dd*}, *Dn*, *Dm*

where:

cond

is an optional condition code.

datatype

is an optional datatype. The assembler ignores *datatype*.

Qd, *Qn*, *Qm*

specifies the destination register, the first operand register, and the second operand register, for a quadword operation.

Dd, *Dn*, *Dm*

specifies the destination register, the first operand register, and the second operand register, for a doubleword operation.

Operation

VBIT inserts each bit from the first operand into the destination if the corresponding bit of the second operand is 1, otherwise it leaves the destination bit unchanged.

Related references

[11.8 Condition code suffixes on page 11-319.](#)

12.18 VBSL

Vector Bitwise Select.

Syntax

VBSL{*cond*}{*.datatype*} {*Qd*}, *Qn*, *Qm*

VBSL{*cond*}{*.datatype*} {*Dd*}, *Dn*, *Dm*

where:

cond

is an optional condition code.

datatype

is an optional datatype. The assembler ignores *datatype*.

Qd, *Qn*, *Qm*

specifies the destination register, the first operand register, and the second operand register, for a quadword operation.

Dd, *Dn*, *Dm*

specifies the destination register, the first operand register, and the second operand register, for a doubleword operation.

Operation

VBSL selects each bit for the destination from the first operand if the corresponding bit of the destination is 1, or from the second operand if the corresponding bit of the destination is 0.

Related references

[11.8 Condition code suffixes on page 11-319.](#)

12.19 VCEQ (immediate #0)

Vector Compare Equal to zero.

Syntax

VCEQ{*cond*}.datatype {*Qd*}, *Qn*, #0

VCEQ{*cond*}.datatype {*Dd*}, *Dn*, #0

where:

cond

is an optional condition code.

datatype

must be one of I8, I16, I32, or F32.

The result datatype is:

- I32 for operand datatypes I32 or F32.
- I16 for operand datatype I16.
- I8 for operand datatype I8.

Qd, *Qn*, *Qm*

specifies the destination register and the operand register, for a quadword operation.

Dd, *Dn*, *Dm*

specifies the destination register and the operand register, for a doubleword operation.

#0

specifies a comparison with zero.

Operation

VCEQ takes the value of each element in a vector, and compares it with zero. If the condition is true, the corresponding element in the destination vector is set to all ones. Otherwise, it is set to all zeros.

Related concepts

[8.9 NEON data types on page 8-177.](#)

Related references

[11.8 Condition code suffixes on page 11-319.](#)

12.20 VCEQ (register)

Vector Compare Equal.

Syntax

$VCEQ\{cond\}.datatype\ \{Qd\},\ Qn,\ Qm$

$VCEQ\{cond\}.datatype\ \{Dd\},\ Dn,\ Dm$

where:

cond

is an optional condition code.

datatype

must be one of I8, I16, I32, or F32.

The result datatype is:

- I32 for operand datatypes I32 or F32.
- I16 for operand datatype I16.
- I8 for operand datatype I8.

Qd, Qn, Qm

specifies the destination register, the first operand register, and the second operand register, for a quadword operation.

Dd, Dn, Dm

specifies the destination register, the first operand register, and the second operand register, for a doubleword operation.

Operation

VCEQ takes the value of each element in a vector, and compares it with the value of the corresponding element of a second vector. If the condition is true, the corresponding element in the destination vector is set to all ones. Otherwise, it is set to all zeros.

Related concepts

[8.9 NEON data types](#) on page 8-177.

Related references

[12.26 VCLE \(register\)](#) on page 12-602.

[12.29 VCLT \(register\)](#) on page 12-605.

[11.8 Condition code suffixes](#) on page 11-319.

12.21 VCGE (immediate #0)

Vector Compare Greater than or Equal to zero.

Syntax

`VCGE{cond}.datatype {Qd}, Qn, #0`

`VCGE{cond}.datatype {Dd}, Dn, #0`

where:

cond

is an optional condition code.

datatype

must be one of S8, S16, S32, or F32.

The result datatype is:

- I32 for operand datatypes S32 or F32.
- I16 for operand datatype S16.
- I8 for operand datatype S8.

Qd, Qn, Qm

specifies the destination register and the operand register, for a quadword operation.

Dd, Dn, Dm

specifies the destination register and the operand register, for a doubleword operation.

#0

specifies a comparison with zero.

Operation

VCGE takes the value of each element in a vector, and compares it with zero. If the condition is true, the corresponding element in the destination vector is set to all ones. Otherwise, it is set to all zeros.

Related concepts

[8.9 NEON data types](#) on page 8-177.

Related references

[12.26 VCLE \(register\)](#) on page 12-602.

[12.29 VCLT \(register\)](#) on page 12-605.

[11.8 Condition code suffixes](#) on page 11-319.

12.22 VCGE (register)

Vector Compare Greater than or Equal.

Syntax

$VCGE\{cond\}.datatype\ \{Qd\},\ Qn,\ Qm$

$VCGE\{cond\}.datatype\ \{Dd\},\ Dn,\ Dm$

where:

cond

is an optional condition code.

datatype

must be one of S8, S16, S32, U8, U16, U32, or F32.

The result datatype is:

- I32 for operand datatypes S32, U32, or F32.
- I16 for operand datatypes S16 or U16.
- I8 for operand datatypes S8 or U8.

Qd, Qn, Qm

specifies the destination register, the first operand register, and the second operand register, for a quadword operation.

Dd, Dn, Dm

specifies the destination register, the first operand register, and the second operand register, for a doubleword operation.

Operation

VCGE takes the value of each element in a vector, and compares it with the value of the corresponding element of a second vector. If the condition is true, the corresponding element in the destination vector is set to all ones. Otherwise, it is set to all zeros.

Related concepts

[8.9 NEON data types on page 8-177.](#)

Related references

[12.26 VCLE \(register\) on page 12-602.](#)

[12.29 VCLT \(register\) on page 12-605.](#)

[11.8 Condition code suffixes on page 11-319.](#)

12.23 VCGT (immediate #0)

Vector Compare Greater Than zero.

Syntax

`VCGT{cond}.datatype {Qd}, Qn, #0`

`VCGT{cond}.datatype {Dd}, Dn, #0`

where:

cond

is an optional condition code.

datatype

must be one of S8, S16, S32, or F32.

The result datatype is:

- I32 for operand datatypes S32 or F32.
- I16 for operand datatype S16.
- I8 for operand datatype S8.

Qd, Qn, Qm

specifies the destination register and the operand register, for a quadword operation.

Dd, Dn, Dm

specifies the destination register and the operand register, for a doubleword operation.

Operation

VCGT takes the value of each element in a vector, and compares it with zero. If the condition is true, the corresponding element in the destination vector is set to all ones. Otherwise, it is set to all zeros.

Related concepts

[8.9 NEON data types](#) on page 8-177.

Related references

[12.26 VCLE \(register\)](#) on page 12-602.

[12.29 VCLT \(register\)](#) on page 12-605.

[11.8 Condition code suffixes](#) on page 11-319.

12.24 VCGT (register)

Vector Compare Greater Than.

Syntax

$VCGT\{cond\}.datatype\ \{Qd\},\ Qn,\ Qm$

$VCGT\{cond\}.datatype\ \{Dd\},\ Dn,\ Dm$

where:

cond

is an optional condition code.

datatype

must be one of S8, S16, S32, U8, U16, U32, or F32.

The result datatype is:

- I32 for operand datatypes S32, U32, or F32.
- I16 for operand datatypes S16 or U16.
- I8 for operand datatypes S8 or U8.

Qd, Qn, Qm

specifies the destination register, the first operand register, and the second operand register, for a quadword operation.

Dd, Dn, Dm

specifies the destination register, the first operand register, and the second operand register, for a doubleword operation.

Operation

VCGT takes the value of each element in a vector, and compares it with the value of the corresponding element of a second vector. If the condition is true, the corresponding element in the destination vector is set to all ones. Otherwise, it is set to all zeros.

Related concepts

[8.9 NEON data types](#) on page 8-177.

Related references

[12.26 VCLE \(register\)](#) on page 12-602.

[12.29 VCLT \(register\)](#) on page 12-605.

[11.8 Condition code suffixes](#) on page 11-319.

12.25 VCLE (immediate #0)

Vector Compare Less than or Equal to zero.

Syntax

`VCLE{cond}.datatype {Qd}, Qn, #0`

`VCLE{cond}.datatype {Dd}, Dn, #0`

where:

cond

is an optional condition code.

datatype

must be one of S8, S16, S32, or F32.

The result datatype is:

- I32 for operand datatypes S32 or F32.
- I16 for operand datatype S16.
- I8 for operand datatype S8.

Qd, Qn, Qm

specifies the destination register and the operand register, for a quadword operation.

Dd, Dn, Dm

specifies the destination register and the operand register, for a doubleword operation.

#0

specifies a comparison with zero.

Operation

VCLE takes the value of each element in a vector, and compares it with zero. If the condition is true, the corresponding element in the destination vector is set to all ones. Otherwise, it is set to all zeros.

Related concepts

[8.9 NEON data types](#) on page 8-177.

Related references

[12.26 VCLE \(register\)](#) on page 12-602.

[12.29 VCLT \(register\)](#) on page 12-605.

[11.8 Condition code suffixes](#) on page 11-319.

12.26 VCLE (register)

Vector Compare Less than or Equal pseudo-instruction.

Syntax

`VCLE{cond}.datatype {Qd}, Qn, Qm`

`VCLE{cond}.datatype {Dd}, Dn, Dm`

where:

cond

is an optional condition code.

datatype

must be one of S8, S16, S32, U8, U16, U32, or F32.

The result datatype is:

- I32 for operand datatypes S32, U32, or F32.
- I16 for operand datatypes S16 or U16.
- I8 for operand datatypes S8 or U8.

Qd, Qn, Qm

specifies the destination register, the first operand register, and the second operand register, for a quadword operation.

Dd, Dn, Dm

specifies the destination register, the first operand register, and the second operand register, for a doubleword operation.

Operation

VCLE takes the value of each element in a vector, and compares it with the value of the corresponding element of a second vector. If the condition is true, the corresponding element in the destination vector is set to all ones. Otherwise, it is set to all zeros.

On disassembly, this pseudo-instruction is disassembled to the corresponding VCGE instruction, with the operands reversed.

Related concepts

[8.9 NEON data types on page 8-177.](#)

Related references

[11.8 Condition code suffixes on page 11-319.](#)

12.27 VCLS

Vector Count Leading Sign bits.

Syntax

`VCLS{cond}.datatype Qd, Qm`

`VCLS{cond}.datatype Dd, Dm`

where:

cond

is an optional condition code.

datatype

must be one of S8, S16, or S32.

Qd, Qm

are the destination vector and the operand vector, for a quadword operation.

Dd, Dm

are the destination vector and the operand vector, for a doubleword operation.

Operation

VCLS counts the number of consecutive bits following the topmost bit, that are the same as the topmost bit, in each element in a vector, and places the results in a second vector.

Related concepts

[8.9 NEON data types on page 8-177.](#)

Related references

[11.8 Condition code suffixes on page 11-319.](#)

12.28 VCLT (immediate #0)

Vector Compare Less Than zero.

Syntax

VCLT{*cond*}.datatype {*Qd*}, *Qn*, #0

VCLT{*cond*}.datatype {*Dd*}, *Dn*, #0

where:

cond

is an optional condition code.

datatype

must be one of S8, S16, S32, or F32.

The result datatype is:

- I32 for operand datatypes S32 or F32.
- I16 for operand datatype S16.
- I8 for operand datatype S8.

Qd, *Qn*, *Qm*

specifies the destination register and the operand register, for a quadword operation.

Dd, *Dn*, *Dm*

specifies the destination register and the operand register, for a doubleword operation.

#0

specifies a comparison with zero.

Operation

VCLT takes the value of each element in a vector, and compares it with zero. If the condition is true, the corresponding element in the destination vector is set to all ones. Otherwise, it is set to all zeros.

Related concepts

[8.9 NEON data types on page 8-177.](#)

Related references

[11.8 Condition code suffixes on page 11-319.](#)

12.29 VCLT (register)

Vector Compare Less Than.

Syntax

$VCLT\{cond\}.datatype \{Qd\}, Qn, Qm$

$VCLT\{cond\}.datatype \{Dd\}, Dn, Dm$

where:

cond

is an optional condition code.

datatype

must be one of S8, S16, S32, U8, U16, U32, or F32.

The result datatype is:

- I32 for operand datatypes S32, U32, or F32.
- I16 for operand datatypes S16 or U16.
- I8 for operand datatypes S8 or U8.

Qd, Qn, Qm

specifies the destination register, the first operand register, and the second operand register, for a quadword operation.

Dd, Dn, Dm

specifies the destination register, the first operand register, and the second operand register, for a doubleword operation.

Operation

VCLT takes the value of each element in a vector, and compares it with the value of the corresponding element of a second vector. If the condition is true, the corresponding element in the destination vector is set to all ones. Otherwise, it is set to all zeros.

Note

On disassembly, this pseudo-instruction is disassembled to the corresponding VCGT instruction, with the operands reversed.

Related concepts

[8.9 NEON data types on page 8-177.](#)

Related references

[11.8 Condition code suffixes on page 11-319.](#)

12.30 VCLZ

Vector Count Leading Zeros.

Syntax

VCLZ{*cond*}.*datatype* *Qd*, *Qm*

VCLZ{*cond*}.*datatype* *Dd*, *Dm*

where:

cond

is an optional condition code.

datatype

must be one of I8, I16, or I32.

Qd, *Qm*

are the destination vector and the operand vector, for a quadword operation.

Dd, *Dm*

are the destination vector and the operand vector, for a doubleword operation.

Operation

VCLZ counts the number of consecutive zeros, starting from the top bit, in each element in a vector, and places the results in a second vector.

Related concepts

[8.9 NEON data types on page 8-177.](#)

Related references

[11.8 Condition code suffixes on page 11-319.](#)

12.31 VCNT

Vector Count set bits.

Syntax

`VCNT{cond}.datatype Qd, Qm`

`VCNT{cond}.datatype Dd, Dm`

where:

cond

is an optional condition code.

datatype

must be I8.

Qd, *Qm*

are the destination vector and the operand vector, for a quadword operation.

Dd, *Dm*

are the destination vector and the operand vector, for a doubleword operation.

Operation

VCNT counts the number of bits that are one in each element in a vector, and places the results in a second vector.

Related concepts

[8.9 NEON data types on page 8-177.](#)

Related references

[11.8 Condition code suffixes on page 11-319.](#)

12.32 VCVT (between fixed-point or integer, and floating-point)

Vector Convert.

Syntax

`VCVT{cond}.type Qd, Qm {, #fbits}`

`VCVT{cond}.type Dd, Dm {, #fbits}`

where:

cond

is an optional condition code.

type

specifies the data types for the elements of the vectors. It must be one of:

`S32.F32`

Floating-point to signed integer or fixed-point.

`U32.F32`

Floating-point to unsigned integer or fixed-point.

`F32.S32`

Signed integer or fixed-point to floating-point.

`F32.U32`

Unsigned integer or fixed-point to floating-point.

Qd, Qm

specifies the destination vector and the operand vector, for a quadword operation.

Dd, Dm

specifies the destination vector and the operand vector, for a doubleword operation.

fbits

if present, specifies the number of fraction bits in the fixed point number. Otherwise, the conversion is between floating-point and integer. *fbits* must lie in the range 0-32. If *fbits* is omitted, the number of fraction bits is 0.

Operation

VCVT converts each element in a vector in one of the following ways, and places the results in the destination vector:

- From floating-point to integer.
- From integer to floating-point.
- From floating-point to fixed-point.
- From fixed-point to floating-point.

Rounding

Integer or fixed-point to floating-point conversions use round to nearest.

Floating-point to integer or fixed-point conversions use round towards zero.

Related references

[11.8 Condition code suffixes on page 11-319.](#)

12.33 VCVT (between half-precision and single-precision floating-point)

Vector Convert.

Syntax

$VCVT\{cond\}.F32.F16\ Qd, Dm$

$VCVT\{cond\}.F16.F32\ Dd, Qm$

where:

cond

is an optional condition code.

Qd, Dm

specifies the destination vector for the single-precision results and the half-precision operand vector.

Dd, Qm

specifies the destination vector for half-precision results and the single-precision operand vector.

Operation

VCVT with half-precision extension, converts each element in a vector in one of the following ways, and places the results in the destination vector:

- From half-precision floating-point to single-precision floating-point (F32.F16).
- From single-precision floating-point to half-precision floating-point (F16.F32).

Architectures

This instruction is only available in NEON systems with the half-precision extension.

Related references

[11.8 Condition code suffixes on page 11-319.](#)

12.34 VDUP

Vector Duplicate.

Syntax

`VDUP{cond}.size Qd, Dm[x]`

`VDUP{cond}.size Dd, Dm[x]`

`VDUP{cond}.size Qd, Rm`

`VDUP{cond}.size Dd, Rm`

where:

cond

is an optional condition code.

size

must be 8, 16, or 32.

Qd

specifies the destination register for a quadword operation.

Dd

specifies the destination register for a doubleword operation.

Dm[x]

specifies the NEON scalar.

Rm

specifies the ARM register. *Rm* must not be PC.

Operation

VDUP duplicates a scalar into every element of the destination vector. The source can be a NEON scalar or an ARM register.

Related references

[11.8 Condition code suffixes on page 11-319.](#)

12.35 VEOR

Vector Bitwise Exclusive OR.

Syntax

VEOR{*cond*}{*.datatype*} {*Qd*}, *Qn*, *Qm*

VEOR{*cond*}{*.datatype*} {*Dd*}, *Dn*, *Dm*

where:

cond

is an optional condition code.

datatype

is an optional data type. The assembler ignores *datatype*.

Qd, *Qn*, *Qm*

specifies the destination register, the first operand register, and the second operand register, for a quadword operation.

Dd, *Dn*, *Dm*

specifies the destination register, the first operand register, and the second operand register, for a doubleword operation.

Operation

VEOR performs a logical exclusive OR between two registers, and places the result in the destination register.

Related references

[11.8 Condition code suffixes on page 11-319.](#)

12.36 VEXT

Vector Extract.

Syntax

VEXT{*cond*}.8 {*Qd*}, *Qn*, *Qm*, #*imm*

VEXT{*cond*}.8 {*Dd*}, *Dn*, *Dm*, #*imm*

where:

cond

is an optional condition code.

Qd, *Qn*, *Qm*

specifies the destination register, the first operand register, and the second operand register, for a quadword operation.

Dd, *Dn*, *Dm*

specifies the destination register, the first operand register, and the second operand register, for a doubleword operation.

imm

is the number of 8-bit elements to extract from the bottom of the second operand vector, in the range 0-7 for doubleword operations, or 0-15 for quadword operations.

Operation

VEXT extracts 8-bit elements from the bottom end of the second operand vector and the top end of the first, concatenates them, and places the result in the destination vector. See the following figure for an example:

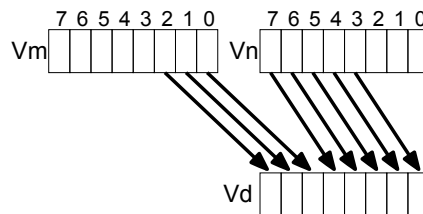

Figure 12-2 Operation of doubleword VEXT for *imm* = 3

VEXT pseudo-instruction

You can specify a datatype of 16, 32, or 64 instead of 8. In this case, #*imm* refers to halfwords, words, or doublewords instead of referring to bytes, and the permitted ranges are correspondingly reduced.

Related references

[11.8 Condition code suffixes on page 11-319.](#)

12.37 VFMA, VFMS

Vector Fused Multiply Accumulate, Vector Fused Multiply Subtract.

Syntax

$Vop\{cond\}.F32 \{Qd\}, Qn, Qm$

$Vop\{cond\}.F32 \{Dd\}, Dn, Dm$

where:

op

is one of FMA or FMS.

cond

is an optional condition code.

Dd, Dn, Dm

are the destination and operand vectors for doubleword operation.

Qd, Qn, Qm

are the destination and operand vectors for quadword operation.

Operation

VFMA multiplies corresponding elements in the two operand vectors, and accumulates the results into the elements of the destination vector. The result of the multiply is not rounded before the accumulation.

VFMS multiplies corresponding elements in the two operand vectors, then subtracts the products from the corresponding elements of the destination vector, and places the final results in the destination vector. The result of the multiply is not rounded before the subtraction.

Related references

[12.66 VMUL on page 12-645.](#)

[11.8 Condition code suffixes on page 11-319.](#)

12.38 VHADD

Vector Halving Add.

Syntax

VHADD{*cond*}.*datatype* {*Qd*}, *Qn*, *Qm*

VHADD{*cond*}.*datatype* {*Dd*}, *Dn*, *Dm*

where:

cond

is an optional condition code.

datatype

must be one of S8, S16, S32, U8, U16, or U32.

Qd, *Qn*, *Qm*

are the destination vector, the first operand vector, and the second operand vector, for a quadword operation.

Dd, *Dn*, *Dm*

are the destination vector, the first operand vector, and the second operand vector, for a doubleword operation.

Operation

VHADD adds corresponding elements in two vectors, shifts each result right one bit, and places the results in the destination vector. Results are truncated.

Related concepts

[8.9 NEON data types on page 8-177.](#)

Related references

[11.8 Condition code suffixes on page 11-319.](#)

12.39 VHSUB

Vector Halving Subtract.

Syntax

VHSUB{*cond*}.*datatype* {*Qd*}, *Qn*, *Qm*

VHSUB{*cond*}.*datatype* {*Dd*}, *Dn*, *Dm*

where:

cond

is an optional condition code.

datatype

must be one of S8, S16, S32, U8, U16, or U32.

Qd, *Qn*, *Qm*

are the destination vector, the first operand vector, and the second operand vector, for a quadword operation.

Dd, *Dn*, *Dm*

are the destination vector, the first operand vector, and the second operand vector, for a doubleword operation.

Operation

VHSUB subtracts the elements of one vector from the corresponding elements of another vector, shifts each result right one bit, and places the results in the destination vector. Results are always truncated.

Related concepts

[8.9 NEON data types on page 8-177.](#)

Related references

[11.8 Condition code suffixes on page 11-319.](#)

12.40 VLDn (single n-element structure to one lane)

Vector Load single *n*-element structure to one lane.

Syntax

VLDn{*cond*}.*datatype* *List*, [*Rn*{@*align*}]{!}

VLDn{*cond*}.*datatype* *List*, [*Rn*{@*align*}], *Rm*

where:

n

must be one of 1, 2, 3, or 4.

cond

is an optional condition code.

datatype

see the following table.

List

is the list of NEON registers enclosed in braces, { and }. See the following table for options.

Rn

is the ARM register containing the base address. *Rn* cannot be PC.

align

specifies an optional alignment. See the following table for options.

!

if ! is present, *Rn* is updated to (*Rn* + the number of bytes transferred by the instruction). The update occurs after all the loads have taken place.

Rm

is an ARM register containing an offset from the base address. If *Rm* is present, the instruction updates *Rn* to (*Rn* + *Rm*) after using the address to access memory. *Rm* cannot be SP or PC.

Operation

VLDn loads one *n*-element structure from memory into one or more NEON registers. Elements of the register that are not loaded are unaltered.

Table 12-4 Permitted combinations of parameters for VLDn (single n-element structure to one lane)

<i>n</i>	<i>datatype</i>	<i>list</i> ^{ai}	<i>align</i> ^{aj}	alignment
1	8	{Dd[x]}	-	Standard only
	16	{Dd[x]}	@16	2-byte
	32	{Dd[x]}	@32	4-byte
2	8	{Dd[x], D(d+1)[x]}	@16	2-byte
	16	{Dd[x], D(d+1)[x]}	@32	4-byte
		{Dd[x], D(d+2)[x]}	@32	4-byte
	32	{Dd[x], D(d+1)[x]}	@64	8-byte
		{Dd[x], D(d+2)[x]}	@64	8-byte
3	8	{Dd[x], D(d+1)[x], D(d+2)[x]}	-	Standard only
	16 or 32	{Dd[x], D(d+1)[x], D(d+2)[x]}	-	Standard only
		{Dd[x], D(d+2)[x], D(d+4)[x]}	-	Standard only

^{ai} Every register in the list must be in the range D0-D31.

^{aj} *align* can be omitted. In this case, standard alignment rules apply.

Table 12-4 Permitted combinations of parameters for VLDn (single n-element structure to one lane) (continued)

<i>n</i>	<i>datatype</i>	<i>list</i> ^{ai}	<i>align</i> ^{aj}	alignment
4	8	{Dd[x], D(d+1)[x], D(d+2)[x], D(d+3)[x]}	@32	4-byte
	16	{Dd[x], D(d+1)[x], D(d+2)[x], D(d+3)[x]}	@64	8-byte
		{Dd[x], D(d+2)[x], D(d+4)[x], D(d+6)[x]}	@64	8-byte
	32	{Dd[x], D(d+1)[x], D(d+2)[x], D(d+3)[x]}	@64 or @128	8-byte or 16-byte
		{Dd[x], D(d+2)[x], D(d+4)[x], D(d+6)[x]}	@64 or @128	8-byte or 16-byte

Related concepts

12.3 Interleaving provided by load and store element and structure instructions on page 12-579.

12.4 Alignment restrictions in load and store element and structure instructions on page 12-580.

Related references

12.41 VLDn (single n-element structure to all lanes) on page 12-618.

12.42 VLDn (multiple n-element structures) on page 12-620.

11.8 Condition code suffixes on page 11-319.

12.41 VLDn (single n-element structure to all lanes)

Vector Load single *n*-element structure to all lanes.

Syntax

VLDn{*cond*}.*datatype* *List*, [*Rn*{@*align*}]{!}

VLDn{*cond*}.*datatype* *List*, [*Rn*{@*align*}], *Rm*

where:

n
 must be one of 1, 2, 3, or 4.

cond
 is an optional condition code.

datatype
 see the following table.

List
 is the list of NEON registers enclosed in braces, { and }. See the following table for options.

Rn
 is the ARM register containing the base address. *Rn* cannot be PC.

align
 specifies an optional alignment. See the following table for options.

!
 if ! is present, *Rn* is updated to (*Rn* + the number of bytes transferred by the instruction). The update occurs after all the loads have taken place.

Rm
 is an ARM register containing an offset from the base address. If *Rm* is present, the instruction updates *Rn* to (*Rn* + *Rm*) after using the address to access memory. *Rm* cannot be SP or PC.

Operation

VLDn loads multiple copies of one *n*-element structure from memory into one or more NEON registers.

Table 12-5 Permitted combinations of parameters for VLDn (single n-element structure to all lanes)

<i>n</i>	<i>datatype</i>	<i>list</i> ^{ak}	<i>align</i> ^{al}	alignment
1	8	{Dd[]}	-	Standard only
		{Dd[], D(d+1)[]}	-	Standard only
	16	{Dd[]}	@16	2-byte
		{Dd[], D(d+1)[]}	@16	2-byte
	32	{Dd[]}	@32	4-byte
		{Dd[], D(d+1)[]}	@32	4-byte
2	8	{Dd[], D(d+1)[]}	@8	byte
		{Dd[], D(d+2)[]}	@8	byte
	16	{Dd[], D(d+1)[]}	@16	2-byte
		{Dd[], D(d+2)[]}	@16	2-byte
	32	{Dd[], D(d+1)[]}	@32	4-byte

^{ak} Every register in the list must be in the range D0-D31.
^{al} *align* can be omitted. In this case, standard alignment rules apply.

Table 12-5 Permitted combinations of parameters for VLDn (single n-element structure to all lanes) (continued)

<i>n</i>	<i>datatype</i>	<i>list</i> ^{ak}	<i>align</i> ^{al}	alignment
		{Dd[], D(d+2)[]}	@32	4-byte
3	8, 16, or 32	{Dd[], D(d+1)[], D(d+2)[]}	-	Standard only
		{Dd[], D(d+2)[], D(d+4)[]}	-	Standard only
4	8	{Dd[], D(d+1)[], D(d+2)[], D(d+3)[]}	@32	4-byte
		{Dd[], D(d+2)[], D(d+4)[], D(d+6)[]}	@32	4-byte
	16	{Dd[], D(d+1)[], D(d+2)[], D(d+3)[]}	@64	8-byte
		{Dd[], D(d+2)[], D(d+4)[], D(d+6)[]}	@64	8-byte
	32	{Dd[], D(d+1)[], D(d+2)[], D(d+3)[]}	@64 or @128	8-byte or 16-byte
		{Dd[], D(d+2)[], D(d+4)[], D(d+6)[]}	@64 or @128	8-byte or 16-byte

Related concepts

12.3 Interleaving provided by load and store element and structure instructions on page 12-579.

12.4 Alignment restrictions in load and store element and structure instructions on page 12-580.

Related references

12.40 VLDn (single n-element structure to one lane) on page 12-616.

12.42 VLDn (multiple n-element structures) on page 12-620.

11.8 Condition code suffixes on page 11-319.

12.42 VLDn (multiple n-element structures)

Vector Load multiple *n*-element structures.

Syntax

VLDn{*cond*}.*datatype* *List*, [*Rn*{@*align*}]*!*

VLDn{*cond*}.*datatype* *List*, [*Rn*{@*align*}], *Rm*

where:

n

must be one of 1, 2, 3, or 4.

cond

is an optional condition code.

datatype

see the following table for options.

List

is the list of NEON registers enclosed in braces, { and }. See the following table for options.

Rn

is the ARM register containing the base address. *Rn* cannot be PC.

align

specifies an optional alignment. See the following table for options.

!

if ! is present, *Rn* is updated to (*Rn* + the number of bytes transferred by the instruction). The update occurs after all the loads have taken place.

Rm

is an ARM register containing an offset from the base address. If *Rm* is present, the instruction updates *Rn* to (*Rn* + *Rm*) after using the address to access memory. *Rm* cannot be SP or PC.

Operation

VLDn loads multiple *n*-element structures from memory into one or more NEON registers, with de-interleaving (unless *n* == 1). Every element of each register is loaded.

Table 12-6 Permitted combinations of parameters for VLDn (multiple n-element structures)

<i>n</i>	<i>datatype</i>	<i>list</i> ^{am}	<i>align</i> ^{an}	<i>alignment</i>
1	8, 16, 32, or 64	{Dd}	@64	8-byte
		{Dd, D(d+1)}	@64 or @128	8-byte or 16-byte
		{Dd, D(d+1), D(d+2)}	@64	8-byte
		{Dd, D(d+1), D(d+2), D(d+3)}	@64, @128, or @256	8-byte, 16-byte, or 32-byte
2	8, 16, or 32	{Dd, D(d+1)}	@64, @128	8-byte or 16-byte
		{Dd, D(d+2)}	@64, @128	8-byte or 16-byte
		{Dd, D(d+1), D(d+2), D(d+3)}	@64, @128, or @256	8-byte, 16-byte, or 32-byte
3	8, 16, or 32	{Dd, D(d+1), D(d+2)}	@64	8-byte
		{Dd, D(d+2), D(d+4)}	@64	8-byte
4	8, 16, or 32	{Dd, D(d+1), D(d+2), D(d+3)}	@64, @128, or @256	8-byte, 16-byte, or 32-byte
		{Dd, D(d+2), D(d+4), D(d+6)}	@64, @128, or @256	8-byte, 16-byte, or 32-byte

^{am} Every register in the list must be in the range D0-D31.
^{an} *align* can be omitted. In this case, standard alignment rules apply.

Related concepts

12.3 Interleaving provided by load and store element and structure instructions on page 12-579.

12.4 Alignment restrictions in load and store element and structure instructions on page 12-580.

Related references

12.40 VLDn (single n-element structure to one lane) on page 12-616.

12.41 VLDn (single n-element structure to all lanes) on page 12-618.

11.8 Condition code suffixes on page 11-319.

12.43 VLDM

Extension register load multiple.

Syntax

`VLDMmode{cond} Rn{!}, Registers`

where:

mode

must be one of:

IA

meaning Increment address After each transfer. IA is the default, and can be omitted.

DB

meaning Decrement address Before each transfer.

EA

meaning Empty Ascending stack operation. This is the same as DB for loads.

FD

meaning Full Descending stack operation. This is the same as IA for loads.

cond

is an optional condition code.

Rn

is the ARM register holding the base address for the transfer.

!

is optional. ! specifies that the updated base address must be written back to *Rn*. If ! is not specified, *mode* must be IA.

Registers

is a list of consecutive extension registers enclosed in braces, { and }. The list can be comma-separated, or in range format. There must be at least one register in the list.

You can specify D or Q registers, but they must not be mixed. The number of registers must not exceed 16 D registers, or 8 Q registers. If Q registers are specified, on disassembly they are shown as D registers.

Note

VPOP *Registers* is equivalent to VLDM *sp!*, *Registers*.

You can use either form of this instruction. They both disassemble to VPOP.

Related concepts

[4.15 Stack implementation using LDM and STM on page 4-82.](#)

Related references

[11.8 Condition code suffixes on page 11-319.](#)

[13.11 VLDM \(floating-point\) on page 13-725.](#)

12.44 VLDR

Extension register load.

Syntax

`VLDR{cond}{.64} Dd, [Rn{, #offset}]`

`VLDR{cond}{.64} Dd, Label`

where:

cond

is an optional condition code.

Dd

is the extension register to be loaded.

Rn

is the ARM register holding the base address for the transfer.

offset

is an optional numeric expression. It must evaluate to a numeric value at assembly time. The value must be a multiple of 4, and lie in the range -1020 to $+1020$. The value is added to the base address to form the address used for the transfer.

Label

is a PC-relative expression.

Label must be aligned on a word boundary within $\pm 1\text{KB}$ of the current instruction.

Operation

The VLDR instruction loads an extension register from memory.

Two words are transferred.

There is also a VLDR pseudo-instruction.

Related concepts

[7.5 Register-relative and PC-relative expressions on page 7-142.](#)

Related references

[12.46 VLDR pseudo-instruction on page 12-625.](#)

[11.8 Condition code suffixes on page 11-319.](#)

[13.12 VLDR \(floating-point\) on page 13-726.](#)

12.45 VLDR (post-increment and pre-decrement)

Pseudo-instruction that loads extension registers, with post-increment and pre-decrement forms.

Note

There are also VLDR and VSTR instructions without post-increment and pre-decrement.

Syntax

VLDR{*cond*}{.64} *Dd*, [*Rn*], #*offset* ; post-increment

VLDR{*cond*}{.64} *Dd*, [*Rn*, #-*offset*]! ; pre-decrement

where:

cond

is an optional condition code.

Dd

is the extension register to load.

Rn

is the ARM register holding the base address for the transfer.

offset

is a numeric expression that must evaluate to 8 at assembly time.

Operation

The post-increment instruction increments the base address in the register by the offset value, after the transfer. The pre-decrement instruction decrements the base address in the register by the offset value, and then performs the transfer using the new address in the register. This pseudo-instruction assembles to a VLDM instruction.

Related references

[12.43 VLDM](#) on page 12-622.

[12.44 VLDR](#) on page 12-623.

[11.8 Condition code suffixes](#) on page 11-319.

[13.13 VLDR \(post-increment and pre-decrement, floating-point\)](#) on page 13-727.

12.46 VLDR pseudo-instruction

Pseudo-instruction that loads a constant value into every element of a 64-bit NEON vector.

Note

This section describes the VLDR pseudo-instruction only.

Syntax

`VLDR{cond}.datatype Dd,=constant`

where:

datatype

must be one of *In*, *Sn*, *Un*, or *F32*.

n

must be one of 8, 16, 32, or 64.

cond

is an optional condition code.

Dd

is the extension register to be loaded.

constant

is an immediate value of the appropriate type for *datatype*.

Operation

If an instruction (for example, `VMOV`) is available that can generate the constant directly into the register, the assembler uses it. Otherwise, the assembler generates a doubleword literal pool entry containing the constant and loads the constant using a `VLDR` instruction.

Related concepts

[8.9 NEON data types on page 8-177.](#)

Related references

[12.44 VLDR on page 12-623.](#)

[11.8 Condition code suffixes on page 11-319.](#)

[13.14 VLDR pseudo-instruction on page 13-728.](#)

12.47 VMAX and VMIN

Vector Maximum, Vector Minimum.

Syntax

Vop{*cond*}.*datatype* *Qd*, *Qn*, *Qm*

Vop{*cond*}.*datatype* *Dd*, *Dn*, *Dm*

where:

op

must be either MAX or MIN.

cond

is an optional condition code.

datatype

must be one of S8, S16, S32, U8, U16, U32, or F32.

Qd, *Qn*, *Qm*

are the destination vector, the first operand vector, and the second operand vector, for a quadword operation.

Dd, *Dn*, *Dm*

are the destination vector, the first operand vector, and the second operand vector, for a doubleword operation.

Operation

VMAX compares corresponding elements in two vectors, and copies the larger of each pair into the corresponding element in the destination vector.

VMIN compares corresponding elements in two vectors, and copies the smaller of each pair into the corresponding element in the destination vector.

Floating-point maximum and minimum

$\max(+0.0, -0.0) = +0.0$.

$\min(+0.0, -0.0) = -0.0$

If any input is a NaN, the corresponding result element is the default NaN.

Related concepts

[8.9 NEON data types on page 8-177.](#)

Related references

[12.78 VPADD on page 12-657.](#)

[11.8 Condition code suffixes on page 11-319.](#)

12.48 VMLA

Vector Multiply Accumulate.

Syntax

`VMLA{cond}.datatype {Qd}, Qn, Qm`

`VMLA{cond}.datatype {Dd}, Dn, Dm`

where:

cond

is an optional condition code.

datatype

must be one of I8, I16, I32, or F32.

Qd, Qn, Qm

are the destination vector, the first operand vector, and the second operand vector, for a quadword operation.

Dd, Dn, Dm

are the destination vector, the first operand vector, and the second operand vector, for a doubleword operation.

Operation

VMLA multiplies corresponding elements in two vectors, and accumulates the results into the elements of the destination vector.

Related concepts

[8.15 Polynomial arithmetic over {0,1}](#) on page 8-183.

[8.9 NEON data types](#) on page 8-177.

Related references

[11.8 Condition code suffixes](#) on page 11-319.

12.49 VMLA (by scalar)

Vector Multiply by scalar and Accumulate.

Syntax

`VMLA{cond}.datatype {Qd}, Qn, Dm[x]`

`VMLA{cond}.datatype {Dd}, Dn, Dm[x]`

where:

cond

is an optional condition code.

datatype

must be one of I16, I32, or F32.

Qd, Qn

are the destination vector and the first operand vector, for a quadword operation.

Dd, Dn

are the destination vector and the first operand vector, for a doubleword operation.

Dm[x]

is the scalar holding the second operand.

Operation

VMLA multiplies each element in a vector by a scalar, and accumulates the results into the corresponding elements of the destination vector.

Related concepts

[8.9 NEON data types on page 8-177.](#)

Related references

[11.8 Condition code suffixes on page 11-319.](#)

12.50 VMLAL (by scalar)

Vector Multiply by scalar and Accumulate Long.

Syntax

`VMLAL{cond}.datatype Qd, Dn, Dm[x]`

where:

cond

is an optional condition code.

datatype

must be one of S16, S32, U16, or U32

Qd, Dn

are the destination vector and the first operand vector, for a long operation.

Dm[x]

is the scalar holding the second operand.

Operation

VMLAL multiplies each element in a vector by a scalar, and accumulates the results into the corresponding elements of the destination vector.

Related concepts

[8.9 NEON data types on page 8-177.](#)

Related references

[11.8 Condition code suffixes on page 11-319.](#)

12.51 VMLAL

Vector Multiply Accumulate Long.

Syntax

`VMLAL{cond}.datatype Qd, Dn, Dm`

where:

cond

is an optional condition code.

datatype

must be one of S8, S16, S32, U8, U16, or U32.

Qd, Dn, Dm

are the destination vector, the first operand vector, and the second operand vector, for a long operation.

Operation

VMLAL multiplies corresponding elements in two vectors, and accumulates the results into the elements of the destination vector.

Related concepts

[8.15 Polynomial arithmetic over {0,1}](#) on page 8-183.

[8.9 NEON data types](#) on page 8-177.

Related references

[11.8 Condition code suffixes](#) on page 11-319.

12.52 VMLS (by scalar)

Vector Multiply by scalar and Subtract.

Syntax

VMLS{*cond*}.*datatype* {*Qd*}, *Qn*, *Dm*[*x*]

VMLS{*cond*}.*datatype* {*Dd*}, *Dn*, *Dm*[*x*]

where:

cond

is an optional condition code.

datatype

must be one of I16, I32, or F32.

Qd, *Qn*

are the destination vector and the first operand vector, for a quadword operation.

Dd, *Dn*

are the destination vector and the first operand vector, for a doubleword operation.

Dm[*x*]

is the scalar holding the second operand.

Operation

VMLS multiplies each element in a vector by a scalar, subtracts the results from the corresponding elements of the destination vector, and places the final results in the destination vector.

Related concepts

[8.9 NEON data types on page 8-177.](#)

Related references

[11.8 Condition code suffixes on page 11-319.](#)

12.53 VMLS

Vector Multiply Subtract.

Syntax

VMLS{*cond*}.datatype {*Qd*}, *Qn*, *Qm*

VMLS{*cond*}.datatype {*Dd*}, *Dn*, *Dm*

where:

cond

is an optional condition code.

datatype

must be one of I8, I16, I32, F32.

Qd, *Qn*, *Qm*

are the destination vector, the first operand vector, and the second operand vector, for a quadword operation.

Dd, *Dn*, *Dm*

are the destination vector, the first operand vector, and the second operand vector, for a doubleword operation.

Operation

VMLS multiplies corresponding elements in two vectors, subtracts the results from corresponding elements of the destination vector, and places the final results in the destination vector.

Related concepts

[8.15 Polynomial arithmetic over {0,1}](#) on page 8-183.

[8.9 NEON data types](#) on page 8-177.

Related references

[11.8 Condition code suffixes](#) on page 11-319.

12.54 VMLSL

Vector Multiply Subtract Long.

Syntax

`VMLSL{cond}.datatype Qd, Dn, Dm`

where:

cond

is an optional condition code.

datatype

must be one of S8, S16, S32, U8, U16, or U32.

Qd, Dn, Dm

are the destination vector, the first operand vector, and the second operand vector, for a long operation.

Operation

VMLSL multiplies corresponding elements in two vectors, subtracts the results from corresponding elements of the destination vector, and places the final results in the destination vector.

Related concepts

[8.15 Polynomial arithmetic over {0,1}](#) on page 8-183.

[8.9 NEON data types](#) on page 8-177.

Related references

[11.8 Condition code suffixes](#) on page 11-319.

12.55 VMLS (by scalar)

Vector Multiply by scalar and Subtract Long.

Syntax

`VMLS{cond}.datatype Qd, Dn, Dm[x]`

where:

cond

is an optional condition code.

datatype

must be one of S16, S32, U16, or U32.

Qd, Dn

are the destination vector and the first operand vector, for a long operation.

Dm[x]

is the scalar holding the second operand.

Operation

VMLS multiplies each element in a vector by a scalar, subtracts the results from the corresponding elements of the destination vector, and places the final results in the destination vector.

Related concepts

[8.9 NEON data types on page 8-177.](#)

Related references

[11.8 Condition code suffixes on page 11-319.](#)

12.56 VMOV (floating-point)

Insert a floating-point immediate value into a single-precision or double-precision register, or copy one register into another register. This instruction is always scalar.

Syntax

`VMOV{cond}.F32 Sd, #imm`

`VMOV{cond}.F64 Dd, #imm`

`VMOV{cond}.F32 Sd, Sm`

`VMOV{cond}.F64 Dd, Dm`

where:

cond

is an optional condition code.

Sd

is the single-precision destination register.

Dd

is the double-precision destination register.

imm

is the floating-point immediate value.

Sm

is the single-precision source register.

Dm

is the double-precision source register.

Immediate values

Any number that can be expressed as $\pm n * 2^{-r}$, where n and r are integers, $16 \leq n \leq 31$, $0 \leq r \leq 7$.

Architectures

The instructions that copy immediate constants are available in VFPv3 and above.

The instructions that copy from registers are available in all VFP systems.

Related references

[11.8 Condition code suffixes on page 11-319.](#)

[11.8 Condition code suffixes on page 11-319.](#)

12.57 VMOV (immediate)

Vector Move.

Syntax

VMOV{*cond*}.*datatype* *Qd*, #*imm*

VMOV{*cond*}.*datatype* *Dd*, #*imm*

where:

cond

is an optional condition code.

datatype

must be one of I8, I16, I32, I64, or F32.

Qd or *Dd*

is the NEON register for the result.

imm

is an immediate value of the type specified by *datatype*. This is replicated to fill the destination register.

Operation

VMOV replicates an immediate value in every element of the destination register.

Table 12-7 Available immediate values in VMOV (immediate)

datatype	imm
I8	0xXY
I16	0x00XY, 0xXY00
I32	0x000000XY, 0x0000XY00, 0x00XY0000, 0xXY000000
	0x0000XYFF, 0x00XYFFFF
I64	byte masks, 0xGGHHJJKKLLMMNNPP ^{ao}
F32	floating-point numbers ^{ap}

Related concepts

[8.9 NEON data types on page 8-177.](#)

Related references

[11.8 Condition code suffixes on page 11-319.](#)

^{ao} Each of 0xGG, 0xHH, 0xJJ, 0xKK, 0xLL, 0xMM, 0xNN, and 0xPP must be either 0x00 or 0xFF.
^{ap} Any number that can be expressed as $+/-n * 2^{-r}$, where n and r are integers, $16 \leq n \leq 31$, $0 \leq r \leq 7$.

12.58 VMOV (register)

Vector Move.

Syntax

VMOV{*cond*}{*.datatype*} *Qd*, *Qm*

VMOV{*cond*}{*.datatype*} *Dd*, *Dm*

where:

cond

is an optional condition code.

datatype

is an optional datatype. The assembler ignores *datatype*.

Qd, *Qm*

specifies the destination vector and the source vector, for a quadword operation.

Dd, *Dm*

specifies the destination vector and the source vector, for a doubleword operation.

Operation

VMOV copies the contents of the source register into the destination register.

Related references

[11.8 Condition code suffixes on page 11-319.](#)

12.59 VMOV (between two ARM registers and a 64-bit extension register)

Transfer contents between two ARM registers and a 64-bit extension register.

Syntax

VMOV{*cond*} *Dm*, *Rd*, *Rn*

VMOV{*cond*} *Rd*, *Rn*, *Dm*

where:

cond

is an optional condition code.

Dm

is a 64-bit extension register.

Rd, *Rn*

are the ARM registers. *Rd* and *Rn* must not be PC.

Operation

VMOV *Dm*, *Rd*, *Rn* transfers the contents of *Rd* into the low half of *Dm*, and the contents of *Rn* into the high half of *Dm*.

VMOV *Rd*, *Rn*, *Dm* transfers the contents of the low half of *Dm* into *Rd*, and the contents of the high half of *Dm* into *Rn*.

Related references

[11.8 Condition code suffixes on page 11-319.](#)

12.60 VMOV (between an ARM register and a NEON scalar)

Transfer contents between an ARM register and a NEON scalar.

Syntax

VMOV{*cond*}{*.size*} *Dn[x]*, *Rd*

VMOV{*cond*}{*.datatype*} *Rd*, *Dn[x]*

where:

cond

is an optional condition code.

size

the data size. Can be 8, 16, or 32. If omitted, *size* is 32.

datatype

the data type. Can be U8, S8, U16, S16, or 32. If omitted, *datatype* is 32.

Dn[x]

is the NEON scalar.

Rd

is the ARM register. *Rd* must not be PC.

Operation

VMOV *Dn[x]*, *Rd* transfers the contents of the least significant byte, halfword, or word of *Rd* into *Dn[x]*.

VMOV *Rd*, *Dn[x]* transfers the contents of *Dn[x]* into the least significant byte, halfword, or word of *Rd*. The remaining bits of *Rd* are either zero or sign extended.

Related concepts

[8.14 NEON scalars](#) on page 8-182.

[8.9 NEON data types](#) on page 8-177.

Related references

[11.8 Condition code suffixes](#) on page 11-319.

12.61 VMOVL

Vector Move Long.

Syntax

VMOVL{*cond*}.*datatype* *Qd*, *Dm*

where:

cond

is an optional condition code.

datatype

must be one of S8, S16, S32, U8, U16, or U32.

Qd, *Dm*

specifies the destination vector and the operand vector.

Operation

VMOVL takes each element in a doubleword vector, sign or zero extends them to twice their original length, and places the results in a quadword vector.

Related concepts

[8.9 NEON data types on page 8-177.](#)

Related references

[11.8 Condition code suffixes on page 11-319.](#)

12.62 VMOVN

Vector Move and Narrow.

Syntax

VMOVN{*cond*}.*datatype* *Dd*, *Qm*

where:

cond

is an optional condition code.

datatype

must be one of I16, I32, or I64.

Dd, *Qm*

specifies the destination vector and the operand vector.

Operation

VMOVN copies the least significant half of each element of a quadword vector into the corresponding elements of a doubleword vector.

Related concepts

[8.9 NEON data types on page 8-177.](#)

Related references

[11.8 Condition code suffixes on page 11-319.](#)

12.63 VMOV2

Pseudo-instruction that generates an immediate value and places it in every element of a NEON vector, without loading a value from a literal pool.

Syntax

`VMOV2{cond}.datatype Qd, #constant`

`VMOV2{cond}.datatype Dd, #constant`

where:

datatype

must be one of:

- I8, I16, I32, or I64.
- S8, S16, S32, or S64.
- U8, U16, U32, or U64.
- F32.

cond

is an optional condition code.

Qd or *Dd*

is the extension register to be loaded.

constant

is an immediate value of the appropriate type for *datatype*.

Operation

VMOV2 can generate any 16-bit immediate value, and a restricted range of 32-bit and 64-bit immediate values.

VMOV2 is a pseudo-instruction that always assembles to exactly two instructions. It typically assembles to a VMOV or VMVN instruction, followed by a VBIC or VORR instruction.

Related concepts

[8.9 NEON data types](#) on page 8-177.

Related references

[12.57 VMOV \(immediate\)](#) on page 12-636.

[12.14 VBIC \(immediate\)](#) on page 12-590.

[11.8 Condition code suffixes](#) on page 11-319.

12.64 VMRS

Transfer the contents of a NEON system register to an ARM register.

Syntax

```
VMRS{cond} Rd, extsysreg
```

where:

cond

is an optional condition code.

extsysreg

is the NEON system register, usually FPSCR, FPSID, or FPEXC.

Rd

is the ARM register. *Rd* must not be PC.

It can be `APSR_nzcv`, if *extsysreg* is FPSCR. In this case, the floating-point status flags are transferred into the corresponding flags in the ARM APSR.

Operation

The VMRS instruction transfers the contents of *extsysreg* into *Rd*.

————— **Note** —————

This instruction stalls the processor until all current NEON operations complete.

Examples

```
VMRS    r2, FPCID
VMRS    APSR_nzcv, FPSCR ; transfer FP status register to ARM APSR
```

Related references

[8.16 NEON system registers](#) on page 8-184.

[11.8 Condition code suffixes](#) on page 11-319.

[13.21 VMRS](#) on page 13-735.

12.65 VMSR

Transfer the contents of an ARM register to a NEON system register.

Syntax

VMSR{*cond*} *extsysreg*, *Rd*

where:

cond

is an optional condition code.

extsysreg

is the NEON system register, usually FPSCR, FPSID, or FPEXC.

Rd

is the ARM register. *Rd* must not be PC.

Operation

The VMSR instruction transfers the contents of *Rd* into *extsysreg*.

Note

This instruction stalls the processor until all current NEON operations complete.

Example

```
VMSR    FPSCR, r4
```

Related references

[8.16 NEON system registers](#) on page 8-184.

[11.8 Condition code suffixes](#) on page 11-319.

[13.22 VMSR](#) on page 13-736.

12.66 VMUL

Vector Multiply.

Syntax

`VMUL{cond}.datatype {Qd}, Qn, Qm`

`VMUL{cond}.datatype {Dd}, Dn, Dm`

where:

cond

is an optional condition code.

datatype

must be one of I8, I16, I32, F32, or P8.

Qd, Qn, Qm

are the destination vector, the first operand vector, and the second operand vector, for a quadword operation.

Dd, Dn, Dm

are the destination vector, the first operand vector, and the second operand vector, for a doubleword operation.

Operation

VMUL multiplies corresponding elements in two vectors, and places the results in the destination vector.

Related concepts

[8.15 Polynomial arithmetic over {0,1}](#) on page 8-183.

[8.9 NEON data types](#) on page 8-177.

Related references

[11.8 Condition code suffixes](#) on page 11-319.

12.67 VMUL (by scalar)

Vector Multiply by scalar.

Syntax

`VMUL{cond}.datatype {Qd}, Qn, Dm[x]`

`VMUL{cond}.datatype {Dd}, Dn, Dm[x]`

where:

cond

is an optional condition code.

datatype

must be one of I16, I32, or F32.

Qd, Qn

are the destination vector and the first operand vector, for a quadword operation.

Dd, Dn

are the destination vector and the first operand vector, for a doubleword operation.

Dm[x]

is the scalar holding the second operand.

Operation

VMUL multiplies each element in a vector by a scalar, and places the results in the destination vector.

Related concepts

[8.9 NEON data types on page 8-177.](#)

Related references

[11.8 Condition code suffixes on page 11-319.](#)

12.68 VMULL

Vector Multiply Long

Syntax

`VMULL{cond}.datatype Qd, Dn, Dm`

where:

cond

is an optional condition code.

datatype

must be one of U8, U16, U32, S8, S16, S32, or P8.

Qd, Dn, Dm

are the destination vector, the first operand vector, and the second operand vector, for a long operation.

Operation

VMULL multiplies corresponding elements in two vectors, and places the results in the destination vector.

Related concepts

[8.15 Polynomial arithmetic over {0,1}](#) on page 8-183.

[8.9 NEON data types](#) on page 8-177.

Related references

[11.8 Condition code suffixes](#) on page 11-319.

12.69 VMULL (by scalar)

Vector Multiply Long by scalar

Syntax

`VMULL{cond}.datatype Qd, Dn, Dm[x]`

where:

cond

is an optional condition code.

datatype

must be one of S16, S32, U16, or U32.

Qd, Dn

are the destination vector and the first operand vector, for a long operation.

Dm[x]

is the scalar holding the second operand.

Operation

VMULL multiplies each element in a vector by a scalar, and places the results in the destination vector.

Related concepts

[8.9 NEON data types on page 8-177.](#)

Related references

[11.8 Condition code suffixes on page 11-319.](#)

12.70 VMVN (register)

Vector Move NOT (register).

Syntax

`VMVN{cond}{.datatype} Qd, Qm`

`VMVN{cond}{.datatype} Dd, Dm`

where:

cond

is an optional condition code.

datatype

is an optional datatype. The assembler ignores *datatype*.

Qd, *Qm*

specifies the destination vector and the source vector, for a quadword operation.

Dd, *Dm*

specifies the destination vector and the source vector, for a doubleword operation.

Operation

VMVN inverts the value of each bit from the source register and places the results into the destination register.

Related references

[11.8 Condition code suffixes on page 11-319.](#)

12.71 VMVN (immediate)

Vector Move NOT (immediate).

Syntax

`VMVN{cond}.datatype Qd, #imm`

`VMVN{cond}.datatype Dd, #imm`

where:

cond

is an optional condition code.

datatype

must be one of I8, I16, I32, I64, or F32.

Qd or *Dd*

is the NEON register for the result.

imm

is an immediate value of the type specified by *datatype*. This is replicated to fill the destination register.

Operation

VMVN inverts the value of each bit from an immediate value and places the results into each element in the destination register.

Table 12-8 Available immediate values in VMVN (immediate)

datatype	imm
I8	-
I16	0xFFXY, 0xXYFF
I32	0xFFFFFFFFXY, 0xFFFFFFFFYF, 0xFFXYFFFF, 0xXYFFFFFFF
	0xFFFFFFFFY0, 0xFFXY0000
I64	-
F32	-

Related concepts

[8.9 NEON data types](#) on page 8-177.

Related references

[11.8 Condition code suffixes](#) on page 11-319.

12.72 VNEG

Vector Negate.

Syntax

VNEG{*cond*}.*datatype* *Qd*, *Qm*

VNEG{*cond*}.*datatype* *Dd*, *Dm*

where:

cond

is an optional condition code.

datatype

must be one of S8, S16, S32, or F32.

Qd, *Qm*

are the destination vector and the operand vector, for a quadword operation.

Dd, *Dm*

are the destination vector and the operand vector, for a doubleword operation.

Operation

VNEG negates each element in a vector, and places the results in a second vector. (The floating-point version only inverts the sign bit.)

Related concepts

[8.9 NEON data types](#) on page 8-177.

Related references

[13.24 VNEG \(floating-point\)](#) on page 13-738.

[11.8 Condition code suffixes](#) on page 11-319.

12.73 VORN (register)

Vector bitwise OR NOT (register).

Syntax

VORN{*cond*}{*.datatype*} {*Qd*}, *Qn*, *Qm*

VORN{*cond*}{*.datatype*} {*Dd*}, *Dn*, *Dm*

where:

cond

is an optional condition code.

datatype

is an optional data type. The assembler ignores *datatype*.

Qd, *Qn*, *Qm*

specifies the destination register, the first operand register, and the second operand register, for a quadword operation.

Dd, *Dn*, *Dm*

specifies the destination register, the first operand register, and the second operand register, for a doubleword operation.

Operation

VORN performs a bitwise logical OR complement between two registers, and places the results in the destination register.

Related references

[11.8 Condition code suffixes on page 11-319.](#)

12.74 VORN (immediate)

Vector bitwise OR NOT (immediate) pseudo-instruction.

Syntax

VORN{*cond*}.*datatype* *Qd*, #*imm*

VORN{*cond*}.*datatype* *Dd*, #*imm*

where:

cond

is an optional condition code.

datatype

must be either I8, I16, I32, or I64.

Qd or *Dd*

is the NEON register for the result.

imm

is the immediate value.

Operation

VORN takes each element of the destination vector, performs a bitwise OR complement with an immediate value, and returns the results in the destination vector.

Note

On disassembly, this pseudo-instruction is disassembled to a corresponding VORR instruction, with a complementary immediate value.

Immediate values

If *datatype* is I16, the immediate value must have one of the following forms:

- 0xFFXY.
- 0xXYFF.

If *datatype* is I32, the immediate value must have one of the following forms:

- 0xFFFFFFXY.
- 0xFFFFXYFF.
- 0xFFXYFFFF.
- 0XYFFFFFFF.

Related concepts

[8.9 NEON data types](#) on page 8-177.

Related references

[12.14 VBIC \(immediate\)](#) on page 12-590.

[11.8 Condition code suffixes](#) on page 11-319.

12.75 VORR (register)

Vector bitwise OR (register).

Syntax

VORR{*cond*}{*.datatype*} {*Qd*}, *Qn*, *Qm*

VORR{*cond*}{*.datatype*} {*Dd*}, *Dn*, *Dm*

where:

cond

is an optional condition code.

datatype

is an optional data type. The assembler ignores *datatype*.

Qd, *Qn*, *Qm*

specifies the destination register, the first operand register, and the second operand register, for a quadword operation.

Dd, *Dn*, *Dm*

specifies the destination register, the first operand register, and the second operand register, for a doubleword operation.

Note

VORR with the same register for both operands is a VMOV instruction. You can use VORR in this way, but disassembly of the resulting code produces the VMOV syntax.

Operation

VORR performs a bitwise logical OR between two registers, and places the result in the destination register.

Related references

[12.58 VMOV \(register\) on page 12-637.](#)

[11.8 Condition code suffixes on page 11-319.](#)

12.76 VORR (immediate)

Vector bitwise OR immediate.

Syntax

VORR{*cond*}.datatype *Qd*, #*imm*

VORR{*cond*}.datatype *Dd*, #*imm*

where:

cond

is an optional condition code.

datatype

must be either I8, I16, I32, or I64.

Qd or *Dd*

is the NEON register for the source and result.

imm

is the immediate value.

Operation

VORR takes each element of the destination vector, performs a bitwise logical OR with an immediate value, and places the results in the destination vector.

Immediate values

You can either specify *imm* as a pattern which the assembler repeats to fill the destination register, or you can directly specify the immediate value (that conforms to the pattern) in full. The pattern for *imm* depends on the datatype, as shown in the following table:

Table 12-9 Patterns for immediate value in VORR (immediate)

I16	I32
0x00XY	0x000000XY
0xXY00	0x0000XY00
-	0x00XY0000
-	0xXY000000

If you use the I8 or I64 datatypes, the assembler converts it to either the I16 or I32 instruction to match the pattern of *imm*. If the immediate value does not match any of the patterns in the preceding table, the assembler generates an error.

Related concepts

[8.9 NEON data types on page 8-177.](#)

Related references

[12.12 VAND \(immediate\) on page 12-588.](#)

[11.8 Condition code suffixes on page 11-319.](#)

12.77 VPADAL

Vector Pairwise Add and Accumulate Long.

Syntax

`VPADAL{cond}.datatype Qd, Qm`

`VPADAL{cond}.datatype Dd, Dm`

where:

cond

is an optional condition code.

datatype

must be one of S8, S16, S32, U8, U16, or U32.

Qd, Qm

are the destination vector and the operand vector, for a quadword instruction.

Dd, Dm

are the destination vector and the operand vector, for a doubleword instruction.

Operation

VPADAL adds adjacent pairs of elements of a vector, and accumulates the absolute values of the results into the elements of the destination vector.

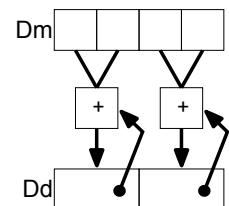

Figure 12-3 Example of operation of VPADAL (in this case for data type S16)

Related concepts

[8.9 NEON data types](#) on page 8-177.

Related references

[11.8 Condition code suffixes](#) on page 11-319.

12.78 VPADD

Vector Pairwise Add.

Syntax

`VPADD{cond}.datatype {Dd}, Dn, Dm`

where:

cond

is an optional condition code.

datatype

must be one of I8, I16, I32, or F32.

Dd, Dn, Dm

are the destination vector, the first operand vector, and the second operand vector.

Operation

VPADD adds adjacent pairs of elements of two vectors, and places the results in the destination vector.

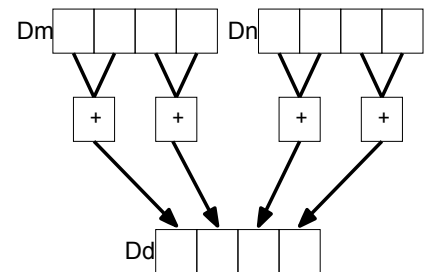

Figure 12-4 Example of operation of VPADD (in this case, for data type I16)

Related concepts

[8.9 NEON data types](#) on page 8-177.

Related references

[11.8 Condition code suffixes](#) on page 11-319.

12.79 VPADDL

Vector Pairwise Add Long.

Syntax

`VPADDL{cond}.datatype Qd, Qm`

`VPADDL{cond}.datatype Dd, Dm`

where:

cond

is an optional condition code.

datatype

must be one of S8, S16, S32, U8, U16, or U32.

Qd, Qm

are the destination vector and the operand vector, for a quadword instruction.

Dd, Dm

are the destination vector and the operand vector, for a doubleword instruction.

Operation

VPADDL adds adjacent pairs of elements of a vector, sign or zero extends the results to twice their original width, and places the final results in the destination vector.

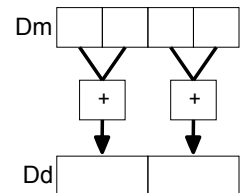

Figure 12-5 Example of operation of doubleword VPADDL (in this case, for data type S16)

Related concepts

[8.9 NEON data types](#) on page 8-177.

Related references

[11.8 Condition code suffixes](#) on page 11-319.

12.80 VPMAX and VPMIN

Vector Pairwise Maximum, Vector Pairwise Minimum.

Syntax

$VPop\{cond\}.datatype\ Dd, Dn, Dm$

where:

op

must be either MAX or MIN.

cond

is an optional condition code.

datatype

must be one of S8, S16, S32, U8, U16, U32, or F32.

Dd, Dn, Dm

are the destination doubleword vector, the first operand doubleword vector, and the second operand doubleword vector.

Operation

VPMAX compares adjacent pairs of elements in two vectors, and copies the larger of each pair into the corresponding element in the destination vector. Operands and results must be doubleword vectors.

VPMIN compares adjacent pairs of elements in two vectors, and copies the smaller of each pair into the corresponding element in the destination vector. Operands and results must be doubleword vectors.

Floating-point maximum and minimum

$\max(+0.0, -0.0) = +0.0$.

$\min(+0.0, -0.0) = -0.0$

If any input is a NaN, the corresponding result element is the default NaN.

Related concepts

[8.9 NEON data types on page 8-177.](#)

Related references

[12.78 VPADD on page 12-657.](#)

[11.8 Condition code suffixes on page 11-319.](#)

12.81 VPOP

Pop extension registers from the stack.

Syntax

VPOP{*cond*} *Registers*

where:

cond

is an optional condition code.

Registers

is a list of consecutive extension registers enclosed in braces, { and }. The list can be comma-separated, or in range format. There must be at least one register in the list.

You can specify D or Q registers, but they must not be mixed. The number of registers must not exceed 16 D registers, or 8 Q registers. If Q registers are specified, on disassembly they are shown as D registers.

Note

VPOP *Registers* is equivalent to VLDM *sp!*, *Registers*.

You can use either form of this instruction. They both disassemble to VPOP.

Related concepts

[4.15 Stack implementation using LDM and STM](#) on page 4-82.

Related references

[11.8 Condition code suffixes](#) on page 11-319.

[12.82 VPUSH](#) on page 12-661.

[13.28 VPOP \(floating-point\)](#) on page 13-742.

12.82 VPUSH

Push extension registers onto the stack.

Syntax

`VPUSH{cond} Registers`

where:

cond

is an optional condition code.

Registers

is a list of consecutive extension registers enclosed in braces, { and }. The list can be comma-separated, or in range format. There must be at least one register in the list.

You can specify D or Q registers, but they must not be mixed. The number of registers must not exceed 16 D registers, or 8 Q registers. If Q registers are specified, on disassembly they are shown as D registers.

Note

`VPUSH Registers` is equivalent to `VSTMDB sp!, Registers`.

You can use either form of this instruction. They both disassemble to `VPUSH`.

Related concepts

[4.15 Stack implementation using LDM and STM](#) on page 4-82.

Related references

[11.8 Condition code suffixes](#) on page 11-319.

[12.81 VPOP](#) on page 12-660.

[13.29 VPUSH \(floating-point\)](#) on page 13-743.

12.83 VQABS

Vector Saturating Absolute.

Syntax

VQABS{*cond*}.*datatype* *Qd*, *Qm*

VQABS{*cond*}.*datatype* *Dd*, *Dm*

where:

cond

is an optional condition code.

datatype

must be one of S8, S16, or S32.

Qd, *Qm*

are the destination vector and the operand vector, for a quadword operation.

Dd, *Dm*

are the destination vector and the operand vector, for a doubleword operation.

Operation

VQABS takes the absolute value of each element in a vector, and places the results in a second vector.

The sticky QC flag (FPSCR bit[27]) is set if saturation occurs.

Related concepts

[8.9 NEON data types](#) on page 8-177.

Related references

[11.8 Condition code suffixes](#) on page 11-319.

12.84 VQADD

Vector Saturating Add.

Syntax

VQADD{*cond*}.*datatype* {*Qd*}, *Qn*, *Qm*

VQADD{*cond*}.*datatype* {*Dd*}, *Dn*, *Dm*

where:

cond

is an optional condition code.

datatype

must be one of S8, S16, S32, S64, U8, U16, U32, or U64.

Qd, *Qn*, *Qm*

are the destination vector, the first operand vector, and the second operand vector, for a quadword operation.

Dd, *Dn*, *Dm*

are the destination vector, the first operand vector, and the second operand vector, for a doubleword operation.

Operation

VQADD adds corresponding elements in two vectors, and places the results in the destination vector.

The sticky QC flag (FPSCR bit[27]) is set if saturation occurs.

Related concepts

[8.9 NEON data types on page 8-177.](#)

Related references

[11.8 Condition code suffixes on page 11-319.](#)

12.85 VQDMLAL and VQDMLSL (by vector or by scalar)

Vector Saturating Doubling Multiply Accumulate Long, Vector Saturating Doubling Multiply Subtract Long.

Syntax

$VQDopL\{cond\}.datatype\ Qd, Dn, Dm$

$VQDopL\{cond\}.datatype\ Qd, Dn, Dm[x]$

where:

op

must be one of:

MLA

Multiply Accumulate.

MLS

Multiply Subtract.

cond

is an optional condition code.

datatype

must be either S16 or S32.

Qd, Dn

are the destination vector and the first operand vector.

Dm

is the vector holding the second operand, for a *by vector* operation.

Dm[x]

is the scalar holding the second operand, for a *by scalar* operation.

Operation

These instructions multiply their operands and double the results. VQDMLAL adds the results to the values in the destination register. VQDMLSL subtracts the results from the values in the destination register.

If any of the results overflow, they are saturated. The sticky QC flag (FPSCR bit[27]) is set if saturation occurs.

Related concepts

[8.9 NEON data types on page 8-177.](#)

Related references

[11.8 Condition code suffixes on page 11-319.](#)

12.86 VQDMULH (by vector or by scalar)

Vector Saturating Doubling Multiply Returning High Half.

Syntax

VQDMULH{*cond*}.datatype {*Qd*}, *Qn*, *Qm*

VQDMULH{*cond*}.datatype {*Dd*}, *Dn*, *Dm*

VQDMULH{*cond*}.datatype {*Qd*}, *Qn*, *Dm*[*x*]

VQDMULH{*cond*}.datatype {*Dd*}, *Dn*, *Dm*[*x*]

where:

cond

is an optional condition code.

datatype

must be either S16 or S32.

Qd, *Qn*

are the destination vector and the first operand vector, for a quadword operation.

Dd, *Dn*

are the destination vector and the first operand vector, for a doubleword operation.

Qm or *Dm*

is the vector holding the second operand, for a *by vector* operation.

Dm[*x*]

is the scalar holding the second operand, for a *by scalar* operation.

Operation

VQDMULH multiplies corresponding elements in two vectors, doubles the results, and places the most significant half of the final results in the destination vector.

The second operand can be a scalar instead of a vector.

If any of the results overflow, they are saturated. The sticky QC flag (FPSCR bit[27]) is set if saturation occurs. Each result is truncated.

Related concepts

[8.9 NEON data types on page 8-177.](#)

Related references

[11.8 Condition code suffixes on page 11-319.](#)

12.87 VQDMULL (by vector or by scalar)

Vector Saturating Doubling Multiply Long.

Syntax

VQDMULL{*cond*}.*datatype* *Qd*, *Dn*, *Dm*

VQDMULL{*cond*}.*datatype* *Qd*, *Dn*, *Dm*[*x*]

where:

cond

is an optional condition code.

datatype

must be either S16 or S32.

Qd, *Dn*

are the destination vector and the first operand vector.

Dm

is the vector holding the second operand, for a *by vector* operation.

Dm[*x*]

is the scalar holding the second operand, for a *by scalar* operation.

Operation

VQDMULL multiplies corresponding elements in two vectors, doubles the results and places the results in the destination register.

The second operand can be a scalar instead of a vector.

If any of the results overflow, they are saturated. The sticky QC flag (FPSCR bit[27]) is set if saturation occurs.

Related concepts

[8.9 NEON data types on page 8-177.](#)

Related references

[11.8 Condition code suffixes on page 11-319.](#)

12.88 VQMOVN and VQMOVUN

Vector Saturating Move and Narrow.

Syntax

VQMOVN{*cond*}.*datatype* *Dd*, *Qm*

VQMOVUN{*cond*}.*datatype* *Dd*, *Qm*

where:

cond

is an optional condition code.

datatype

must be one of:

S16, S32, S64

for VQMOVN or VQMOVUN.

U16, U32, U64

for VQMOVN.

Dd, *Qm*

specifies the destination vector and the operand vector.

Operation

VQMOVN copies each element of the operand vector to the corresponding element of the destination vector. The result element is half the width of the operand element, and values are saturated to the result width. The results are the same type as the operands.

VQMOVUN copies each element of the operand vector to the corresponding element of the destination vector. The result element is half the width of the operand element, and values are saturated to the result width. The elements in the operand are signed and the elements in the result are unsigned.

Related concepts

[8.9 NEON data types on page 8-177.](#)

Related references

[11.8 Condition code suffixes on page 11-319.](#)

12.89 VQNEG

Vector Saturating Negate.

Syntax

VQNEG{*cond*}.*datatype* *Qd*, *Qm*

VQNEG{*cond*}.*datatype* *Dd*, *Dm*

where:

cond

is an optional condition code.

datatype

must be one of S8, S16, or S32.

Qd, *Qm*

are the destination vector and the operand vector, for a quadword operation.

Dd, *Dm*

are the destination vector and the operand vector, for a doubleword operation.

Operation

VQNEG negates each element in a vector, and places the results in a second vector.

The sticky QC flag (FPSCR bit[27]) is set if saturation occurs.

Related concepts

[8.9 NEON data types](#) on page 8-177.

Related references

[11.8 Condition code suffixes](#) on page 11-319.

12.90 VQRDMULH (by vector or by scalar)

Vector Saturating Rounding Doubling Multiply Returning High Half.

Syntax

VQRDMULH{*cond*}.datatype {*Qd*}, *Qn*, *Qm*

VQRDMULH{*cond*}.datatype {*Dd*}, *Dn*, *Dm*

VQRDMULH{*cond*}.datatype {*Qd*}, *Qn*, *Dm*[*x*]

VQRDMULH{*cond*}.datatype {*Dd*}, *Dn*, *Dm*[*x*]

where:

cond

is an optional condition code.

datatype

must be either S16 or S32.

Qd, *Qn*

are the destination vector and the first operand vector, for a quadword operation.

Dd, *Dn*

are the destination vector and the first operand vector, for a doubleword operation.

Qm or *Dm*

is the vector holding the second operand, for a *by vector* operation.

Dm[*x*]

is the scalar holding the second operand, for a *by scalar* operation.

Operation

VQRDMULH multiplies corresponding elements in two vectors, doubles the results, and places the most significant half of the final results in the destination vector.

The second operand can be a scalar instead of a vector.

If any of the results overflow, they are saturated. The sticky QC flag (FPSCR bit[27]) is set if saturation occurs. Each result is rounded.

Related concepts

[8.9 NEON data types on page 8-177.](#)

Related references

[11.8 Condition code suffixes on page 11-319.](#)

12.91 VQRSHL (by signed variable)

Vector Saturating Rounding Shift Left by signed variable.

Syntax

VQRSHL{*cond*}.*datatype* {*Qd*}, *Qm*, *Qn*

VQRSHL{*cond*}.*datatype* {*Dd*}, *Dm*, *Dn*

where:

cond

is an optional condition code.

datatype

must be one of S8, S16, S32, S64, U8, U16, U32, or U64.

Qd, *Qm*, *Qn*

are the destination vector, the first operand vector, and the second operand vector, for a quadword operation.

Dd, *Dm*, *Dn*

are the destination vector, the first operand vector, and the second operand vector, for a doubleword operation.

Operation

VQRSHL takes each element in a vector, shifts them by a value from the least significant byte of the corresponding element of a second vector, and places the results in the destination vector. If the shift value is positive, the operation is a left shift. Otherwise, it is a rounding right shift.

The sticky QC flag (FPSCR bit[27]) is set if saturation occurs.

Related concepts

[8.9 NEON data types on page 8-177.](#)

Related references

[11.8 Condition code suffixes on page 11-319.](#)

12.92 VQRSHRN and VQRSHRUN (by immediate)

Vector Saturating Shift Right, Narrow, by immediate value, with Rounding.

Syntax

VQRSHR{U}N{cond}.datatype Dd, Qm, #imm

where:

U

if present, indicates that the results are unsigned, although the operands are signed. Otherwise, the results are the same type as the operands.

cond

is an optional condition code.

datatype

must be one of:

I16, I32, I64

for VQRSHRN or VQRSHRUN. Only a #0 immediate is permitted with these datatypes.

S16, S32, S64

for VQRSHRN or VQRSHRUN.

U16, U32, U64

for VQRSHRN only.

Dd, Qm

are the destination vector and the operand vector.

imm

is the immediate value specifying the size of the shift. The ranges are shown in the following table:

Table 12-10 Available immediate ranges in VQRSHRN and VQRSHRUN (by immediate)

datatype	imm range
S16 or U16	0 to 8
S32 or U32	0 to 16
S64 or U64	0 to 32

Operation

VQRSHR{U}N takes each element in a quadword vector of integers, right shifts them by an immediate value, and places the results in a doubleword vector.

The sticky QC flag (FPSCR bit[27]) is set if saturation occurs.

Results are rounded.

Related concepts

[8.9 NEON data types on page 8-177.](#)

Related references

[11.8 Condition code suffixes on page 11-319.](#)

12.93 VQSHL (by signed variable)

Vector Saturating Shift Left by signed variable.

Syntax

VQSHL{*cond*}.*datatype* {*Qd*}, *Qm*, *Qn*

VQSHL{*cond*}.*datatype* {*Dd*}, *Dm*, *Dn*

where:

cond

is an optional condition code.

datatype

must be one of S8, S16, S32, S64, U8, U16, U32, or U64.

Qd, *Qm*, *Qn*

are the destination vector, the first operand vector, and the second operand vector, for a quadword operation.

Dd, *Dm*, *Dn*

are the destination vector, the first operand vector, and the second operand vector, for a doubleword operation.

Operation

VQSHL takes each element in a vector, shifts them by a value from the least significant byte of the corresponding element of a second vector, and places the results in the destination vector. If the shift value is positive, the operation is a left shift. Otherwise, it is a truncating right shift.

The sticky QC flag (FPSCR bit[27]) is set if saturation occurs.

Related concepts

[8.9 NEON data types on page 8-177.](#)

Related references

[11.8 Condition code suffixes on page 11-319.](#)

12.94 VQSHL and VQSHLU (by immediate)

Vector Saturating Shift Left.

Syntax

VQSHL{U}{*cond*}.datatype {*Qd*}, *Qm*, #*imm*

VQSHL{U}{*cond*}.datatype {*Dd*}, *Dm*, #*imm*

where:

U

only permitted if Q is also present. Indicates that the results are unsigned even though the operands are signed.

cond

is an optional condition code.

datatype

must be one of :

S8, S16, S32, S64

for VQSHL or VQSHLU.

U8, U16, U32, U64

for VQSHL only.

Qd, Qm

are the destination and operand vectors, for a quadword operation.

Dd, Dm

are the destination and operand vectors, for a doubleword operation.

imm

is the immediate value specifying the size of the shift, in the range 0 to (size(*datatype*) – 1). The ranges are shown in the following table:

Table 12-11 Available immediate ranges in VQSHL and VQSHLU (by immediate)

datatype	imm range
S8 or U8	0 to 7
S16 or U16	0 to 15
S32 or U32	0 to 31
S64 or U64	0 to 63

Operation

VQSHL and VQSHLU instructions take each element in a vector of integers, left shift them by an immediate value, and place the results in the destination vector.

The sticky QC flag (FPSCR bit[27]) is set if saturation occurs.

Related concepts

[8.9 NEON data types on page 8-177.](#)

Related references

[11.8 Condition code suffixes on page 11-319.](#)

12.95 VQSHRN and VQSHRUN (by immediate)

Vector Saturating Shift Right, Narrow, by immediate value.

Syntax

VQSHR{U}N{*cond*}.datatype *Dd*, *Qm*, #*imm*

where:

U

if present, indicates that the results are unsigned, although the operands are signed. Otherwise, the results are the same type as the operands.

cond

is an optional condition code.

datatype

must be one of:

I16, I32, I64

for VQSHRN or VQSHRUN. Only a #0 immediate is permitted with these datatypes.

S16, S32, S64

for VQSHRN or VQSHRUN.

U16, U32, U64

for VQSHRN only.

Dd, *Qm*

are the destination vector and the operand vector.

imm

is the immediate value specifying the size of the shift. The ranges are shown in the following table:

Table 12-12 Available immediate ranges in VQSHRN and VQSHRUN (by immediate)

datatype	imm range
S16 or U16	0 to 8
S32 or U32	0 to 16
S64 or U64	0 to 32

Operation

VQSHR{U}N takes each element in a quadword vector of integers, right shifts them by an immediate value, and places the results in a doubleword vector.

The sticky QC flag (FPSCR bit[27]) is set if saturation occurs.

Results are truncated.

Related concepts

[8.9 NEON data types on page 8-177.](#)

Related references

[11.8 Condition code suffixes on page 11-319.](#)

12.96 VQSUB

Vector Saturating Subtract.

Syntax

VQSUB{*cond*}.*datatype* {*Qd*}, *Qn*, *Qm*

VQSUB{*cond*}.*datatype* {*Dd*}, *Dn*, *Dm*

where:

cond

is an optional condition code.

datatype

must be one of S8, S16, S32, S64, U8, U16, U32, or U64.

Qd, *Qn*, *Qm*

are the destination vector, the first operand vector, and the second operand vector, for a quadword operation.

Dd, *Dn*, *Dm*

are the destination vector, the first operand vector, and the second operand vector, for a doubleword operation.

Operation

VQSUB subtracts the elements of one vector from the corresponding elements of another vector, and places the results in the destination vector.

The sticky QC flag (FPSCR bit[27]) is set if saturation occurs.

Related concepts

[8.9 NEON data types](#) on page 8-177.

Related references

[11.8 Condition code suffixes](#) on page 11-319.

12.97 VRADDHN

Vector Rounding Add and Narrow, selecting High half.

Syntax

`VRADDHN{cond}.datatype Dd, Qn, Qm`

where:

cond

is an optional condition code.

datatype

must be one of I16, I32, or I64.

Dd, *Qn*, *Qm*

are the destination vector, the first operand vector, and the second operand vector.

Operation

VRADDHN adds corresponding elements in two quadword vectors, selects the most significant halves of the results, and places the final results in the destination doubleword vector. Results are rounded.

Related concepts

[8.9 NEON data types on page 8-177.](#)

Related references

[11.8 Condition code suffixes on page 11-319.](#)

12.98 VRECPE

Vector Reciprocal Estimate.

Syntax

VRECPE{*cond*}.datatype *Qd*, *Qm*

VRECPE{*cond*}.datatype *Dd*, *Dm*

where:

cond

is an optional condition code.

datatype

must be either U32 or F32.

Qd, *Qm*

are the destination vector and the operand vector, for a quadword operation.

Dd, *Dm*

are the destination vector and the operand vector, for a doubleword operation.

Operation

VRECPE finds an approximate reciprocal of each element in a vector, and places the results in a second vector.

Results for out-of-range inputs

The following table shows the results where input values are out of range:

Table 12-13 Results for out-of-range inputs in VRECPE

	Operand element	Result element
Integer	$\leq 0x7FFFFFFF$	$0xFFFFFFFF$
Floating-point	NaN	Default NaN
	Negative 0, Negative Denormal	Negative Infinity ^{aq}
	Positive 0, Positive Denormal	Positive Infinity ^{aq}
	Positive infinity	Positive 0
	Negative infinity	Negative 0

Related concepts

[8.9 NEON data types on page 8-177.](#)

Related references

[11.8 Condition code suffixes on page 11-319.](#)

^{aq} The Division by Zero exception bit in the FPSCR (FPSCR[1]) is set

12.99 VRECPS

Vector Reciprocal Step.

Syntax

VRECPS{*cond*}.F32 {*Qd*}, *Qn*, *Qm*

VRECPS{*cond*}.F32 {*Dd*}, *Dn*, *Dm*

where:

cond

is an optional condition code.

Qd, *Qn*, *Qm*

are the destination vector, the first operand vector, and the second operand vector, for a quadword operation.

Dd, *Dn*, *Dm*

are the destination vector, the first operand vector, and the second operand vector, for a doubleword operation.

Operation

VRECPS multiplies the elements of one vector by the corresponding elements of another vector, subtracts each of the results from 2, and places the final results into the elements of the destination vector.

The Newton-Raphson iteration:

$$x_{n+1} = x_n (2 - dx_n)$$

converges to $(1/d)$ if x_0 is the result of VRECPE applied to d .

Results for out-of-range inputs

The following table shows the results where input values are out of range:

Table 12-14 Results for out-of-range inputs in VRECPS

1st operand element	2nd operand element	Result element
NaN	-	Default NaN
-	NaN	Default NaN
+/- 0.0 or denormal	+/- infinity	2.0
+/- infinity	+/- 0.0 or denormal	2.0

Related references

[11.8 Condition code suffixes on page 11-319.](#)

12.100 VREV16, VREV32, and VREV64

Vector Reverse within halfwords, words, or doublewords.

Syntax

$VREVn\{cond\}.size\ Qd, Qm$

$VREVn\{cond\}.size\ Dd, Dm$

where:

n

must be one of 16, 32, or 64.

$cond$

is an optional condition code.

$size$

must be one of 8, 16, or 32, and must be less than n .

Qd, Qm

specifies the destination vector and the operand vector, for a quadword operation.

Dd, Dm

specifies the destination vector and the operand vector, for a doubleword operation.

Operation

VREV16 reverses the order of 8-bit elements within each halfword of the vector, and places the result in the corresponding destination vector.

VREV32 reverses the order of 8-bit or 16-bit elements within each word of the vector, and places the result in the corresponding destination vector.

VREV64 reverses the order of 8-bit, 16-bit, or 32-bit elements within each doubleword of the vector, and places the result in the corresponding destination vector.

Related references

[11.8 Condition code suffixes on page 11-319.](#)

12.101 VRHADD

Vector Rounding Halving Add.

Syntax

`VRHADD{cond}.datatype {Qd}, Qn, Qm`

`VRHADD{cond}.datatype {Dd}, Dn, Dm`

where:

cond

is an optional condition code.

datatype

must be one of S8, S16, S32, U8, U16, or U32.

Qd, Qn, Qm

are the destination vector, the first operand vector, and the second operand vector, for a quadword operation.

Dd, Dn, Dm

are the destination vector, the first operand vector, and the second operand vector, for a doubleword operation.

Operation

VRHADD adds corresponding elements in two vectors, shifts each result right one bit, and places the results in the destination vector. Results are rounded.

Related concepts

[8.9 NEON data types on page 8-177.](#)

Related references

[11.8 Condition code suffixes on page 11-319.](#)

12.102 VRSHL (by signed variable)

Vector Rounding Shift Left by signed variable.

Syntax

`VRSHL{cond}.datatype {Qd}, Qm, Qn`

`VRSHL{cond}.datatype {Dd}, Dm, Dn`

where:

cond

is an optional condition code.

datatype

must be one of S8, S16, S32, S64, U8, U16, U32, or U64.

Qd, Qm, Qn

are the destination vector, the first operand vector, and the second operand vector, for a quadword operation.

Dd, Dm, Dn

are the destination vector, the first operand vector, and the second operand vector, for a doubleword operation.

Operation

VRSHL takes each element in a vector, shifts them by a value from the least significant byte of the corresponding element of a second vector, and places the results in the destination vector. If the shift value is positive, the operation is a left shift. Otherwise, it is a rounding right shift.

Related concepts

[8.9 NEON data types on page 8-177.](#)

Related references

[11.8 Condition code suffixes on page 11-319.](#)

12.103 VRSHR (by immediate)

Vector Rounding Shift Right by immediate value.

Syntax

`VRSHR{cond}.datatype {Qd}, Qm, #imm`

`VRSHR{cond}.datatype {Dd}, Dm, #imm`

where:

cond

is an optional condition code.

datatype

must be one of S8, S16, S32, S64, U8, U16, U32, or U64.

Qd, Qm

are the destination vector and the operand vector, for a quadword operation.

Dd, Dm

are the destination vector and the operand vector, for a doubleword operation.

imm

is the immediate value specifying the size of the shift, in the range 0 to (size(*datatype*)). The ranges are shown in the following table:

Table 12-15 Available immediate ranges in VRSHR (by immediate)

datatype	imm range
S8 or U8	0 to 8
S16 or U16	0 to 16
S32 or U32	0 to 32
S64 or U64	0 to 64

VRSHR with an immediate value of zero is a pseudo-instruction for VORR.

Operation

VRSHR takes each element in a vector, right shifts them by an immediate value, and places the results in the destination vector. The results are rounded.

Related concepts

[8.9 NEON data types](#) on page 8-177.

Related references

[12.58 VMOV \(register\)](#) on page 12-637.

[11.8 Condition code suffixes](#) on page 11-319.

12.104 VRSHRN (by immediate)

Vector Rounding Shift Right, Narrow, by immediate value.

Syntax

`VRSHRN{cond}.datatype Dd, Qm, #imm`

where:

cond

is an optional condition code.

datatype

must be one of I16, I32, or I64.

Dd, Qm

are the destination vector and the operand vector.

imm

is the immediate value specifying the size of the shift, in the range 0 to $(\text{size}(\text{datatype})/2)$. The ranges are shown in the following table:

Table 12-16 Available immediate ranges in VRSHRN (by immediate)

datatype	imm range
I16	0 to 8
I32	0 to 16
I64	0 to 32

VRSHRN with an immediate value of zero is a pseudo-instruction for VMOVN.

Operation

VRSHRN takes each element in a quadword vector, right shifts them by an immediate value, and places the results in a doubleword vector. The results are rounded.

Related concepts

[8.9 NEON data types on page 8-177.](#)

Related references

[12.62 VMOVN on page 12-641.](#)

[11.8 Condition code suffixes on page 11-319.](#)

12.105 VRSQRTE

Vector Reciprocal Square Root Estimate.

Syntax

VRSQRTE{*cond*}.*datatype* *Qd*, *Qm*

VRSQRTE{*cond*}.*datatype* *Dd*, *Dm*

where:

cond

is an optional condition code.

datatype

must be either U32 or F32.

Qd, *Qm*

are the destination vector and the operand vector, for a quadword operation.

Dd, *Dm*

are the destination vector and the operand vector, for a doubleword operation.

Operation

VRSQRTE finds an approximate reciprocal square root of each element in a vector, and places the results in a second vector.

Results for out-of-range inputs

The following table shows the results where input values are out of range:

Table 12-17 Results for out-of-range inputs in VRSQRTE

	Operand element	Result element
Integer	<= 0x3FFFFFFF	0xFFFFFFFF
Floating-point	NaN, Negative Normal, Negative Infinity	Default NaN
	Negative 0, Negative Denormal	Negative Infinity ^{ar}
	Positive 0, Positive Denormal	Positive Infinity ^{ar}
	Positive infinity	Positive 0
		Negative 0

Related concepts

[8.9 NEON data types on page 8-177.](#)

Related references

[11.8 Condition code suffixes on page 11-319.](#)

^{ar} The Division by Zero exception bit in the FPSCR (FPSCR[1]) is set

12.106 VRSQRTS

Vector Reciprocal Square Root Step.

Syntax

VRSQRTS{*cond*}.F32 {*Qd*}, *Qn*, *Qm*

VRSQRTS{*cond*}.F32 {*Dd*}, *Dn*, *Dm*

where:

cond

is an optional condition code.

Qd, *Qn*, *Qm*

are the destination vector, the first operand vector, and the second operand vector, for a quadword operation.

Dd, *Dn*, *Dm*

are the destination vector, the first operand vector, and the second operand vector, for a doubleword operation.

Operation

VRSQRTS multiplies the elements of one vector by the corresponding elements of another vector, subtracts each of the results from three, divides these results by two, and places the final results into the elements of the destination vector.

The Newton-Raphson iteration:

$$x_{n+1} = x_n (3 - dx_n^2) / 2$$

converges to $(1/\sqrt{d})$ if x_0 is the result of VRSQRTE applied to d .

Results for out-of-range inputs

The following table shows the results where input values are out of range:

Table 12-18 Results for out-of-range inputs in VRSQRTS

1st operand element	2nd operand element	Result element
NaN	-	Default NaN
-	NaN	Default NaN
+/- 0.0 or denormal	+/- infinity	1.5
+/- infinity	+/- 0.0 or denormal	1.5

Related references

[11.8 Condition code suffixes on page 11-319.](#)

12.107 VRSRA (by immediate)

Vector Rounding Shift Right by immediate value and Accumulate.

Syntax

`VRSRA{cond}.datatype {Qd}, Qm, #imm`

`VRSRA{cond}.datatype {Dd}, Dm, #imm`

where:

cond

is an optional condition code.

datatype

must be one of S8, S16, S32, S64, U8, U16, U32, or U64.

Qd, Qm

are the destination vector and the operand vector, for a quadword operation.

Dd, Dm

are the destination vector and the operand vector, for a doubleword operation.

imm

is the immediate value specifying the size of the shift, in the range 1 to (size(*datatype*)). The ranges are shown in the following table:

Table 12-19 Available immediate ranges in VRSRA (by immediate)

datatype	imm range
S8 or U8	1 to 8
S16 or U16	1 to 16
S32 or U32	1 to 32
S64 or U64	1 to 64

Operation

VRSRA takes each element in a vector, right shifts them by an immediate value, and accumulates the results into the destination vector. The results are rounded.

Related concepts

[8.9 NEON data types on page 8-177.](#)

Related references

[11.8 Condition code suffixes on page 11-319.](#)

12.108 VRSUBHN

Vector Rounding Subtract and Narrow, selecting High half.

Syntax

VRSUBHN{*cond*}.*datatype* *Dd*, *Qn*, *Qm*

where:

cond

is an optional condition code.

datatype

must be one of I16, I32, or I64.

Dd, *Qn*, *Qm*

are the destination vector, the first operand vector, and the second operand vector.

Operation

VRSUBHN subtracts the elements of one quadword vector from the corresponding elements of another quadword vector, selects the most significant halves of the results, and places the final results in the destination doubleword vector. Results are rounded.

Related concepts

[8.9 NEON data types on page 8-177.](#)

Related references

[11.8 Condition code suffixes on page 11-319.](#)

12.109 VSHL (by immediate)

Vector Shift Left by immediate.

Syntax

VSHL{*cond*}.datatype {*Qd*}, *Qm*, #*imm*

VSHL{*cond*}.datatype {*Dd*}, *Dm*, #*imm*

where:

cond

is an optional condition code.

datatype

must be one of I8, I16, I32, or I64.

Qd, *Qm*

are the destination and operand vectors, for a quadword operation.

Dd, *Dm*

are the destination and operand vectors, for a doubleword operation.

imm

is the immediate value specifying the size of the shift. The ranges are shown in the following table:

Table 12-20 Available immediate ranges in VSHL (by immediate)

datatype	imm range
I8	0 to 7
I16	0 to 15
I32	0 to 31
I64	0 to 63

Operation

VSHL takes each element in a vector of integers, left shifts them by an immediate value, and places the results in the destination vector.

Bits shifted out of the left of each element are lost.

The following figure shows the operation of VSHL with two elements and a shift value of one. The least significant bit in each element in the destination vector is set to zero.

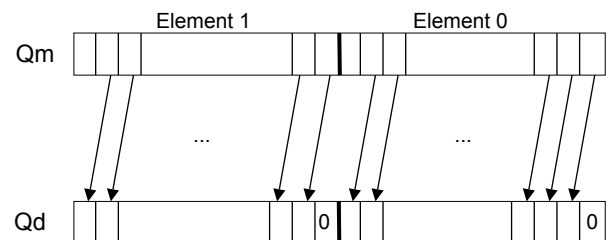

Figure 12-6 Operation of quadword VSHL.I64 *Qd*, *Qm*, #1

Related concepts

[8.9 NEON data types on page 8-177.](#)

Related references

[11.8 Condition code suffixes on page 11-319.](#)

12.110 VSHL (by signed variable)

Vector Shift Left by signed variable.

Syntax

VSHL{*cond*}.*datatype* {*Qd*}, *Qm*, *Qn*

VSHL{*cond*}.*datatype* {*Dd*}, *Dm*, *Dn*

where:

cond

is an optional condition code.

datatype

must be one of S8, S16, S32, S64, U8, U16, U32, or U64.

Qd, *Qm*, *Qn*

are the destination vector, the first operand vector, and the second operand vector, for a quadword operation.

Dd, *Dm*, *Dn*

are the destination vector, the first operand vector, and the second operand vector, for a doubleword operation.

Operation

VSHL takes each element in a vector, shifts them by the value from the least significant byte of the corresponding element of a second vector, and places the results in the destination vector. If the shift value is positive, the operation is a left shift. Otherwise, it is a truncating right shift.

Related concepts

[8.9 NEON data types on page 8-177.](#)

Related references

[11.8 Condition code suffixes on page 11-319.](#)

12.111 VSHLL (by immediate)

Vector Shift Left Long.

Syntax

VSHLL{*cond*}.*datatype* *Qd*, *Dm*, #*imm*

where:

cond

is an optional condition code.

datatype

must be one of S8, S16, S32, U8, U16, or U32.

Qd, *Dm*

are the destination and operand vectors, for a long operation.

imm

is the immediate value specifying the size of the shift. The ranges are shown in the following table:

Table 12-21 Available immediate ranges in VSHLL (by immediate)

datatype	imm range
S8 or U8	1 to 8
S16 or U16	1 to 16
S32 or U32	1 to 32

0 is permitted, but the resulting code disassembles to VMOVL.

Operation

VSHLL takes each element in a vector of integers, left shifts them by an immediate value, and places the results in the destination vector. Values are sign or zero extended.

Related concepts

[8.9 NEON data types on page 8-177.](#)

Related references

[11.8 Condition code suffixes on page 11-319.](#)

12.112 VSHR (by immediate)

Vector Shift Right by immediate value.

Syntax

VSHR{*cond*}.*datatype* {*Qd*}, *Qm*, #*imm*

VSHR{*cond*}.*datatype* {*Dd*}, *Dm*, #*imm*

where:

cond

is an optional condition code.

datatype

must be one of S8, S16, S32, S64, U8, U16, U32, or U64.

Qd, *Qm*

are the destination vector and the operand vector, for a quadword operation.

Dd, *Dm*

are the destination vector and the operand vector, for a doubleword operation.

imm

is the immediate value specifying the size of the shift. The ranges are shown in the following table:

Table 12-22 Available immediate ranges in VSHR (by immediate)

datatype	imm range
S8 or U8	0 to 8
S16 or U16	0 to 16
S32 or U32	0 to 32
S64 or U64	0 to 64

VSHR with an immediate value of zero is a pseudo-instruction for VORR.

Operation

VSHR takes each element in a vector, right shifts them by an immediate value, and places the results in the destination vector. The results are truncated.

Related concepts

[8.9 NEON data types](#) on page 8-177.

Related references

[12.58 VMOV \(register\)](#) on page 12-637.

[11.8 Condition code suffixes](#) on page 11-319.

12.113 VSHRN (by immediate)

Vector Shift Right, Narrow, by immediate value.

Syntax

VSHRN{*cond*}.*datatype* *Dd*, *Qm*, #*imm*

where:

cond

is an optional condition code.

datatype

must be one of I16, I32, or I64.

Dd, *Qm*

are the destination vector and the operand vector.

imm

is the immediate value specifying the size of the shift. The ranges are shown in the following table:

Table 12-23 Available immediate ranges in VSHRN (by immediate)

datatype	imm range
I16	0 to 8
I32	0 to 16
I64	0 to 32

VSHRN with an immediate value of zero is a pseudo-instruction for VMOVN.

Operation

VSHRN takes each element in a quadword vector, right shifts them by an immediate value, and places the results in a doubleword vector. The results are truncated.

Related concepts

[8.9 NEON data types on page 8-177.](#)

Related references

[12.62 VMOVN on page 12-641.](#)

[11.8 Condition code suffixes on page 11-319.](#)

12.114 VSLI

Vector Shift Left and Insert.

Syntax

`VSLI{cond}.size {Qd}, Qm, #imm`

`VSLI{cond}.size {Dd}, Dm, #imm`

where:

cond

is an optional condition code.

size

must be one of 8, 16, 32, or 64.

Qd, *Qm*

are the destination vector and the operand vector, for a quadword operation.

Dd, *Dm*

are the destination vector and the operand vector, for a doubleword operation.

imm

is the immediate value specifying the size of the shift, in the range 0 to (*size* – 1).

Operation

VSLI takes each element in a vector, left shifts them by an immediate value, and inserts the results in the destination vector. Bits shifted out of the left of each element are lost. The following figure shows the operation of VSLI with two elements and a shift value of one. The least significant bit in each element in the destination vector is unchanged.

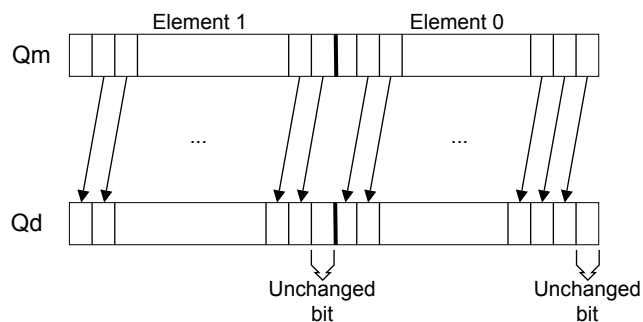

Figure 12-7 Operation of quadword VSLI.64 Qd, Qm, #1

Related references

[11.8 Condition code suffixes](#) on page 11-319.

12.115 VSRA (by immediate)

Vector Shift Right by immediate value and Accumulate.

Syntax

`VSRA{cond}.datatype {Qd}, Qm, #imm`

`VSRA{cond}.datatype {Dd}, Dm, #imm`

where:

cond

is an optional condition code.

datatype

must be one of S8, S16, S32, S64, U8, U16, U32, or U64.

Qd, Qm

are the destination vector and the operand vector, for a quadword operation.

Dd, Dm

are the destination vector and the operand vector, for a doubleword operation.

imm

is the immediate value specifying the size of the shift. The ranges are shown in the following table:

Table 12-24 Available immediate ranges in VSRA (by immediate)

datatype	imm range
S8 or U8	1 to 8
S16 or U16	1 to 16
S32 or U32	1 to 32
S64 or U64	1 to 64

Operation

VSRA takes each element in a vector, right shifts them by an immediate value, and accumulates the results into the destination vector. The results are truncated.

Related concepts

[8.9 NEON data types on page 8-177.](#)

Related references

[11.8 Condition code suffixes on page 11-319.](#)

12.116 VSRI

Vector Shift Right and Insert.

Syntax

`VSRI{cond}.size {Qd}, Qm, #imm`

`VSRI{cond}.size {Dd}, Dm, #imm`

where:

cond

is an optional condition code.

size

must be one of 8, 16, 32, or 64.

Qd, Qm

are the destination vector and the operand vector, for a quadword operation.

Dd, Dm

are the destination vector and the operand vector, for a doubleword operation.

imm

is the immediate value specifying the size of the shift, in the range 1 to *size*.

Operation

VSRI takes each element in a vector, right shifts them by an immediate value, and inserts the results in the destination vector. Bits shifted out of the right of each element are lost. The following figure shows the operation of VSRI with a single element and a shift value of two. The two most significant bits in the destination vector are unchanged.

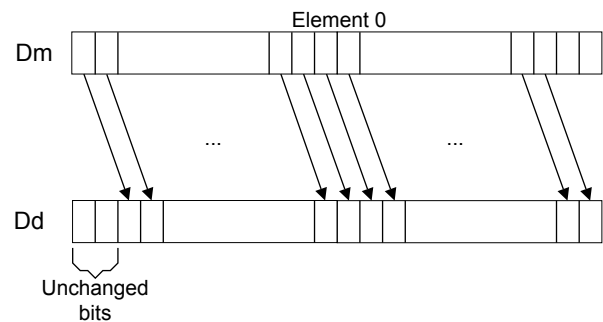

Figure 12-8 Operation of doubleword VSRI.64 Dd, Dm, #2

Related references

[11.8 Condition code suffixes](#) on page 11-319.

12.117 VSTM

Extension register store multiple.

Syntax

VSTM $mode\{cond\}$ $Rn\{!\}$, *Registers*

where:

mode

must be one of:

IA

meaning Increment address After each transfer. IA is the default, and can be omitted.

DB

meaning Decrement address Before each transfer.

EA

meaning Empty Ascending stack operation. This is the same as IA for stores.

FD

meaning Full Descending stack operation. This is the same as DB for stores.

cond

is an optional condition code.

Rn

is the ARM register holding the base address for the transfer.

!

is optional. ! specifies that the updated base address must be written back to *Rn*. If ! is not specified, *mode* must be IA.

Registers

is a list of consecutive extension registers enclosed in braces, { and }. The list can be comma-separated, or in range format. There must be at least one register in the list.

You can specify D or Q registers, but they must not be mixed. The number of registers must not exceed 16 D registers, or 8 Q registers. If Q registers are specified, on disassembly they are shown as D registers.

Note

V PUSH *Registers* is equivalent to VSTMDB *sp!*, *Registers*.

You can use either form of this instruction. They both disassemble to V PUSH.

Related concepts

[4.15 Stack implementation using LDM and STM on page 4-82.](#)

Related references

[11.8 Condition code suffixes on page 11-319.](#)

[13.31 VSTM \(floating-point\) on page 13-745.](#)

12.118 VSTn (multiple n-element structures)

Vector Store multiple *n*-element structures.

Syntax

`VSTn{cond}.datatype List, [Rn{@align}]!}`

`VSTn{cond}.datatype List, [Rn{@align}], Rm`

where:

n

must be one of 1, 2, 3, or 4.

cond

is an optional condition code.

datatype

see the following table for options.

List

is the list of NEON registers enclosed in braces, { and }. See the following table for options.

Rn

is the ARM register containing the base address. *Rn* cannot be PC.

align

specifies an optional alignment. See the following table for options.

!

if ! is present, *Rn* is updated to (*Rn* + the number of bytes transferred by the instruction). The update occurs after all the stores have taken place.

Rm

is an ARM register containing an offset from the base address. If *Rm* is present, the instruction updates *Rn* to (*Rn* + *Rm*) after using the address to access memory. *Rm* cannot be SP or PC.

Operation

VSTn stores multiple *n*-element structures to memory from one or more NEON registers, with interleaving (unless *n* == 1). Every element of each register is stored.

Table 12-25 Permitted combinations of parameters for VSTn (multiple n-element structures)

<i>n</i>	<i>datatype</i>	<i>list</i> ^{as}	<i>align</i> ^{at}	<i>alignment</i>
1	8, 16, 32, or 64	{Dd}	@64	8-byte
		{Dd, D(d+1)}	@64 or @128	8-byte or 16-byte
		{Dd, D(d+1), D(d+2)}	@64	8-byte
		{Dd, D(d+1), D(d+2), D(d+3)}	@64, @128, or @256	8-byte, 16-byte, or 32-byte
2	8, 16, or 32	{Dd, D(d+1)}	@64, @128	8-byte or 16-byte
		{Dd, D(d+2)}	@64, @128	8-byte or 16-byte
		{Dd, D(d+1), D(d+2), D(d+3)}	@64, @128, or @256	8-byte, 16-byte, or 32-byte
3	8, 16, or 32	{Dd, D(d+1), D(d+2)}	@64	8-byte
		{Dd, D(d+2), D(d+4)}	@64	8-byte
4	8, 16, or 32	{Dd, D(d+1), D(d+2), D(d+3)}	@64, @128, or @256	8-byte, 16-byte, or 32-byte
		{Dd, D(d+2), D(d+4), D(d+6)}	@64, @128, or @256	8-byte, 16-byte, or 32-byte

^{as} Every register in the list must be in the range D0-D31.

^{at} *align* can be omitted. In this case, standard alignment rules apply.

Related concepts

12.3 Interleaving provided by load and store element and structure instructions on page 12-579.

12.4 Alignment restrictions in load and store element and structure instructions on page 12-580.

Related references

12.40 VLDn (single n-element structure to one lane) on page 12-616.

12.41 VLDn (single n-element structure to all lanes) on page 12-618.

11.8 Condition code suffixes on page 11-319.

12.119 VSTn (single n-element structure to one lane)

Vector Store single *n*-element structure to one lane.

Syntax

`VSTn{cond}.datatype List, [Rn{@align}]{!}`

`VSTn{cond}.datatype List, [Rn{@align}], Rm`

where:

n

must be one of 1, 2, 3, or 4.

cond

is an optional condition code.

datatype

see the following table.

List

is the list of NEON registers enclosed in braces, { and }. See the following table for options.

Rn

is the ARM register containing the base address. *Rn* cannot be PC.

align

specifies an optional alignment. See the following table for options.

!

if ! is present, *Rn* is updated to (*Rn* + the number of bytes transferred by the instruction). The update occurs after all the stores have taken place.

Rm

is an ARM register containing an offset from the base address. If *Rm* is present, the instruction updates *Rn* to (*Rn* + *Rm*) after using the address to access memory. *Rm* cannot be SP or PC.

Operation

VSTn stores one *n*-element structure into memory from one or more NEON registers.

Table 12-26 Permitted combinations of parameters for VSTn (single n-element structure to one lane)

<i>n</i>	<i>datatype</i>	<i>list</i> ^{au}	<i>align</i> ^{av}	alignment
1	8	{Dd[x]}	-	Standard only
	16	{Dd[x]}	@16	2-byte
	32	{Dd[x]}	@32	4-byte
2	8	{Dd[x], D(d+1)[x]}	@16	2-byte
	16	{Dd[x], D(d+1)[x]}	@32	4-byte
		{Dd[x], D(d+2)[x]}	@32	4-byte
	32	{Dd[x], D(d+1)[x]}	@64	8-byte
		{Dd[x], D(d+2)[x]}	@64	8-byte
3	8	{Dd[x], D(d+1)[x], D(d+2)[x]}	-	Standard only
	16 or 32	{Dd[x], D(d+1)[x], D(d+2)[x]}	-	Standard only
		{Dd[x], D(d+2)[x], D(d+4)[x]}	-	Standard only

^{au} Every register in the list must be in the range D0-D31.

^{av} *align* can be omitted. In this case, standard alignment rules apply.

Table 12-26 Permitted combinations of parameters for VSTn (single n-element structure to one lane) (continued)

<i>n</i>	<i>datatype</i>	<i>list</i> ^{au}	<i>align</i> ^{av}	alignment
4	8	{Dd[x], D(d+1)[x], D(d+2)[x], D(d+3)[x]}	@32	4-byte
	16	{Dd[x], D(d+1)[x], D(d+2)[x], D(d+3)[x]}	@64	8-byte
		{Dd[x], D(d+2)[x], D(d+4)[x], D(d+6)[x]}	@64	8-byte
	32	{Dd[x], D(d+1)[x], D(d+2)[x], D(d+3)[x]}	@64 or @128	8-byte or 16-byte
		{Dd[x], D(d+2)[x], D(d+4)[x], D(d+6)[x]}	@64 or @128	8-byte or 16-byte

Related concepts

12.3 Interleaving provided by load and store element and structure instructions on page 12-579.

12.4 Alignment restrictions in load and store element and structure instructions on page 12-580.

Related references

12.41 VLDn (single n-element structure to all lanes) on page 12-618.

12.42 VLDn (multiple n-element structures) on page 12-620.

11.8 Condition code suffixes on page 11-319.

12.120 VSTR

Extension register store.

Syntax

VSTR{*cond*}{.64} *Dd*, [*Rn*{, #*offset*}]

where:

cond

is an optional condition code.

Dd

is the extension register to be saved.

Rn

is the ARM register holding the base address for the transfer.

offset

is an optional numeric expression. It must evaluate to a numeric value at assembly time. The value must be a multiple of 4, and lie in the range –1020 to +1020. The value is added to the base address to form the address used for the transfer.

Operation

The VSTR instruction saves the contents of an extension register to memory.

Two words are transferred.

Related concepts

[7.5 Register-relative and PC-relative expressions](#) on page 7-142.

Related references

[12.46 VLDR pseudo-instruction](#) on page 12-625.

[11.8 Condition code suffixes](#) on page 11-319.

[13.32 VSTR \(floating-point\)](#) on page 13-746.

12.121 VSTR (post-increment and pre-decrement)

Pseudo-instruction that stores extension registers with post-increment and pre-decrement forms.

————— **Note** —————

There are also VLDR and VSTR instructions without post-increment and pre-decrement.

Syntax

VSTR{*cond*}{.64} *Dd*, [*Rn*], #*offset* ; post-increment

VSTR{*cond*}{.64} *Dd*, [*Rn*, #-*offset*]! ; pre-decrement

where:

cond

is an optional condition code.

Dd

is the extension register to be saved.

Rn

is the ARM register holding the base address for the transfer.

offset

is a numeric expression that must evaluate to 8 at assembly time.

Operation

The post-increment instruction increments the base address in the register by the offset value, after the transfer. The pre-decrement instruction decrements the base address in the register by the offset value, and then performs the transfer using the new address in the register. This pseudo-instruction assembles to a VSTM instruction.

Related references

[12.120 VSTR](#) on page 12-701.

[12.117 VSTM](#) on page 12-696.

[11.8 Condition code suffixes](#) on page 11-319.

[13.33 VSTR \(post-increment and pre-decrement, floating-point\)](#) on page 13-747.

12.122 VSUB

Vector Subtract.

Syntax

`VSUB{cond}.datatype {Qd}, Qn, Qm`

`VSUB{cond}.datatype {Dd}, Dn, Dm`

where:

cond

is an optional condition code.

datatype

must be one of I8, I16, I32, I64, or F32.

Qd, Qn, Qm

are the destination vector, the first operand vector, and the second operand vector, for a quadword operation.

Operation

VSUB subtracts the elements of one vector from the corresponding elements of another vector, and places the results in the destination vector.

Related concepts

[8.9 NEON data types on page 8-177.](#)

Related references

[11.8 Condition code suffixes on page 11-319.](#)

12.123 VSUBHN

Vector Subtract and Narrow, selecting High half.

Syntax

`VSUBHN{cond}.datatype Dd, Qn, Qm`

where:

cond

is an optional condition code.

datatype

must be one of I16, I32, or I64.

Dd, *Qn*, *Qm*

are the destination vector, the first operand vector, and the second operand vector.

Operation

VSUBHN subtracts the elements of one quadword vector from the corresponding elements of another quadword vector, selects the most significant halves of the results, and places the final results in the destination doubleword vector. Results are truncated.

Related concepts

[8.9 NEON data types on page 8-177.](#)

Related references

[11.8 Condition code suffixes on page 11-319.](#)

12.124 VSUBL and VSUBW

Vector Subtract Long, Vector Subtract Wide.

Syntax

`VSUBL{cond}.datatype Qd, Dn, Dm ; Long operation`

`VSUBW{cond}.datatype {Qd}, Qn, Dm ; Wide operation`

where:

cond

is an optional condition code.

datatype

must be one of S8, S16, S32, U8, U16, or U32.

Qd, Dn, Dm

are the destination vector, the first operand vector, and the second operand vector, for a long operation.

Qd, Qn, Dm

are the destination vector, the first operand vector, and the second operand vector, for a wide operation.

Operation

VSUBL subtracts the elements of one doubleword vector from the corresponding elements of another doubleword vector, and places the results in the destination quadword vector.

VSUBW subtracts the elements of a doubleword vector from the corresponding elements of a quadword vector, and places the results in the destination quadword vector.

Related concepts

[8.9 NEON data types on page 8-177.](#)

Related references

[11.8 Condition code suffixes on page 11-319.](#)

12.125 VSWP

Vector Swap.

Syntax

VSWP{*cond*}{*.datatype*} *Qd*, *Qm*

VSWP{*cond*}{*.datatype*} *Dd*, *Dm*

where:

cond

is an optional condition code.

datatype

is an optional datatype. The assembler ignores *datatype*.

Qd, *Qm*

specifies the vectors for a quadword operation.

Dd, *Dm*

specifies the vectors for a doubleword operation.

Operation

VSWP exchanges the contents of two vectors. The vectors can be either doubleword or quadword. There is no distinction between data types.

Related references

[11.8 Condition code suffixes on page 11-319.](#)

12.126 VTBL and VTBX

Vector Table Lookup, Vector Table Extension.

Syntax

$Vop\{cond\}.8 Dd, List, Dm$

where:

op

must be either TBL or TBX.

cond

is an optional condition code.

Dd

specifies the destination vector.

List

Specifies the vectors containing the table. It must be one of:

- $\{Dn\}$.
- $\{Dn, D(n+1)\}$.
- $\{Dn, D(n+1), D(n+2)\}$.
- $\{Dn, D(n+1), D(n+2), D(n+3)\}$.
- $\{Qn, Q(n+1)\}$.

All the registers in *List* must be in the range D0-D31 or Q0-Q15 and must not wrap around the end of the register bank. For example $\{D31, D0, D1\}$ is not permitted. If *List* contains Q registers, they disassemble to the equivalent D registers.

Dm

specifies the index vector.

Operation

VTBL uses byte indexes in a control vector to look up byte values in a table and generate a new vector. Indexes out of range return zero.

VTBX works in the same way, except that indexes out of range leave the destination element unchanged.

Related references

[11.8 Condition code suffixes on page 11-319.](#)

12.127 VTRN

Vector Transpose.

Syntax

`VTRN{cond}.size Qd, Qm`

`VTRN{cond}.size Dd, Dm`

where:

cond is an optional condition code.

size must be one of 8, 16, or 32.

Qd, Qm specifies the vectors, for a quadword operation.

Dd, Dm specifies the vectors, for a doubleword operation.

Operation

VTRN treats the elements of its operand vectors as elements of 2 x 2 matrices, and transposes the matrices. The following figures show examples of the operation of VTRN:

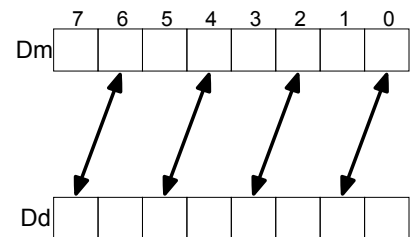

Figure 12-9 Operation of doubleword VTRN.8

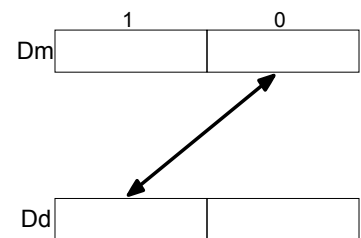

Figure 12-10 Operation of doubleword VTRN.32

Related references

[11.8 Condition code suffixes on page 11-319.](#)

12.128 VTST

Vector Test bits.

Syntax

`VTST{cond}.size {Qd}, Qn, Qm`

`VTST{cond}.size {Dd}, Dn, Dm`

where:

cond

is an optional condition code.

size

must be one of 8, 16, or 32.

Qd, *Qn*, *Qm*

specifies the destination register, the first operand register, and the second operand register, for a quadword operation.

Dd, *Dn*, *Dm*

specifies the destination register, the first operand register, and the second operand register, for a doubleword operation.

Operation

VTST takes each element in a vector, and bitwise logical ANDs them with the corresponding element of a second vector. If the result is not zero, the corresponding element in the destination vector is set to all ones. Otherwise, it is set to all zeros.

Related references

[11.8 Condition code suffixes on page 11-319.](#)

12.129 VUZP

Vector Unzip.

Syntax

`VUZP{cond}.size Qd, Qm`

`VUZP{cond}.size Dd, Dm`

where:

`cond`

is an optional condition code.

`size`

must be one of 8, 16, or 32.

`Qd, Qm`

specifies the vectors, for a quadword operation.

`Dd, Dm`

specifies the vectors, for a doubleword operation.

Note

The following are all the same instruction:

- `VZIP.32 Dd, Dm`.
- `VUZP.32 Dd, Dm`.
- `VTRN.32 Dd, Dm`.

The instruction is disassembled as `VTRN.32 Dd, Dm`.

Operation

VUZP de-interleaves the elements of two vectors.

De-interleaving is the inverse process of interleaving.

Table 12-27 Operation of doubleword VUZP.8

	Register state before operation								Register state after operation							
Dd	A ₇	A ₆	A ₅	A ₄	A ₃	A ₂	A ₁	A ₀	B ₆	B ₄	B ₂	B ₀	A ₆	A ₄	A ₂	A ₀
Dm	B ₇	B ₆	B ₅	B ₄	B ₃	B ₂	B ₁	B ₀	B ₇	B ₅	B ₃	B ₁	A ₇	A ₅	A ₃	A ₁

Table 12-28 Operation of quadword VUZP.32

	Register state before operation				Register state after operation			
Qd	A ₃	A ₂	A ₁	A ₀	B ₂	B ₀	A ₂	A ₀
Qm	B ₃	B ₂	B ₁	B ₀	B ₃	B ₁	A ₃	A ₁

Related concepts

[12.3 Interleaving provided by load and store element and structure instructions](#) on page 12-579.

Related references

[12.127 VTRN](#) on page 12-708.

[11.8 Condition code suffixes](#) on page 11-319.

12.130 VZIP

Vector Zip.

Syntax

VZIP{*cond*}.size *Qd*, *Qm*

VZIP{*cond*}.size *Dd*, *Dm*

where:

cond

is an optional condition code.

size

must be one of 8, 16, or 32.

Qd, *Qm*

specifies the vectors, for a quadword operation.

Dd, *Dm*

specifies the vectors, for a doubleword operation.

Note

The following are all the same instruction:

- VZIP.32 *Dd*, *Dm*.
- VUZP.32 *Dd*, *Dm*.
- VTRN.32 *Dd*, *Dm*.

The instruction is disassembled as VTRN.32 *Dd*, *Dm*.

Operation

VZIP interleaves the elements of two vectors.

Table 12-29 Operation of doubleword VZIP.8

	Register state before operation								Register state after operation							
Dd	A ₇	A ₆	A ₅	A ₄	A ₃	A ₂	A ₁	A ₀	B ₃	A ₃	B ₂	A ₂	B ₁	A ₁	B ₀	A ₀
Dm	B ₇	B ₆	B ₅	B ₄	B ₃	B ₂	B ₁	B ₀	B ₇	A ₇	B ₆	A ₆	B ₅	A ₅	B ₄	A ₄

Table 12-30 Operation of quadword VZIP.32

	Register state before operation				Register state after operation			
Qd	A ₃	A ₂	A ₁	A ₀	B ₁	A ₁	B ₀	A ₀
Qm	B ₃	B ₂	B ₁	B ₀	B ₃	A ₃	B ₂	A ₂

Related concepts

[12.3 Interleaving provided by load and store element and structure instructions](#) on page 12-579.

Related references

[12.127 VTRN](#) on page 12-708.

[11.8 Condition code suffixes](#) on page 11-319.

Chapter 13

VFP Instructions

Describes the assembly programming of the VFP hardware.

It contains the following sections:

- *13.1 Summary of VFP instructions* on page 13-714.
- *13.2 VABS (floating-point)* on page 13-716.
- *13.3 VADD (floating-point)* on page 13-717.
- *13.4 VCMP, VCMPE* on page 13-718.
- *13.5 VCVT (between single-precision and double-precision)* on page 13-719.
- *13.6 VCVT (between floating-point and integer)* on page 13-720.
- *13.7 VCVT (between floating-point and fixed-point)* on page 13-721.
- *13.8 VCVTB, VCVTT (half-precision extension)* on page 13-722.
- *13.9 VDIV* on page 13-723.
- *13.10 VFMA, VFMS, VFNMA, VFNMS (floating-point)* on page 13-724.
- *13.11 VLDM (floating-point)* on page 13-725.
- *13.12 VLDR (floating-point)* on page 13-726.
- *13.13 VLDR (post-increment and pre-decrement, floating-point)* on page 13-727.
- *13.14 VLDR pseudo-instruction* on page 13-728.
- *13.15 VMLA (floating-point)* on page 13-729.
- *13.16 VMLS (floating-point)* on page 13-730.
- *13.17 VMOV (floating-point)* on page 13-731.
- *13.18 VMOV (between one ARM register and single precision VFP)* on page 13-732.
- *13.19 VMOV (between two ARM registers and one or two extension registers)* on page 13-733.
- *13.20 VMOV (between an ARM register and half a double precision VFP register)* on page 13-734.
- *13.21 VMRS* on page 13-735.
- *13.22 VMSR* on page 13-736.
- *13.23 VMUL (floating-point)* on page 13-737.

- *13.24 VNEG (floating-point)* on page 13-738.
- *13.25 VNMLA (floating-point)* on page 13-739.
- *13.26 VNMLS (floating-point)* on page 13-740.
- *13.27 VNMUL (floating-point)* on page 13-741.
- *13.28 VPOP (floating-point)* on page 13-742.
- *13.29 VPUSH (floating-point)* on page 13-743.
- *13.30 VSQRT* on page 13-744.
- *13.31 VSTM (floating-point)* on page 13-745.
- *13.32 VSTR (floating-point)* on page 13-746.
- *13.33 VSTR (post-increment and pre-decrement, floating-point)* on page 13-747.
- *13.34 VSUB (floating-point)* on page 13-748.

13.1 Summary of VFP instructions

This table provides a summary of the VFP instructions and the VFP architectures that support them.

Table 13-1 Summary of VFP instructions

Mnemonic	Brief description	Arch.
VABS	Absolute value	All
VADD	Add	All
VCMP, VCMPE	Compare	All
VCVT	Convert between single-precision and double-precision	All
	Convert between floating-point and integer	All
	Convert between floating-point and fixed-point	VFPv3, VFPv4
VCVTB, VCVTT	Convert between half-precision and single-precision floating-point	Half-precision, VFPv4
VDIV	Divide	All
VFMA, VFMS	Fused multiply accumulate, Fused multiply subtract	VFPv4
VFNMA, VFNMS	Fused multiply accumulate with negation, Fused multiply subtract with negation	VFPv4
VLDM	Load multiple	All
VLDR	Load (see also VLDR pseudo-instruction)	All
	Load (post-increment and pre-decrement)	All
VMLA	Multiply accumulate	All
VMLS	Multiply subtract	All
VMOV	Insert floating-point immediate in single-precision or double-precision register	VFPv3, VFPv4
	Transfer from one single-precision or double-precision register to another	All
	Transfer from single-precision to ARM register	All
	Transfer from ARM register to single-precision	All
	Transfer from two ARM registers to two single-precision or one double-precision register	All
	Transfer from two single-precision registers or one double-precision register to two ARM registers	All
	Transfer from ARM register to half a double-precision register	All
	Transfer from half a double-precision register to ARM register	All
VMRS	Transfer from VFP system register to ARM register	All
VMSR	Transfer from ARM register to VFP system register	All
VMUL	Multiply	All
VNEG	Negate	All
VNMLA	Negated multiply accumulate	All
VNMLS	Negated multiply subtract	All
VNMUL	Negated multiply	All
VPOP	Pop VFP registers from full-descending stack	All

Table 13-1 Summary of VFP instructions (continued)

Mnemonic	Brief description	Arch.
VPU SH	Push VFP registers to full-descending stack	All
VSQRT	Square Root	All
VSTM	Store multiple	All
VSTR	Store	All
	Store (post-increment and pre-decrement)	All
VSUB	Subtract	All

13.2 VABS (floating-point)

Floating-point absolute value.

Syntax

VABS{*cond*}.F32 *Sd*, *Sm*

VABS{*cond*}.F64 *Dd*, *Dm*

where:

cond

is an optional condition code.

Sd, *Sm*

are the single-precision registers for the result and operand.

Dd, *Dm*

are the double-precision registers for the result and operand.

Operation

The VABS instruction takes the contents of *Sm* or *Dm*, clears the sign bit, and places the result in *Sd* or *Dd*. This gives the absolute value.

If the operand is a NaN, the sign bit is cleared, but no exception is produced.

Floating-point exceptions

VABS instructions do not produce any exceptions.

Related references

[11.8 Condition code suffixes](#) on page 11-319.

13.3 VADD (floating-point)

Floating-point add.

Syntax

VADD{*cond*}.F32 {*Sd*}, *Sn*, *Sm*

VADD{*cond*}.F64 {*Dd*}, *Dn*, *Dm*

where:

cond

is an optional condition code.

Sd, *Sn*, *Sm*

are the single-precision registers for the result and operands.

Dd, *Dn*, *Dm*

are the double-precision registers for the result and operands.

Operation

The VADD instruction adds the values in the operand registers and places the result in the destination register.

Floating-point exceptions

The VADD instruction can produce Invalid Operation, Overflow, or Inexact exceptions.

Related references

[11.8 Condition code suffixes](#) on page 11-319.

13.4 VCMP, VCMPE

Floating-point compare.

Syntax

VCMP{E}{*cond*}.F32 *Sd*, *Sm*

VCMP{E}{*cond*}.F32 *Sd*, #0

VCMP{E}{*cond*}.F64 *Dd*, *Dm*

VCMP{E}{*cond*}.F64 *Dd*, #0

where:

E

if present, indicates that the instruction raises an Invalid Operation exception if either operand is a quiet or signaling NaN. Otherwise, it raises the exception only if either operand is a signaling NaN.

cond

is an optional condition code.

Sd, *Sm*

are the single-precision registers holding the operands.

Dd, *Dm*

are the double-precision registers holding the operands.

Operation

The VCMP{E} instruction subtracts the value in the second operand register (or 0 if the second operand is #0) from the value in the first operand register, and sets the VFP condition flags based on the result.

Floating-point exceptions

VCMP{E} instructions can produce Invalid Operation exceptions.

Related references

[11.8 Condition code suffixes](#) on page 11-319.

13.5 VCVT (between single-precision and double-precision)

Convert between single-precision and double-precision numbers.

Syntax

$VCVT\{cond\}.F64.F32 Dd, Sm$

$VCVT\{cond\}.F32.F64 Sd, Dm$

where:

cond

is an optional condition code.

Dd

is a double-precision register for the result.

Sm

is a single-precision register holding the operand.

Sd

is a single-precision register for the result.

Dm

is a double-precision register holding the operand.

Operation

These instructions convert the single-precision value in *Sm* to double-precision, placing the result in *Dd*, or the double-precision value in *Dm* to single-precision, placing the result in *Sd*.

Floating-point exceptions

These instructions can produce Invalid Operation, Input Denormal, Overflow, Underflow, or Inexact exceptions.

Related references

[11.8 Condition code suffixes](#) on page 11-319.

13.6 VCVT (between floating-point and integer)

Convert between floating-point numbers and integers.

Syntax

`VCVT{R}{cond}.type.F64 Sd, Dm`

`VCVT{R}{cond}.type.F32 Sd, Sm`

`VCVT{cond}.F64.type Dd, Sm`

`VCVT{cond}.F32.type Sd, Sm`

where:

R

makes the operation use the rounding mode specified by the FPSCR. Otherwise, the operation rounds towards zero.

cond

is an optional condition code.

type

can be either U32 (unsigned 32-bit integer) or S32 (signed 32-bit integer).

Sd

is a single-precision register for the result.

Dd

is a double-precision register for the result.

Sm

is a single-precision register holding the operand.

Dm

is a double-precision register holding the operand.

Operation

The first two forms of this instruction convert from floating-point to integer.

The third and fourth forms convert from integer to floating-point.

Floating-point exceptions

These instructions can produce Input Denormal, Invalid Operation, or Inexact exceptions.

Related references

[11.8 Condition code suffixes on page 11-319.](#)

13.7 VCVT (between floating-point and fixed-point)

Convert between floating-point and fixed-point numbers.

Syntax

`VCVT{cond}.type.F64 Dd, Dd, #fbits`

`VCVT{cond}.type.F32 Sd, Sd, #fbits`

`VCVT{cond}.F64.type Dd, Dd, #fbits`

`VCVT{cond}.F32.type Sd, Sd, #fbits`

where:

cond

is an optional condition code.

type

can be any one of:

S16

16-bit signed fixed-point number.

U16

16-bit unsigned fixed-point number.

S32

32-bit signed fixed-point number.

U32

32-bit unsigned fixed-point number.

Sd

is a single-precision register for the operand and result.

Dd

is a double-precision register for the operand and result.

fbits

is the number of fraction bits in the fixed-point number, in the range 0-16 if *type* is S16 or U16, or in the range 1-32 if *type* is S32 or U32.

Operation

The first two forms of this instruction convert from floating-point to fixed-point.

The third and fourth forms convert from fixed-point to floating-point.

In all cases the fixed-point number is contained in the least significant 16 or 32 bits of the register.

Floating-point exceptions

These instructions can produce Input Denormal, Invalid Operation, or Inexact exceptions.

Related references

[11.8 Condition code suffixes](#) on page 11-319.

13.8 VCVTB, VCVTT (half-precision extension)

Convert between half-precision and single-precision floating-point numbers.

Syntax

`VCVTB{cond}.type Sd, Sm`

`VCVTT{cond}.type Sd, Sm`

where:

cond

is an optional condition code.

type

can be any one of:

F32.F16

Convert from half-precision to single-precision.

F16.F32

Convert from single-precision to half-precision.

Sd

is a single word register for the result.

Sm

is a single word register for the operand.

Operation

VCVTB uses the bottom half (bits[15:0]) of the single word register to obtain or store the half-precision value

VCVTT uses the top half (bits[31:16]) of the single word register to obtain or store the half-precision value.

Architectures

The instructions are only available in VFPv3 systems with the half-precision extension, and VFPv4.

Floating-point exceptions

These instructions can produce Input Denormal, Invalid Operation, Overflow, Underflow, or Inexact exceptions.

Related references

[11.8 Condition code suffixes](#) on page 11-319.

13.9 VDIV

Floating-point divide.

Syntax

`VDIV{cond}.F32 {Sd}, Sn, Sm`

`VDIV{cond}.F64 {Dd}, Dn, Dm`

where:

cond

is an optional condition code.

Sd, Sn, Sm

are the single-precision registers for the result and operands.

Dd, Dn, Dm

are the double-precision registers for the result and operands.

Operation

The VDIV instruction divides the value in the first operand register by the value in the second operand register, and places the result in the destination register.

Floating-point exceptions

VDIV operations can produce Division by Zero, Invalid Operation, Overflow, Underflow, or Inexact exceptions.

Related references

[11.8 Condition code suffixes](#) on page 11-319.

13.10 VFMA, VFMS, VFNMA, VFNMS (floating-point)

Fused floating-point multiply accumulate and fused floating-point multiply subtract, with optional negation.

Syntax

$VF\{N\}op\{cond\}.F64 \{Dd\}, Dn, Dm$

$VF\{N\}op\{cond\}.F32 \{Sd\}, Sn, Sm$

where:

op

is one of MA or MS.

N

negates the final result.

cond

is an optional condition code.

Sd, Sn, Sm

are the single-precision registers for the result and operands.

Dd, Dn, Dm

are the double-precision registers for the result and operands.

Operation

VFMA multiplies the values in the operand registers, adds the value in the destination register, and places the final result in the destination register. The result of the multiply is not rounded before the accumulation.

VFMS multiplies the values in the operand registers, subtracts the product from the value in the destination register, and places the final result in the destination register. The result of the multiply is not rounded before the subtraction.

In each case, the final result is negated if the N option is used.

Floating-point exceptions

These instructions can produce Input Denormal, Invalid Operation, Overflow, Underflow, or Inexact exceptions.

Related references

[13.23 VMUL \(floating-point\) on page 13-737.](#)

[11.8 Condition code suffixes on page 11-319.](#)

13.11 VLDM (floating-point)

Extension register load multiple.

Syntax

`VLDM $mode\{cond\}$ $Rn\{!\}$, Registers`

where:

mode

must be one of:

IA

meaning Increment address After each transfer. IA is the default, and can be omitted.

DB

meaning Decrement address Before each transfer.

EA

meaning Empty Ascending stack operation. This is the same as DB for loads.

FD

meaning Full Descending stack operation. This is the same as IA for loads.

cond

is an optional condition code.

Rn

is the ARM register holding the base address for the transfer.

!

is optional. **!** specifies that the updated base address must be written back to *Rn*. If **!** is not specified, *mode* must be IA.

Registers

is a list of consecutive extension registers enclosed in braces, { and }. The list can be comma-separated, or in range format. There must be at least one register in the list.

You can specify S or D registers, but they must not be mixed. The number of registers must not exceed 16 D registers.

Note

VPOP *Registers* is equivalent to VLDM *sp!*, *Registers*.

You can use either form of this instruction. They both disassemble to VPOP.

Related concepts

[4.15 Stack implementation using LDM and STM on page 4-82.](#)

Related references

[11.8 Condition code suffixes on page 11-319.](#)

13.12 VLDR (floating-point)

Extension register load.

Syntax

`VLDR{cond}{.size} Fd, [Rn{, #offset}]`

`VLDR{cond}{.size} Fd, Label`

where:

cond

is an optional condition code.

size

is an optional data size specifier. Must be 32 if *Fd* is an S register, or 64 otherwise.

Fd

is the extension register to be loaded, and can be either a D or S register.

Rn

is the ARM register holding the base address for the transfer.

offset

is an optional numeric expression. It must evaluate to a numeric value at assembly time. The value must be a multiple of 4, and lie in the range -1020 to $+1020$. The value is added to the base address to form the address used for the transfer.

Label

is a PC-relative expression.

Label must be aligned on a word boundary within $\pm 1\text{KB}$ of the current instruction.

Operation

The VLDR instruction loads an extension register from memory.

One word is transferred if *Fd* is an S register. Two words are transferred otherwise.

There is also a VLDR pseudo-instruction.

Related concepts

[7.5 Register-relative and PC-relative expressions on page 7-142.](#)

Related references

[13.14 VLDR pseudo-instruction on page 13-728.](#)

[11.8 Condition code suffixes on page 11-319.](#)

13.13 VLDR (post-increment and pre-decrement, floating-point)

Pseudo-instruction that loads extension registers, with post-increment and pre-decrement forms.

————— **Note** —————

There are also VLDR and VSTR instructions without post-increment and pre-decrement.

Syntax

`VLDR{cond}{.size} Fd, [Rn], #offset ; post-increment`

`VLDR{cond}{.size} Fd, [Rn, #-offset]! ; pre-decrement`

where:

cond

is an optional condition code.

size

is an optional data size specifier. Must be 32 if *Fd* is an S register, or 64 if *Fd* is a D register.

Fd

is the extension register to load. It can be either a double precision (*Dd*) or a single precision (*Sd*) register.

Rn

is the ARM register holding the base address for the transfer.

offset

is a numeric expression that must evaluate to a numeric value at assembly time. The value must be 4 if *Fd* is an S register, or 8 if *Fd* is a D register.

Operation

The post-increment instruction increments the base address in the register by the offset value, after the transfer. The pre-decrement instruction decrements the base address in the register by the offset value, and then performs the transfer using the new address in the register. This pseudo-instruction assembles to a VLDM instruction.

Related references

[13.11 VLDM \(floating-point\)](#) on page 13-725.

[13.12 VLDR \(floating-point\)](#) on page 13-726.

[11.8 Condition code suffixes](#) on page 11-319.

13.14 VLDR pseudo-instruction

Pseudo-instruction that loads a constant value into a VFP single-precision or double-precision register.

————— **Note** —————

This section describes the VLDR pseudo-instruction only.

Syntax

`VLDR{cond}.datatype Dd,=constant`

`VLDR{cond}.datatype Sd,=constant`

where:

datatype

must be either F32 or F64.

n

must be one of 8, 16, 32, or 64.

cond

is an optional condition code.

Dd or *Sd*

is the extension register to be loaded.

constant

is an immediate value of the appropriate type for *datatype*.

Operation

If an instruction (for example, `VMOV`) is available that can generate the constant directly into the register, the assembler uses it. Otherwise, the assembler generates a doubleword literal pool entry containing the constant and loads the constant using a VLDR instruction.

Related concepts

[9.9 VFP data types](#) on page 9-200.

Related references

[13.12 VLDR \(floating-point\)](#) on page 13-726.

[11.8 Condition code suffixes](#) on page 11-319.

13.15 VMLA (floating-point)

Floating-point multiply accumulate.

Syntax

`VMLA{cond}.F32 Sd, Sn, Sm`

`VMLA{cond}.F64 Dd, Dn, Dm`

where:

cond

is an optional condition code.

Sd, Sn, Sm

are the single-precision registers for the result and operands.

Dd, Dn, Dm

are the double-precision registers for the result and operands.

Operation

The VMLA instruction multiplies the values in the operand registers, adds the value in the destination register, and places the final result in the destination register.

Floating-point exceptions

This instruction can produce Invalid Operation, Overflow, Underflow, Inexact, or Input Denormal exceptions.

Related references

[11.8 Condition code suffixes](#) on page 11-319.

13.16 VMLS (floating-point)

Floating-point multiply subtract.

Syntax

VMLS{*cond*}.F32 *Sd*, *Sn*, *Sm*

VMLS{*cond*}.F64 *Dd*, *Dn*, *Dm*

where:

cond

is an optional condition code.

Sd, *Sn*, *Sm*

are the single-precision registers for the result and operands.

Dd, *Dn*, *Dm*

are the double-precision registers for the result and operands.

Operation

The VMLS instruction multiplies the values in the operand registers, subtracts the result from the value in the destination register, and places the final result in the destination register.

Floating-point exceptions

This instruction can produce Invalid Operation, Overflow, Underflow, Inexact, or Input Denormal exceptions.

Related references

[11.8 Condition code suffixes](#) on page 11-319.

13.17 VMOV (floating-point)

Insert a floating-point immediate value into a single-precision or double-precision register, or copy one register into another register. This instruction is always scalar.

Syntax

VMOV{*cond*}.F32 *Sd*, #*imm*

VMOV{*cond*}.F64 *Dd*, #*imm*

VMOV{*cond*}.F32 *Sd*, *Sm*

VMOV{*cond*}.F64 *Dd*, *Dm*

where:

cond

is an optional condition code.

Sd

is the single-precision destination register.

Dd

is the double-precision destination register.

imm

is the floating-point immediate value.

Sm

is the single-precision source register.

Dm

is the double-precision source register.

Immediate values

Any number that can be expressed as $\pm n * 2^{-r}$, where n and r are integers, $16 \leq n \leq 31$, $0 \leq r \leq 7$.

Architectures

The instructions that copy immediate constants are available in VFPv3 and above.

The instructions that copy from registers are available in all VFP systems.

Related references

[11.8 Condition code suffixes on page 11-319.](#)

[11.8 Condition code suffixes on page 11-319.](#)

13.18 VMOV (between one ARM register and single precision VFP)

Transfer contents between a single-precision floating-point register and an ARM register.

Syntax

VMOV{*cond*} *Rd*, *Sn*

VMOV{*cond*} *Sn*, *Rd*

where:

cond

is an optional condition code.

Sn

is the VFP single-precision register.

Rd

is the ARM register. *Rd* must not be PC.

Operation

VMOV *Rd*, *Sn* transfers the contents of *Sn* into *Rd*.

VMOV *Sn*, *Rd* transfers the contents of *Rd* into *Sn*.

Related references

[11.8 Condition code suffixes on page 11-319.](#)

13.19 VMOV (between two ARM registers and one or two extension registers)

Transfer contents between two ARM registers and either one 64-bit register or two consecutive 32-bit registers.

Syntax

`VMOV{cond} Dm, Rd, Rn`

`VMOV{cond} Rd, Rn, Dm`

`VMOV{cond} Sm, Sm1, Rd, Rn`

`VMOV{cond} Rd, Rn, Sm, Sm1`

where:

cond

is an optional condition code.

Dm

is a 64-bit extension register.

Sm

is a VFP 32-bit register.

Sm1

is the next consecutive VFP 32-bit register after *Sm*.

Rd, Rn

are the ARM registers. *Rd* and *Rn* must not be PC.

Operation

`VMOV Dm, Rd, Rn` transfers the contents of *Rd* into the low half of *Dm*, and the contents of *Rn* into the high half of *Dm*.

`VMOV Rd, Rn, Dm` transfers the contents of the low half of *Dm* into *Rd*, and the contents of the high half of *Dm* into *Rn*.

`VMOV Rd, Rn, Sm, Sm1` transfers the contents of *Sm* into *Rd*, and the contents of *Sm1* into *Rn*.

`VMOV Sm, Sm1, Rd, Rn` transfers the contents of *Rd* into *Sm*, and the contents of *Rn* into *Sm1*.

Architectures

The instructions are available in VFPv2 and above.

Related references

[11.8 Condition code suffixes on page 11-319.](#)

13.20 VMOV (between an ARM register and half a double precision VFP register)

Transfer contents between an ARM register and half a double precision VFP register.

Syntax

VMOV{*cond*}{*.size*} *Dn[x]*, *Rd*

VMOV{*cond*}{*.size*} *Rd*, *Dn[x]*

where:

cond

is an optional condition code.

size

is the data size. Must be either 32 or omitted. If omitted, *size* is 32.

Dn[x]

if *x* is 0, is the least significant half, or if *x* is 1, the most significant half of a double precision VFP register.

Rd

is the ARM register. *Rd* must not be PC.

Operation

VMOV *Dn[x]*, *Rd* transfers the contents of *Rd* into *Dn[x]*.

VMOV *Rd*, *Dn[x]* transfers the contents of *Dn[x]* into *Rd*.

13.21 VMRS

Transfer the contents of a VFP system register to an ARM register.

Syntax

```
VMRS{cond} Rd, extsysreg
```

where:

cond

is an optional condition code.

extsysreg

is the VFP system register, usually FPSCR, FPSID, or FPEXC.

Rd

is the ARM register. *Rd* must not be PC.

It can be `APSR_nzcv`, if *extsysreg* is FPSCR. In this case, the floating-point status flags are transferred into the corresponding flags in the ARM APSR.

Operation

The VMRS instruction transfers the contents of *extsysreg* into *Rd*.

————— **Note** —————

This instruction stalls the processor until all current VFP operations complete.

Examples

```
VMRS    r2, FPCID
VMRS    APSR_nzcv, FPSCR ; transfer FP status register to ARM APSR
```

Related references

[8.16 NEON system registers on page 8-184.](#)

[11.8 Condition code suffixes on page 11-319.](#)

13.22 VMSR

Transfer the contents of an ARM register to a VFP system register.

Syntax

VMSR{*cond*} *extsysreg*, *Rd*

where:

cond

is an optional condition code.

extsysreg

is the VFP system register, usually FPSCR, FPSID, or FPEXC.

Rd

is the ARM register. *Rd* must not be PC.

Operation

The VMSR instruction transfers the contents of *Rd* into *extsysreg*.

Note

This instruction stalls the processor until all current VFP operations complete.

Example

```
VMSR    FPSCR, r4
```

Related references

[8.16 NEON system registers](#) on page 8-184.

[11.8 Condition code suffixes](#) on page 11-319.

13.23 VMUL (floating-point)

Floating-point multiply.

Syntax

`VMUL{cond}.F32 {Sd,} Sn, Sm`

`VMUL{cond}.F64 {Dd,} Dn, Dm`

where:

cond

is an optional condition code.

Sd, Sn, Sm

are the single-precision registers for the result and operands.

Dd, Dn, Dm

are the double-precision registers for the result and operands.

Operation

The VMUL operation multiplies the values in the operand registers and places the result in the destination register.

Floating-point exceptions

This instruction can produce Invalid Operation, Overflow, Underflow, Inexact, or Input Denormal exceptions.

Related references

[11.8 Condition code suffixes](#) on page 11-319.

13.24 VNEG (floating-point)

Floating-point negate.

Syntax

VNEG{*cond*}.F32 *Sd*, *Sm*

VNEG{*cond*}.F64 *Dd*, *Dm*

where:

cond

is an optional condition code.

Sd, *Sm*

are the single-precision registers for the result and operand.

Dd, *Dm*

are the double-precision registers for the result and operand.

Operation

The VNEG instruction takes the contents of *Sm* or *Dm*, changes the sign bit, and places the result in *Sd* or *Dd*. This gives the negation of the value.

If the operand is a NaN, the sign bit is changed, but no exception is produced.

Floating-point exceptions

VNEG instructions do not produce any exceptions.

Related references

[11.8 Condition code suffixes](#) on page 11-319.

13.25 VNMLA (floating-point)

Floating-point multiply accumulate with negation.

Syntax

VNMLA{*cond*}.F32 *Sd*, *Sn*, *Sm*

VNMLA{*cond*}.F64 *Dd*, *Dn*, *Dm*

where:

cond

is an optional condition code.

Sd, *Sn*, *Sm*

are the single-precision registers for the result and operands.

Dd, *Dn*, *Dm*

are the double-precision registers for the result and operands.

Operation

The VNMLA instruction multiplies the values in the operand registers, adds the value to the destination register, and places the negated final result in the destination register.

Floating-point exceptions

This instruction can produce Invalid Operation, Overflow, Underflow, Inexact, or Input Denormal exceptions.

Related references

[11.8 Condition code suffixes](#) on page 11-319.

13.26 VNMLS (floating-point)

Floating-point multiply subtract with negation.

Syntax

VNMLS{*cond*}.F32 *Sd*, *Sn*, *Sm*

VNMLS{*cond*}.F64 *Dd*, *Dn*, *Dm*

where:

cond

is an optional condition code.

Sd, *Sn*, *Sm*

are the single-precision registers for the result and operands.

Dd, *Dn*, *Dm*

are the double-precision registers for the result and operands.

Operation

The VNMLS instruction multiplies the values in the operand registers, subtracts the result from the value in the destination register, and places the negated final result in the destination register.

Floating-point exceptions

This instruction can produce Invalid Operation, Overflow, Underflow, Inexact, or Input Denormal exceptions.

Related references

[11.8 Condition code suffixes](#) on page 11-319.

13.27 VNMUL (floating-point)

Floating-point multiply with negation.

Syntax

VNMUL{*cond*}.F32 {*Sd*,} *Sn*, *Sm*

VNMUL{*cond*}.F64 {*Dd*,} *Dn*, *Dm*

where:

cond

is an optional condition code.

Sd, *Sn*, *Sm*

are the single-precision registers for the result and operands.

Dd, *Dn*, *Dm*

are the double-precision registers for the result and operands.

Operation

The VNMUL instruction multiplies the values in the operand registers and places the negated result in the destination register.

Floating-point exceptions

This instruction can produce Invalid Operation, Overflow, Underflow, Inexact, or Input Denormal exceptions.

Related references

[11.8 Condition code suffixes](#) on page 11-319.

13.28 VPOP (floating-point)

Pop extension registers from the stack.

Syntax

VPOP{*cond*} *Registers*

where:

cond

is an optional condition code.

Registers

is a list of consecutive extension registers enclosed in braces, { and }. The list can be comma-separated, or in range format. There must be at least one register in the list.

You can specify S or D registers, but they must not be mixed. The number of registers must not exceed 16 D registers.

Note

VPOP *Registers* is equivalent to VLDM *sp!*, *Registers*.

You can use either form of this instruction. They both disassemble to VPOP.

Related concepts

[4.15 Stack implementation using LDM and STM](#) on page 4-82.

Related references

[11.8 Condition code suffixes](#) on page 11-319.

[13.29 VPUSH \(floating-point\)](#) on page 13-743.

13.29 V PUSH (floating-point)

Push extension registers onto the stack.

Syntax

V PUSH{*cond*} *Registers*

where:

cond

is an optional condition code.

Registers

is a list of consecutive extension registers enclosed in braces, { and }. The list can be comma-separated, or in range format. There must be at least one register in the list.

You can specify S or D registers, but they must not be mixed. The number of registers must not exceed 16 D registers.

Note

V PUSH *Registers* is equivalent to V STMDB *sp!*, *Registers*.

You can use either form of this instruction. They both disassemble to V PUSH.

Related concepts

[4.15 Stack implementation using LDM and STM](#) on page 4-82.

Related references

[11.8 Condition code suffixes](#) on page 11-319.

[13.28 V POP \(floating-point\)](#) on page 13-742.

13.30 VSQRT

Floating-point square root.

Syntax

`VSQRT{cond}.F32 Sd, Sm`

`VSQRT{cond}.F64 Dd, Dm`

where:

cond

is an optional condition code.

Sd, Sm

are the single-precision registers for the result and operand.

Dd, Dm

are the double-precision registers for the result and operand.

Operation

The VSQRT instruction takes the square root of the contents of *Sm* or *Dm*, and places the result in *Sd* or *Dd*.

Floating-point exceptions

VSQRT instructions can produce Invalid Operation or Inexact exceptions.

Related references

[11.8 Condition code suffixes](#) on page 11-319.

13.31 VSTM (floating-point)

Extension register store multiple.

Syntax

`VSTMmode{cond} Rn{!}, Registers`

where:

mode

must be one of:

IA

meaning Increment address After each transfer. IA is the default, and can be omitted.

DB

meaning Decrement address Before each transfer.

EA

meaning Empty Ascending stack operation. This is the same as IA for stores.

FD

meaning Full Descending stack operation. This is the same as DB for stores.

cond

is an optional condition code.

Rn

is the ARM register holding the base address for the transfer.

!

is optional. ! specifies that the updated base address must be written back to *Rn*. If ! is not specified, *mode* must be IA.

Registers

is a list of consecutive extension registers enclosed in braces, { and }. The list can be comma-separated, or in range format. There must be at least one register in the list.

You can specify S or D registers, but they must not be mixed. The number of registers must not exceed 16 D registers.

Note

`VPUSH Registers` is equivalent to `VSTMDB sp!, Registers`.

You can use either form of this instruction. They both disassemble to `VPUSH`.

Related concepts

[4.15 Stack implementation using LDM and STM on page 4-82.](#)

Related references

[11.8 Condition code suffixes on page 11-319.](#)

13.32 VSTR (floating-point)

Extension register store.

Syntax

VSTR{*cond*}{*.size*} *Fd*, [*Rn*{, #*offset*}]

where:

cond

is an optional condition code.

size

is an optional data size specifier. Must be 32 if *Fd* is an S register, or 64 otherwise.

Fd

is the extension register to be saved. It can be either a D or S register.

Rn

is the ARM register holding the base address for the transfer.

offset

is an optional numeric expression. It must evaluate to a numeric value at assembly time. The value must be a multiple of 4, and lie in the range –1020 to +1020. The value is added to the base address to form the address used for the transfer.

Operation

The VSTR instruction saves the contents of an extension register to memory.

One word is transferred if *Fd* is an S register. Two words are transferred otherwise.

Related concepts

[7.5 Register-relative and PC-relative expressions on page 7-142.](#)

Related references

[13.14 VLDR pseudo-instruction on page 13-728.](#)

[11.8 Condition code suffixes on page 11-319.](#)

13.33 VSTR (post-increment and pre-decrement, floating-point)

Pseudo-instruction that stores extension registers with post-increment and pre-decrement forms.

————— **Note** —————

There are also VLDR and VSTR instructions without post-increment and pre-decrement.

Syntax

VSTR{*cond*}{*.size*} *Fd*, [*Rn*], #*offset* ; post-increment

VSTR{*cond*}{*.size*} *Fd*, [*Rn*, #-*offset*]! ; pre-decrement

where:

cond

is an optional condition code.

size

is an optional data size specifier. Must be 32 if *Fd* is an S register, or 64 if *Fd* is a D register.

Fd

is the extension register to be saved. It can be either a double precision (*Dd*) or a single precision (*Sd*) register.

Rn

is the ARM register holding the base address for the transfer.

offset

is a numeric expression that must evaluate to a numeric value at assembly time. The value must be 4 if *Fd* is an S register, or 8 if *Fd* is a D register.

Operation

The post-increment instruction increments the base address in the register by the offset value, after the transfer. The pre-decrement instruction decrements the base address in the register by the offset value, and then performs the transfer using the new address in the register. This pseudo-instruction assembles to a VSTM instruction.

Related references

[13.32 VSTR \(floating-point\)](#) on page 13-746.

[13.31 VSTM \(floating-point\)](#) on page 13-745.

[11.8 Condition code suffixes](#) on page 11-319.

13.34 VSUB (floating-point)

Floating-point subtract.

Syntax

`VSUB{cond}.F32 {Sd}, Sn, Sm`

`VSUB{cond}.F64 {Dd}, Dn, Dm`

where:

cond

is an optional condition code.

Sd, Sn, Sm

are the single-precision registers for the result and operands.

Dd, Dn, Dm

are the double-precision registers for the result and operands.

Operation

The VSUB instruction subtracts the value in the second operand register from the value in the first operand register, and places the result in the destination register.

Floating-point exceptions

The VSUB instruction can produce Invalid Operation, Overflow, or Inexact exceptions.

Related references

[11.8 Condition code suffixes](#) on page 11-319.

Chapter 14

Wireless MMX Technology Instructions

Describes the support for Wireless MMX Technology instructions.

It contains the following sections:

- *14.1 About Wireless MMX Technology instructions on page 14-750.*
- *14.2 WRN and WCN directives to support Wireless MMX Technology on page 14-751.*
- *14.3 Frame directives and Wireless MMX Technology on page 14-752.*
- *14.4 Wireless MMX load and store instructions on page 14-753.*
- *14.5 Wireless MMX Technology and XScale instructions on page 14-755.*
- *14.6 Wireless MMX instructions on page 14-756.*
- *14.7 Wireless MMX pseudo-instructions on page 14-758.*

14.1 About Wireless MMX Technology instructions

Marvell Wireless MMX Technology is a set of *Single Instruction Multiple Data* (SIMD) instructions available on selected XScale processors that improve the performance of some multimedia applications.

Wireless MMX Technology uses 64-bit registers to enable it to operate on multiple data elements in a packed format.

The assembler supports Marvell Wireless MMX Technology instructions to assemble code to run on the PXA270 processor. This processor implements the ARMv5TE architecture, with MMX extensions. Wireless MMX Technology uses ARM coprocessors 0 and 1 to support its instruction set and data types. ARM Compiler toolchain supports Wireless MMX Technology Control and *Single Instruction Multiple Data* (SIMD) Data registers, and include new directives for Wireless MMX Technology development. There is also enhanced support for load and store instructions.

When using the assembler, be aware that:

- Wireless MMX Technology instructions are only assembled if you specify the supported processor (armasm --cpu PXA270).
- The PXA270 processor supports code written in ARM or Thumb only.
- Most Wireless MMX Technology instructions can be executed conditionally, depending on the state of the ARM flags. The Wireless MMX Technology condition codes are identical to the ARM condition codes.

Wireless MMX 2 Technology is an upgraded version of Wireless MMX Technology.

This documentation contains information on the Wireless MMX Technology support provided by the assembler in the ARM Compiler toolchain. It does not provide a detailed description of the Wireless MMX Technology. *Wireless MMX Technology Developer Guide* contains information about the programmers' model and a full description of the Wireless MMX Technology instruction set.

Related concepts

[14.3 Frame directives and Wireless MMX Technology on page 14-752.](#)

[14.5 Wireless MMX Technology and XScale instructions on page 14-755.](#)

Related references

[14.2 WRN and WCN directives to support Wireless MMX Technology on page 14-751.](#)

[14.4 Wireless MMX load and store instructions on page 14-753.](#)

Related information

[Further reading.](#)

14.2 WRN and WCN directives to support Wireless MMX Technology

The assembler supports directives that define names for Wireless MMX Technology registers.

The following directives are available to support Wireless MMX Technology:

WCN

Defines a name for a specified Control register, for example:

```
speed WCN wcsr0 ; defines speed as a symbol for control reg 0
```

WRN

Defines a name for a specified SIMD Data register, for example:

```
rate WRN wr6 ; defines rate as a symbol for data reg 6
```

Avoid conflicting uses of the same register under different names. Do not use any of the predefined register and coprocessor names.

Related concepts

[14.1 About Wireless MMX Technology instructions on page 14-750.](#)

14.3 Frame directives and Wireless MMX Technology

Wireless MMX Technology registers can be used with `FRAME` directives in the same way as ARM registers to add debug information into your object files.

Be aware of the following restrictions:

- A warning is given if you try to push Wireless MMX Technology registers `wR0 - wR9` or `wCGR0 - wCGR3` onto the stack.
- Wireless MMX Technology registers cannot be used as address offsets.

Related concepts

[14.1 About Wireless MMX Technology instructions on page 14-750.](#)

14.4 Wireless MMX load and store instructions

Load and store a byte, halfword, word, or doubleword to and from Wireless MMX coprocessor registers.

Syntax

```

op<type>{cond} wRd, [Rn, #-offset]{!}
op<type>{cond} wRd, [Rn] {, #-offset}
opW{cond} wRd, Label
opW wCd, [Rn, #-offset]{!}
opW wCd, [Rn] {, #-offset}
opD {cond} wRd, Label
opD wRd, [Rn, {-}Rm {, LSL #imm4}]{!} ; MMX2 only
opD wRd, [Rn], {-}Rm {, LSL #imm4} ; MMX2 only
  
```

where:

op

can be either:

WLDR Load Wireless MMX Register.
WSTR Store Wireless MMX Register.

<type>

can be any one of:

B Byte.
H Halfword.
W Word.
D Doubleword.

cond

is an optional condition code.

wRd

is the Wireless MMX SIMD data register to load or save.

wCd

is the Wireless MMX Status and Control register to load or save.

Rn

is the register on which the memory address is based.

offset

is an immediate offset. If offset is omitted, the instruction is a zero offset instruction.

!

is an optional suffix. If ! is present, the instruction is a pre-indexed instruction.

Label

is a PC-relative expression.

Label must be within ± 1020 bytes of the current instruction.

Rm

is a register containing a value to be used as the offset. *Rm* must not be PC.

imm4

contains the number of bits to shift *Rm* left, in the range 0-15.

Loading constants into SIMD registers

The assembler also supports the WLDW and WLDL literal load pseudo-instructions, for example:

```
WLDW wr0, =0x114
```

Be aware that:

- The assembler cannot load byte and halfword literals. These produce a downgradable error. If downgraded, the instruction is converted to a WLDW and a 32-bit literal is generated. This is the same as a byte literal load, but uses a 32-bit word instead.
- If the literal to be loaded is zero, and the destination is a SIMD Data register, the assembler converts the instruction to a WZERO.
- Doubleword loads must be 8-byte aligned.

Related concepts

[14.1 About Wireless MMX Technology instructions on page 14-750.](#)

14.5 Wireless MMX Technology and XScale instructions

Wireless MMX Technology instructions overlap with XScale instructions. To avoid conflicts, the assembler has some restrictions.

The following restrictions apply:

- You cannot mix the XScale instructions with Wireless MMX Technology instructions in the same assembly.
- Wireless MMX Technology TMIA instructions have a MIA mnemonic that overlaps with the XScale MIA instructions. Be aware that:
 - MIA *acc0*, *Rm*, *Rs* is accepted in XScale, but faulted in Wireless MMX Technology.
 - MIA *wR0*, *Rm*, *Rs* and TMIA *wR0*, *Rm*, *Rs* are accepted in Wireless MMX Technology.
 - TMIA *acc0*, *Rm*, *Rs* is faulted in XScale (XScale has no TMIA instruction).

Related concepts

[7.5 Register-relative and PC-relative expressions](#) on page 7-142.

Related references

[2.13 Predeclared XScale register names](#) on page 2-48.

[11.54 MIA, MIAPH, and MIAxy](#) on page 11-399.

[11.51 MAR](#) on page 11-396.

[15.3 About frame directives](#) on page 15-763.

[15.32 FRAME PUSH](#) on page 15-796.

[15.30 FRAME ADDRESS](#) on page 15-794.

[15.35 FRAME RETURN ADDRESS](#) on page 15-799.

[11.8 Condition code suffixes](#) on page 11-319.

14.6 Wireless MMX instructions

Wireless MMX technology provides an instruction set that operates on ARM and Wireless MMX technology registers.

The following table gives a list of the Wireless MMX Technology instruction set. The instructions are described in *Wireless MMX Technology Developer Guide*. Wireless MMX Technology registers are indicated by *wRn*, *wRd*, and ARM registers are shown as *Rn*, *Rd*.

Table 14-1 Wireless MMX Technology instructions

Mnemonic	Example
TANDC	TANDCB r15
TBCST	TBCSTB wr15, r1
TEXTRC	TEXTRCB r15, #0
TEXTRM	TEXTRMUBCS r3, wr7, #7
TINSR	TINSRB wr6, r11, #0
TMIA, TMIAPH, TMIAxy	TMIANE wr1, r2, r3 TMIAPH wr4, r5, r6 TMIABB wr4, r5, r6 MIAPHNE wr4, r5, r6
TMOVMSK	TMOVMSKBNE r14, wr15
TORC	TORCB r15
WACC	WACCBGE wr1, wr2
WADD	WADDBGE wr1, wr2, wr13
WALIGNI, WALIGNR	WALIGNI wr7, wr6, wr5, #3 WALIGNR0 wr4, wr8, wr12
WAND, WANDN	WAND wr1, wr2, wr3 WANDN wr5, wr5, wr9
WAVG2	WAVG2B wr3, wr6, wr9 WAVG2BR wr4, wr7, wr10
WCMPEQ	WCMPEQB wr0, wr4, wr2
WCMPGT	WCMPGTUB wr0, wr4, wr2
WLDR	WLDRB wr1, [r2, #0]
WMAC	WMACU wr3, wr4, wr5
WMADD	WMADDU wr3, wr4, wr5
WMAX, WMIN	WMAXUB wr0, wr4, wr2 WMINSB wr0, wr4, wr2
WMUL	WMULUL wr4, wr2, wr3

Table 14-1 Wireless MMX Technology instructions (continued)

Mnemonic	Example
WOR	WOR wr3, wr1, wr4
WPACK	WPACKHUS wr2, wr7, wr1
WROR	WRORH wr3, wr1, wr4
WSAD	WSADB wr3, wr5, wr8
WSHUFH	WSHUFH wr8, wr15, #17
WSLL, WSRL	WSLLH wr3, wr1, wr4 WSRLHG wr3, wr1, wcgr0
WSRA	WSRAH wr3, wr1, wr4 WSRAHG wr3, wr1, wcgr0
WSTR	WSTRB wr1, [r2, #0] WSTRW wc1, [r2, #0]
WSUB	WSUBBGE wr1, wr2, wr13
WUNPCKEH, WUNPCKEL	WUNPCKEHUB wr0, wr4 WUNPCKELSB wr0, wr4
WUNPCKIH, WUNPCKIL	WUNPCKIHB wr0, wr4, wr2 WUNPCKILH wr1, wr5, wr3
WXOR	WXOR wr3, wr1, wr4

Related concepts

14.1 About Wireless MMX Technology instructions on page 14-750.

Related references

14.7 Wireless MMX pseudo-instructions on page 14-758.

Related information

Further reading.

14.7 Wireless MMX pseudo-instructions

Wireless MMX technology provides a set of pseudo-instructions that operate on ARM and Wireless MMX technology registers.

The following table gives an overview of the Wireless MMX Technology pseudo-instructions. These instructions are described in the *Wireless MMX Technology Developer Guide*.

Table 14-2 Wireless MMX Technology pseudo-instructions

Mnemonic	Brief description	Example
TMCR	Moves the contents of source register, <i>Rn</i> , to Control register, <i>wCn</i> . Maps onto the ARM MCR coprocessor instruction.	TMCR <i>wc1, r10</i>
TMCRR	Moves the contents of two source registers, <i>RnLo</i> and <i>RnHi</i> , to destination register, <i>wRd</i> . Do not use R15 for either <i>RnLo</i> or <i>RnHi</i> . Maps onto the ARM MCRR coprocessor instruction.	TMCRR <i>wr4, r5,</i> <i>r6</i>
TMRC	Moves the contents of Control register, <i>wCn</i> , to destination register, <i>Rd</i> . Do not use R15 for <i>Rd</i> . Maps onto the ARM MRC coprocessor instruction.	TMRC <i>r1, wc2</i>
TMRRC	Moves the contents of source register, <i>wRn</i> , to two destination registers, <i>RdLo</i> and <i>RdHi</i> . Do not use R15 for either destination register. <i>RdLo</i> and <i>RdHi</i> must be distinct registers. Maps onto the ARM MRRC coprocessor instruction.	TMRRC <i>r1, r0,</i> <i>wr2</i>
WMOV	Moves the contents of source register, <i>wRn</i> , to destination register, <i>wRd</i> . This instruction is a form of WOR.	WMOV <i>wr1, wr8</i>
WZERO	Zeros destination register, <i>wRd</i> . This instruction is a form of WANDN.	WZERO <i>wr1</i>

Related references

[11.52 MCR and MCR2](#) on page 11-397.

[11.53 MCRR and MCRR2](#) on page 11-398.

[11.61 MRC and MRC2](#) on page 11-408.

[11.62 MRRC and MRRC2](#) on page 11-409.

[14.6 Wireless MMX instructions](#) on page 14-756.

Chapter 15

Directives Reference

Describes the directives that are provided by the ARM assembler, `armasm`.

Note

None of these directives are available in the inline assemblers in the ARM C and C++ compilers.

It contains the following sections:

- [15.1 Alphabetical list of directives](#) on page 15-761.
- [15.2 About assembly control directives](#) on page 15-762.
- [15.3 About frame directives](#) on page 15-763.
- [15.4 ALIAS](#) on page 15-764.
- [15.5 ALIGN](#) on page 15-765.
- [15.6 AREA](#) on page 15-767.
- [15.7 ARM or CODE32](#) on page 15-770.
- [15.8 ASSERT](#) on page 15-771.
- [15.9 ATTR](#) on page 15-772.
- [15.10 CN](#) on page 15-773.
- [15.11 CODE16](#) on page 15-774.
- [15.12 COMMON](#) on page 15-775.
- [15.13 CP](#) on page 15-776.
- [15.14 DATA](#) on page 15-777.
- [15.15 DCB](#) on page 15-778.
- [15.16 DCD and DCDD](#) on page 15-779.
- [15.17 DCDO](#) on page 15-780.
- [15.18 DCFD and DCFDU](#) on page 15-781.
- [15.19 DCFS and DCFSU](#) on page 15-782.

- 15.20 *DCI* on page 15-783.
- 15.21 *DCQ* and *DCQU* on page 15-784.
- 15.22 *DCW* and *DCWU* on page 15-785.
- 15.23 *END* on page 15-786.
- 15.24 *ENDFUNC* or *ENDP* on page 15-787.
- 15.25 *ENTRY* on page 15-788.
- 15.26 *EQU* on page 15-789.
- 15.27 *EXPORT* or *GLOBAL* on page 15-790.
- 15.28 *EXPORTAS* on page 15-792.
- 15.29 *FIELD* on page 15-793.
- 15.30 *FRAME ADDRESS* on page 15-794.
- 15.31 *FRAME POP* on page 15-795.
- 15.32 *FRAME PUSH* on page 15-796.
- 15.33 *FRAME REGISTER* on page 15-797.
- 15.34 *FRAME RESTORE* on page 15-798.
- 15.35 *FRAME RETURN ADDRESS* on page 15-799.
- 15.36 *FRAME SAVE* on page 15-800.
- 15.37 *FRAME STATE REMEMBER* on page 15-801.
- 15.38 *FRAME STATE RESTORE* on page 15-802.
- 15.39 *FRAME UNWIND ON* on page 15-803.
- 15.40 *FRAME UNWIND OFF* on page 15-804.
- 15.41 *FUNCTION* or *PROC* on page 15-805.
- 15.42 *GBLA*, *GBLL*, and *GBLS* on page 15-806.
- 15.43 *GET* or *INCLUDE* on page 15-807.
- 15.44 *IF*, *ELSE*, *ENDIF*, and *ELIF* on page 15-808.
- 15.45 *IMPORT* and *EXTERN* on page 15-810.
- 15.46 *INCBIN* on page 15-812.
- 15.47 *INFO* on page 15-813.
- 15.48 *KEEP* on page 15-814.
- 15.49 *LCLA*, *LCLL*, and *LCLS* on page 15-815.
- 15.50 *LTORG* on page 15-816.
- 15.51 *MACRO* and *MEND* on page 15-817.
- 15.52 *MAP* on page 15-820.
- 15.53 *MEXIT* on page 15-821.
- 15.54 *NOFP* on page 15-822.
- 15.55 *OPT* on page 15-823.
- 15.56 *QN*, *DN*, and *SN* on page 15-825.
- 15.57 *RELOC* on page 15-827.
- 15.58 *REQUIRE* on page 15-828.
- 15.59 *REQUIRE8* and *PRESERVE8* on page 15-829.
- 15.60 *RLIST* on page 15-830.
- 15.61 *RN* on page 15-831.
- 15.62 *ROUT* on page 15-832.
- 15.63 *SETA*, *SETL*, and *SETS* on page 15-833.
- 15.64 *SPACE* or *FILL* on page 15-834.
- 15.65 *THUMB* on page 15-835.
- 15.66 *THUMBX* on page 15-836.
- 15.67 *TTL* and *SUBT* on page 15-837.
- 15.68 *WHILE* and *WEND* on page 15-838.

15.1 Alphabetical list of directives

The ARM assembler, `armasm`, provides various directives.

The following table lists them:

Table 15-1 List of directives

Directive	Directive	Directive
ALIAS	EQU	LTORG
ALIGN	EXPORT or GLOBAL	MACRO and MEND
ARM or CODE32	EXPORTAS	MAP
AREA	EXTERN	MEND (see MACRO)
ASSERT	FIELD	MEXIT
ATTR	FRAME ADDRESS	NOFP
CN	FRAME POP	OPT
CODE16	FRAME PUSH	PRESERVE8 (see REQUIRE8)
COMMON	FRAME REGISTER	PROC see FUNCTION
CP	FRAME RESTORE	QN
DATA	FRAME SAVE	RELOC
DCB	FRAME STATE REMEMBER	REQUIRE
DCD and DCDU	FRAME STATE RESTORE	REQUIRE8 and PRESERVE8
DCDO	FRAME UNWIND ON or OFF	RLIST
DCFD and DCFDU	FUNCTION or PROC	RN
DCFS and DCFSU	GBLA, GBLL, and GBLS	ROUT
DCI	GET or INCLUDE	SETA, SETL, and SETS
-	GLOBAL (see EXPORT)	SN
DCW and DCWU	IF, ELSE, ENDIF, and ELIF	SPACE or FILL
DN	IMPORT	SUBT
ELIF, ELSE (see IF)	INCBIN	THUMB
END	INCLUDE see GET	THUMBX
ENDFUNC or ENDP	INFO	TTL
ENDIF (see IF)	KEEP	WHILE and WEND
ENTRY	LCLA, LCLL, and LCLS	

15.2 About assembly control directives

Some assembler directives control conditional assembly, looping, inclusions, and macros.

These directives are as follows:

- `MACRO` and `MEND`.
- `MEXIT`.
- `IF`, `ELSE`, `ENDIF`, and `ELIF`.
- `WHILE` and `WEND`.

Nesting directives

The following structures can be nested to a total depth of 256:

- `MACRO` definitions.
- `WHILE` . . . `WEND` loops.
- `IF` . . . `ELSE` . . . `ENDIF` conditional structures.
- `INCLUDE` file inclusions.

The limit applies to all structures taken together, regardless of how they are nested. The limit is not 256 of each type of structure.

Related references

[15.51 `MACRO` and `MEND`](#) on page 15-817.

[15.53 `MEXIT`](#) on page 15-821.

[15.44 `IF`, `ELSE`, `ENDIF`, and `ELIF`](#) on page 15-808.

[15.68 `WHILE` and `WEND`](#) on page 15-838.

15.3 About frame directives

Frame directives enable debugging and profiling of assembly language functions. They also enable the stack usage of functions to be calculated.

Correct use of these directives:

- Enables the `armLink --callgraph` option to calculate stack usage of assembler functions. The following are the rules that determine stack usage:
 - If a function is not marked with `PROC` or `ENDP`, stack usage is unknown.
 - If a function is marked with `PROC` or `ENDP` but with no `FRAME PUSH` or `FRAME POP`, stack usage is assumed to be zero. This means that there is no requirement to manually add `FRAME PUSH 0` or `FRAME POP 0`.
 - If a function is marked with `PROC` or `ENDP` and with `FRAME PUSH n` or `FRAME POP n`, stack usage is assumed to be `n` bytes.
- Helps you to avoid errors in function construction, particularly when you are modifying existing code.
- Enables the assembler to alert you to errors in function construction.
- Enables backtracing of function calls during debugging.
- Enables the debugger to profile assembler functions.

If you require profiling of assembler functions, but do not want frame description directives for other purposes:

- You must use the `FUNCTION` and `ENDFUNC`, or `PROC` and `ENDP`, directives.
- You can omit the other `FRAME` directives.
- You only have to use the `FUNCTION` and `ENDFUNC` directives for the functions you want to profile.

In DWARF, the canonical frame address is an address on the stack specifying where the call frame of an interrupted function is located.

Related references

- [15.30 FRAME ADDRESS on page 15-794.](#)
- [15.31 FRAME POP on page 15-795.](#)
- [15.32 FRAME PUSH on page 15-796.](#)
- [15.33 FRAME REGISTER on page 15-797.](#)
- [15.34 FRAME RESTORE on page 15-798.](#)
- [15.35 FRAME RETURN ADDRESS on page 15-799.](#)
- [15.36 FRAME SAVE on page 15-800.](#)
- [15.37 FRAME STATE REMEMBER on page 15-801.](#)
- [15.38 FRAME STATE RESTORE on page 15-802.](#)
- [15.39 FRAME UNWIND ON on page 15-803.](#)
- [15.40 FRAME UNWIND OFF on page 15-804.](#)
- [15.41 FUNCTION or PROC on page 15-805.](#)
- [15.24 ENDFUNC or ENDP on page 15-787.](#)

15.4 ALIAS

The ALIAS directive creates an alias for a symbol.

Syntax

```
ALIAS name, aliasname
```

where:

name

is the name of the symbol to create an alias for.

aliasname

is the name of the alias to be created.

Usage

The symbol *name* must already be defined in the source file before creating an alias for it. Properties of *name* set by the EXPORT directive are not inherited by *aliasname*, so you must use EXPORT on *aliasname* if you want to make the alias available outside the current source file. Apart from the properties set by the EXPORT directive, *name* and *aliasname* are identical.

Correct example

```
baz
bar PROC
    BX lr
    ENDP
    ALIAS bar,foo ; foo is an alias for bar
    EXPORT bar
    EXPORT foo ; foo and bar have identical properties
                ; because foo was created using ALIAS
    EXPORT baz ; baz and bar are not identical
                ; because the size field of baz is not set
```

Incorrect example

```
EXPORT bar
IMPORT car
ALIAS bar,foo ; ERROR - bar is not defined yet
ALIAS car,boo ; ERROR - car is external
bar PROC
    BX lr
    ENDP
```

Related references

[15.27 EXPORT or GLOBAL on page 15-790.](#)

15.5 ALIGN

The ALIGN directive aligns the current location to a specified boundary by padding with zeros or NOP instructions.

Syntax

```
ALIGN {expr{,offset{,pad{,padsize}}}}
```

where:

expr

is a numeric expression evaluating to any power of 2 from 2^0 to 2^{31}

offset

can be any numeric expression

pad

can be any numeric expression

*padsiz*e

can be 1, 2 or 4.

Operation

The current location is aligned to the next lowest address of the form:

$$\textit{offset} + n * \textit{expr}$$

n is any integer which the assembler selects to minimise padding.

If *expr* is not specified, ALIGN sets the current location to the next word (four byte) boundary. The unused space between the previous and the new current location are filled with:

- Copies of *pad*, if *pad* is specified.
- NOP instructions, if all the following conditions are satisfied:
 - *pad* is not specified.
 - The ALIGN directive follows ARM or Thumb instructions.
 - The current section has the CODEALIGN attribute set on the AREA directive.
- Zeros otherwise.

pad is treated as a byte, halfword, or word, according to the value of *padsiz*e. If *padsiz*e is not specified, *pad* defaults to bytes in data sections, halfwords in Thumb code, or words in ARM code.

Usage

Use ALIGN to ensure that your data and code is aligned to appropriate boundaries. This is typically required in the following circumstances:

- The ADR Thumb pseudo-instruction can only load addresses that are word aligned, but a label within Thumb code might not be word aligned. Use ALIGN 4 to ensure four-byte alignment of an address within Thumb code.
- Use ALIGN to take advantage of caches on some ARM processors. For example, the ARM940T has a cache with 16-byte lines. Use ALIGN 16 to align function entries on 16-byte boundaries and maximize the efficiency of the cache.
- In ARMv5TE, or in ARMv6 when SCTL.R.U is 0, LDRD and STRD doubleword data transfers must be eight-byte aligned. Use ALIGN 8 before memory allocation directives such as DCQ if the data is to be accessed using LDRD or STRD. This is not required in ARMv6 when SCTL.R.U is 1, or in ARMv7, because in these versions, doubleword data transfers can be word-aligned.
- A label on a line by itself can be arbitrarily aligned. Following ARM code is word-aligned (Thumb code is halfword aligned). The label therefore does not address the code correctly. Use ALIGN 4 (or ALIGN 2 for Thumb) before the label.

Alignment is relative to the start of the ELF section where the routine is located. The section must be aligned to the same, or coarser, boundaries. The ALIGN attribute on the AREA directive is specified differently.

Examples

```

AREA    cacheable, CODE, ALIGN=3
rout1  ; code          ; aligned on 8-byte boundary
        ; code
        MOV    pc,lr   ; aligned only on 4-byte boundary
rout2  ALIGN    8      ; now aligned on 8-byte boundary
        ; code

```

In the following example, the ALIGN directive tells the assembler that the next instruction is word aligned and offset by 3 bytes. The 3 byte offset is counted from the previous word aligned address, resulting in the second DCB placed in the last byte of the same word and 2 bytes of padding are to be added.

```

AREA    OffsetExample, CODE
DCB    1      ; This example places the two bytes in the first
ALIGN  4,3   ; and fourth bytes of the same word.
DCB    1      ; The second DCB is offset by 3 bytes from the
           ; first DCB.

```

In the following example, the ALIGN directive tells the assembler that the next instruction is word aligned and offset by 2 bytes. Here, the 2 byte offset is counted from the next word aligned address, so the value *n* is set to 1 (*n*=0 clashes with the third DCB). This time three bytes of padding are to be added.

```

AREA    OffsetExample1, CODE
DCB    1      ; In this example, n cannot be 0 because it
DCB    1      ; clashes with the 3rd DCB. The assembler
DCB    1      ; sets n to 1.
ALIGN  4,2   ; The next instruction is word aligned and
DCB    2      ; offset by 2.

```

In the following example, the DCB directive makes the PC misaligned. The ALIGN directive ensures that the label subroutine1 and the following instruction are word aligned.

```

start  AREA    Example, CODE, READONLY
        LDR    r6,=label1
        ; code
        MOV    pc,lr
label1 DCB    1      ; PC now misaligned
        ALIGN  ; ensures that subroutine1 addresses
subroutine1 ; the following instruction.
        MOV    r5,#0x5

```

Related references

[15.6 AREA on page 15-767.](#)

15.6 AREA

The AREA directive instructs the assembler to assemble a new code or data section.

Syntax

```
AREA sectionname{,attr}{,attr}...
```

where:

sectionname

is the name to give to the section. Sections are independent, named, indivisible chunks of code or data that are manipulated by the linker.

You can choose any name for your sections. However, names starting with a non-alphabetic character must be enclosed in bars or a missing section name error is generated. For example, | 1_DataArea |.

Certain names are conventional. For example, | .text | is used for code sections produced by the C compiler, or for code sections otherwise associated with the C library.

attr

are one or more comma-delimited section attributes. Valid attributes are:

ALIGN=*expression*

By default, ELF sections are aligned on a four-byte boundary. *expression* can have any integer value from 0 to 31. The section is aligned on a $2^{\textit{expression}}$ -byte boundary. For example, if *expression* is 10, the section is aligned on a 1KB boundary.

This is not the same as the way that the ALIGN directive is specified.

————— **Note** —————

Do not use ALIGN=0 or ALIGN=1 for ARM code sections.

Do not use ALIGN=0 for Thumb code sections.

ASSOC=*section*

section specifies an associated ELF section. *sectionname* must be included in any link that includes *section*

CODE

Contains machine instructions. READONLY is the default.

CODEALIGN

Causes *armasm* to insert NOP instructions when the ALIGN directive is used after ARM or Thumb instructions within the section, unless the ALIGN directive specifies a different padding. CODEALIGN is the default for execute-only sections.

COMDEF

Is a common section definition. This ELF section can contain code or data. It must be identical to any other section of the same name in other source files.

Identical ELF sections with the same name are overlaid in the same section of memory by the linker. If any are different, the linker generates a warning and does not overlay the sections.

COMGROUP=*symbol_name*

Is the signature that makes the AREA part of the named ELF section group. See the GROUP=*symbol_name* for more information. The COMGROUP attribute marks the ELF section group with the GRP_COMDAT flag.

COMMON

Is a common data section. You must not define any code or data in it. It is initialized to zeros by the linker. All common sections with the same name are overlaid in the same section of memory by the linker. They do not all have to be the same size. The linker allocates as much space as is required by the largest common section of each name.

DATA

Contains data, not instructions. READWRITE is the default.

EXECONLY

Indicates that the section is execute-only. Execute-only sections must also have the CODE attribute, and must not have any of the following attributes:

- READONLY.
- READWRITE.
- DATA.
- ZEROALIGN.

armasm faults if any of the following occur in an execute-only section:

- Explicit data definitions, for example DCD and DCB.
- Implicit data definitions, for example LDR r0, =0xaabbccdd.
- Literal pool directives, for example LTORG, if there is literal data to be emitted.
- INCBIN or SPACE directives.
- ALIGN directives, if the required alignment cannot be accomplished by padding with NOP instructions. armasm implicitly applies the CODEALIGN attribute to sections with the EXECONLY attribute.

FINI_ARRAY

Sets the ELF type of the current area to SHT_FINI_ARRAY.

GROUP=*symbol_name*

Is the signature that makes the AREA part of the named ELF section group. It must be defined by the source file, or a file included by the source file. All AREAS with the same *symbol_name* signature are part of the same group. Sections within a group are kept or discarded together.

INIT_ARRAY

Sets the ELF type of the current area to SHT_INIT_ARRAY.

LINKORDER=*section*

Specifies a relative location for the current section in the image. It ensures that the order of all the sections with the LINKORDER attribute, with respect to each other, is the same as the order of the corresponding named *sections* in the image.

MERGE=*n*

Indicates that the linker can merge the current section with other sections with the MERGE=*n* attribute. *n* is the size of the elements in the section, for example *n* is 1 for characters. You must not assume that the section is merged, because the attribute does not force the linker to merge the sections.

NOALLOC

Indicates that no memory on the target system is allocated to this area.

NOINIT

Indicates that the data section is uninitialized, or initialized to zero. It contains only space reservation directives SPACE or DCB, DCD, DCDU, DCQ, DCQU, DCW, or DCWU with initialized values of zero. You can decide at link time whether an area is uninitialized or zero-initialized.

————— **Note** —————

ARM Compiler does not support systems with ECC or parity protection where the memory is not initialized.

PREINIT_ARRAY

Sets the ELF type of the current area to SHT_PREINIT_ARRAY.

READONLY

Indicates that this section must not be written to. This is the default for Code areas.

READWRITE

Indicates that this section can be read from and written to. This is the default for Data areas.

- SECFLAGS=*n***
Adds one or more ELF flags, denoted by *n*, to the current section.
- SECTYPE=*n***
Sets the ELF type of the current section to *n*.
- STRINGS**
Adds the SHF_STRINGS flag to the current section. To use the STRINGS attribute, you must also use the MERGE=1 attribute. The contents of the section must be strings that are nul-terminated using the DCB directive.
- ZEROALIGN**
Causes *armasm* to insert zeros when the ALIGN directive is used after ARM or Thumb instructions within the section, unless the ALIGN directive specifies a different padding. ZEROALIGN is the default for sections that are not execute-only.

Usage

Use the AREA directive to subdivide your source file into ELF sections. You can use the same name in more than one AREA directive. All areas with the same name are placed in the same ELF section. Only the attributes of the first AREA directive of a particular name are applied.

In general, ARM recommends that you use separate ELF sections for code and data. However, you can put data in code sections. Large programs can usually be conveniently divided into several code sections. Large independent data sets are also usually best placed in separate sections.

The scope of numeric local labels is defined by AREA directives, optionally subdivided by ROUT directives.

There must be at least one AREA directive for an assembly.

Note

armasm emits R_ARM_TARGET1 relocations for the DCD and DCUD directives if the directive uses PC-relative expressions and is in any of the PREINIT_ARRAY, FINI_ARRAY, or INIT_ARRAY ELF sections. You can override the relocation using the RELOC directive after each DCD or DCUD directive. If this relocation is used, read-write sections might become read-only sections at link time if the platform ABI permits this.

Example

The following example defines a read-only code section named Example:

```
AREA    Example, CODE, READONLY    ; An example code section.
        ; code
```

Related concepts

[3.3 ELF sections and the AREA directive on page 3-61.](#)

Related references

[15.5 ALIGN on page 15-765.](#)

[15.57 RELOC on page 15-827.](#)

[15.16 DCD and DCUD on page 15-779.](#)

Related information

[Execute-only memory.](#)

[Building applications for execute-only memory.](#)

[Information about image structure and generation.](#)

15.7 ARM or CODE32

The ARM directive instructs the assembler to interpret subsequent instructions as ARM instructions, using either the UAL or the pre-UAL ARM assembly language syntax. CODE32 is a synonym for ARM.

Syntax

ARM

Usage

In files that contain code using different instruction sets, ARM must precede any ARM code.

If necessary, this directive also inserts up to three bytes of padding to align to the next word boundary.

This directive does not assemble to any instructions. It also does not change the state. It only instructs the assembler to assemble ARM instructions, and inserts padding if necessary.

ARM and THUMB directives

This example shows how you can use ARM and THUMB directives to switch state and assemble both ARM and Thumb instructions in a single area.

```
AREA ToThumb, CODE, READONLY ; Name this block of code
ENTRY                          ; Mark first instruction to execute
ARM                             ; Subsequent instructions are ARM
start
  ADR    r0, into_thumb + 1    ; Processor starts in ARM state
  BX     r0                    ; Inline switch to Thumb state
  THUMB                               ; Subsequent instructions are Thumb
into_thumb
  MOVS   r0, #10                ; New-style Thumb instructions
```

Related references

[15.11 CODE16 on page 15-774.](#)

[15.65 THUMB on page 15-835.](#)

[15.66 THUMBX on page 15-836.](#)

15.8 ASSERT

The ASSERT directive generates an error message during assembly if a given assertion is false.

Syntax

ASSERT *logical-expression*

where:

logical-expression

is an assertion that can evaluate to either {TRUE} or {FALSE}.

Usage

Use ASSERT to ensure that any necessary condition is met during assembly.

If the assertion is false an error message is generated and assembly fails.

Example

```
ASSERT label1 <= label2    ; Tests if the address
                           ; represented by label1
                           ; is <= the address
                           ; represented by label2.
```

Related references

[15.47 INFO](#) on page 15-813.

15.9 ATTR

The ATTR set directives set values for the ABI build attributes. The ATTR scope directives specify the scope for which the set value applies to.

Syntax

```
ATTR FILESCOPE
```

```
ATTR SCOPE name
```

```
ATTR settype tagid, value
```

where:

name

is a section name or symbol name.

settype

can be any of:

- SETVALUE.
- SETSTRING.
- SETCOMPATWITHVALUE.
- SETCOMPATWITHSTRING.

tagid

is an attribute tag name (or its numerical value) defined in the ABI for the ARM Architecture.

value

depends on *settype*:

- is a 32-bit integer value when *settype* is SETVALUE or SETCOMPATWITHVALUE.
- is a nul-terminated string when *settype* is SETSTRING or SETCOMPATWITHSTRING.

Usage

The ATTR set directives following the ATTR FILESCOPE directive apply to the entire object file. The ATTR set directives following the ATTR SCOPE *name* directive apply only to the named section or symbol.

For tags that expect an integer, you must use SETVALUE or SETCOMPATWITHVALUE. For tags that expect a string, you must use SETSTRING or SETCOMPATWITHSTRING.

Use SETCOMPATWITHVALUE and SETCOMPATWITHSTRING to set tag values which the object file is also compatible with.

Examples

```
ATTR SETSTRING Tag_CPU_raw_name, "Cortex-A8"
ATTR SETVALUE Tag_VFP_arch, 3 ; VFPv3 instructions permitted.
ATTR SETVALUE 10, 3 ; 10 is the numerical value of
; Tag_VFP_arch.
```

Related information

Addenda to, and Errata in, the ABI for the ARM Architecture.

15.10 CN

The CN directive defines a name for a coprocessor register.

Syntax

```
name CN expr
```

where:

name

is the name to be defined for the coprocessor register. *name* cannot be the same as any of the predefined names.

expr

evaluates to a coprocessor register number from 0 to 15.

Usage

Use CN to allocate convenient names to registers, to help you remember what you use each register for.

Note

Avoid conflicting uses of the same register under different names.

The names c0 to c15 are predefined.

Example

```
power    CN 6      ; defines power as a symbol for  
          ; coprocessor register 6
```

Related references

[2.11 Predeclared core register names](#) on page 2-46.

[2.12 Predeclared extension register names](#) on page 2-47.

[2.13 Predeclared XScale register names](#) on page 2-48.

15.11 CODE16

The CODE16 directive instructs the assembler to interpret subsequent instructions as Thumb instructions, using the pre-UAL assembly language syntax.

Syntax

CODE16

Usage

In files that contain code using different instruction sets, CODE16 must precede Thumb code written in pre-UAL syntax.

If necessary, this directive also inserts one byte of padding to align to the next halfword boundary.

This directive does not assemble to any instructions. It also does not change the state. It only instructs the assembler to assemble Thumb instructions, and inserts padding if necessary.

Related references

[15.7 ARM or CODE32 on page 15-770.](#)

[15.65 THUMB on page 15-835.](#)

[15.66 THUMBX on page 15-836.](#)

15.12 COMMON

The `COMMON` directive allocates a block of memory of the defined size, at the specified symbol.

Syntax

```
COMMON symbol{,size{,alignment}} {[attr]}
```

where:

symbol

is the symbol name. The symbol name is case-sensitive.

size

is the number of bytes to reserve.

alignment

is the alignment.

attr

can be any one of:

DYNAMIC

sets the ELF symbol visibility to `STV_DEFAULT`.

PROTECTED

sets the ELF symbol visibility to `STV_PROTECTED`.

HIDDEN

sets the ELF symbol visibility to `STV_HIDDEN`.

INTERNAL

sets the ELF symbol visibility to `STV_INTERNAL`.

Usage

You specify how the memory is aligned. If the alignment is omitted, the default alignment is four. If the size is omitted, the default size is zero.

You can access this memory as you would any other memory, but no space is allocated by the assembler in object files. The linker allocates the required space as zero-initialized memory during the link stage.

You cannot define, `IMPORT` or `EXTERN` a symbol that has already been created by the `COMMON` directive. In the same way, if a symbol has already been defined or used with the `IMPORT` or `EXTERN` directive, you cannot use the same symbol for the `COMMON` directive.

Correct example

```
LDR    r0, =xyz
COMMON xyz,255,4 ; defines 255 bytes of ZI store, word-aligned
```

Incorrect example

```
COMMON foo,4,4
COMMON bar,4,4
foo DCD 0 ; cannot define label with same name as COMMON
IMPORT bar ; cannot import label with same name as COMMON
```

15.13 CP

The CP directive defines a name for a specified coprocessor.

Syntax

name CP *expr*

where:

name

is the name to be assigned to the coprocessor. *name* cannot be the same as any of the predefined names.

expr

evaluates to a coprocessor number within the range 0 to 15.

Usage

Use CP to allocate convenient names to coprocessors, to help you to remember what you use each one for.

————— **Note** —————

Avoid conflicting uses of the same coprocessor under different names.

—————

The names p0 to p15 are predefined for coprocessors 0 to 15.

Example

```
dmu    CP 6    ; defines dmu as a symbol for  
        ; coprocessor 6
```

Related references

[2.11 Predeclared core register names on page 2-46.](#)

[2.12 Predeclared extension register names on page 2-47.](#)

[2.13 Predeclared XScale register names on page 2-48.](#)

15.14 DATA

The DATA directive is no longer required. It is ignored by the assembler.

15.15 DCB

The DCB directive allocates one or more bytes of memory, and defines the initial runtime contents of the memory.

Syntax

```
{label} DCB expr{,expr}...
```

where:

expr

is either:

- A numeric expression that evaluates to an integer in the range –128 to 255.
- A quoted string. The characters of the string are loaded into consecutive bytes of store.

Usage

If DCB is followed by an instruction, use an ALIGN directive to ensure that the instruction is aligned.

= is a synonym for DCB.

Example

Unlike C strings, ARM assembler strings are not nul-terminated. You can construct a nul-terminated C string using DCB as follows:

```
C_string DCB "C_string",0
```

Related concepts

[7.14 Numeric expressions](#) on page 7-151.

Related references

[15.16 DCD and DCDD](#) on page 15-779.

[15.21 DCQ and DCQU](#) on page 15-784.

[15.22 DCW and DCWU](#) on page 15-785.

[15.64 SPACE or FILL](#) on page 15-834.

[15.5 ALIGN](#) on page 15-765.

15.16 DCD and DCDU

The DCD directive allocates one or more words of memory, aligned on four-byte boundaries, and defines the initial runtime contents of the memory. DCDU is the same, except that the memory alignment is arbitrary.

Syntax

```
{label} DCD{U} expr{,expr}
```

where:

expr

is either:

- A numeric expression.
- A PC-relative expression.

Usage

DCD inserts up to three bytes of padding before the first defined word, if necessary, to achieve four-byte alignment.

Use DCDU if you do not require alignment.

& is a synonym for DCD.

Examples

```
data1 DCD 1,5,20 ; Defines 3 words containing
           ; decimal values 1, 5, and 20
data2 DCD mem06 + 4 ; Defines 1 word containing 4 +
           ; the address of the label mem06
           AREA MyData, DATA, READWRITE
           DCB 255 ; Now misaligned ...
data3 DCDU 1,5,20 ; Defines 3 words containing
           ; 1, 5 and 20, not word aligned
```

Related concepts

[7.14 Numeric expressions](#) on page 7-151.

Related references

[15.15 DCB](#) on page 15-778.

[15.21 DCQ and DCQU](#) on page 15-784.

[15.22 DCW and DCWU](#) on page 15-785.

[15.64 SPACE or FILL](#) on page 15-834.

[15.20 DCI](#) on page 15-783.

15.17 DCDO

The DCDO directive allocates one or more words of memory, aligned on four-byte boundaries, and defines the initial runtime contents of the memory as an offset from the *static base register*, sb (R9).

Syntax

```
{label} DCDO expr{,expr}...
```

where:

expr

is a register-relative expression or label. The base register must be sb.

Usage

Use DCDO to allocate space in memory for static base register relative relocatable addresses.

Example

```
IMPORT externsym  
DCDO    externsym    ; 32-bit word relocated by offset of  
                    ; externsym from base of SB section.
```

15.18 DCFD and DCFDU

The DCFD directive allocates memory for word-aligned double-precision floating-point numbers, and defines the initial runtime contents of the memory. DCFDU is the same, except that the memory alignment is arbitrary.

Syntax

```
{label} DCFD{U} fpliteral{,fpliteral}...
```

where:

fpliteral

is a double-precision floating-point literal.

Usage

Double-precision numbers occupy two words and must be word aligned to be used in arithmetic operations. The assembler inserts up to three bytes of padding before the first defined number, if necessary, to achieve four-byte alignment.

Use DCFDU if you do not require alignment.

The word order used when converting *fpliteral* to internal form is controlled by the floating-point architecture selected. You cannot use DCFD or DCFDU if you select the `--fpu none` option.

The range for double-precision numbers is:

- Maximum 1.79769313486231571e+308.
- Minimum 2.22507385850720138e-308.

Examples

```
DCFD    1E308, -4E-100
DCFDU   10000, -.1, 3.1E26
```

Related references

[15.19 DCFS and DCFSU](#) on page 15-782.

[7.16 Syntax of floating-point literals](#) on page 7-153.

15.19 DCFS and DCFSU

The DCFS directive allocates memory for word-aligned single-precision floating-point numbers, and defines the initial runtime contents of the memory. DCFSU is the same, except that the memory alignment is arbitrary.

Syntax

```
{label} DCFS{U} fpliteral{,fpliteral}...
```

where:

fpliteral

is a single-precision floating-point literal.

Usage

Single-precision numbers occupy one word and must be word aligned to be used in arithmetic operations. DCFS inserts up to three bytes of padding before the first defined number, if necessary to achieve four-byte alignment.

Use DCFSU if you do not require alignment.

The range for single-precision values is:

- Maximum 3.40282347e+38.
- Minimum 1.17549435e-38.

Examples

```
DCFS    1E3, -4E-9
DCFSU   1.0, -.1, 3.1E6
```

Related references

[15.18 DCFD and DCFDU](#) on page 15-781.

[7.16 Syntax of floating-point literals](#) on page 7-153.

15.20 DCI

The DCI directive allocates two or four-byte aligned memory and defines the initial runtime contents of the memory.

Syntax

```
{Label} DCI{.W} expr{,expr}
```

where:

expr

is a numeric expression.

.W

if present, indicates that four bytes must be inserted in Thumb code.

Usage

The DCI directive is very like the DCD or DCW directives, but the location is marked as code instead of data. Use DCI when writing macros for new instructions not supported by the version of the assembler you are using.

In ARM code, DCI allocates one or more words of memory, aligned on four-byte boundaries. It inserts up to three bytes of padding before the first defined word, if necessary, to achieve four-byte alignment.

In Thumb code, DCI allocates one or more halfwords of memory, aligned on two-byte boundaries. It inserts an initial byte of padding, if necessary, to achieve two-byte alignment.

You can use DCI to insert a bit pattern into the instruction stream. For example, use:

```
DCI 0x46c0
```

to insert the Thumb operation `MOV r8, r8`.

Example macro

```
MACRO          ; this macro translates newinstr Rd,Rm
                ; to the appropriate machine code
newinstr      $Rd,$Rm
DCI           0xe16f0f10 :OR: ($Rd:SHL:12) :OR: $Rm
MEND
```

32-bit Thumb example

```
DCI.W 0xf3af8000 ; inserts 32-bit NOP, 2-byte aligned.
```

Related concepts

[7.14 Numeric expressions on page 7-151.](#)

Related references

[15.16 DCD and DCDU on page 15-779.](#)

[15.22 DCW and DCWU on page 15-785.](#)

15.21 DCQ and DCQU

The DCQ directive allocates one or more eight-byte blocks of memory, aligned on four-byte boundaries, and defines the initial runtime contents of the memory. DCQU is the same, except that the memory alignment is arbitrary.

Syntax

```
{label} DCQ{U} {-}literal{,{-}literal...}
```

where:

literal

is a 64-bit numeric literal.

The range of numbers permitted is 0 to $2^{64}-1$.

In addition to the characters normally permitted in a numeric literal, you can prefix *literal* with a minus sign. In this case, the range of numbers permitted is -2^{63} to -1 .

The result of specifying $-n$ is the same as the result of specifying $2^{64}-n$.

Usage

DCQ inserts up to three bytes of padding before the first defined eight-byte block, if necessary, to achieve four-byte alignment.

Use DCQU if you do not require alignment.

Correct example

```
data    AREA    MiscData, DATA, READWRITE
        DCQ    -225,2_101    ; 2_101 means binary 101.
```

Incorrect example

```
number EQU    2
        DCQU   number    ; DCQ and DCQU only accept literals not
                          ; expressions.
```

Related concepts

[7.14 Numeric expressions on page 7-151.](#)

Related references

[15.15 DCB on page 15-778.](#)

[15.16 DCD and DCDU on page 15-779.](#)

[15.22 DCW and DCWU on page 15-785.](#)

[15.64 SPACE or FILL on page 15-834.](#)

15.22 DCW and DCWU

The DCW directive allocates one or more halfwords of memory, aligned on two-byte boundaries, and defines the initial runtime contents of the memory. DCWU is the same, except that the memory alignment is arbitrary.

Syntax

```
{Label} DCW{U} expr{,expr}...
```

where:

expr

is a numeric expression that evaluates to an integer in the range -32768 to 65535 .

Usage

DCW inserts a byte of padding before the first defined halfword if necessary to achieve two-byte alignment.

Use DCWU if you do not require alignment.

Examples

```
data    DCW    -225,2*number    ; number must already be defined
        DCWU   number+4
```

Related concepts

[7.14 Numeric expressions on page 7-151.](#)

Related references

[15.15 DCB on page 15-778.](#)

[15.16 DCD and DCDU on page 15-779.](#)

[15.21 DCQ and DCQU on page 15-784.](#)

[15.64 SPACE or FILL on page 15-834.](#)

15.23 END

The END directive informs the assembler that it has reached the end of a source file.

Syntax

END

Usage

Every assembly language source file must end with END on a line by itself.

If the source file has been included in a parent file by a GET directive, the assembler returns to the parent file and continues assembly at the first line following the GET directive.

If END is reached in the top-level source file during the first pass without any errors, the second pass begins.

If END is reached in the top-level source file during the second pass, the assembler finishes the assembly and writes the appropriate output.

Related references

[15.43 GET or INCLUDE on page 15-807.](#)

15.24 ENDFUNC or ENDP

The ENDFUNC directive marks the end of an AAPCS-conforming function. ENDP is a synonym for ENDFUNC.

Related references

[15.41 FUNCTION or PROC](#) on page 15-805.

15.25 ENTRY

The ENTRY directive declares an entry point to a program.

Syntax

```
ENTRY
```

Usage

A program must have an entry point. You can specify an entry point in the following ways:

- Using the ENTRY directive in assembly language source code.
- Providing a `main()` function in C or C++ source code.
- Using the `armlink --entry` command-line option.

You can declare more than one entry point in a program, although a source file cannot contain more than one ENTRY directive. For example, a program could contain multiple assembly language source files, each with an ENTRY directive. Or it could contain a C or C++ file with a `main()` function and one or more assembly source files with an ENTRY directive.

If the program contains multiple entry points, then you must select one of them. You do this by exporting the symbol for the ENTRY directive that you want to use as the entry point, then using the `armlink --entry` option to select the exported symbol.

Example

```
AREA  ARMex, CODE, READONLY
ENTRY  ; Entry point for the application.
EXPORT ep1 ; Export the symbol so the linker can find it
ep1    ; in the object file.
      ; code
      END
```

When you invoke `armlink`, if other entry points are declared in the program, then you must specify `--entry=ep1`, to select `ep1`.

Related information

[Image entry points.](#)

`--entry=location.`

15.26 EQU

The EQU directive gives a symbolic name to a numeric constant, a register-relative value or a PC-relative value.

Syntax

```
name EQU expr{, type}
```

where:

name

is the symbolic name to assign to the value.

expr

is a register-relative address, a PC-relative address, an absolute address, or a 32-bit integer constant.

type

is optional. *type* can be any one of:

- ARM.
- THUMB.
- CODE32.
- CODE16.
- DATA.

You can use *type* only if *expr* is an absolute address. If *name* is exported, the *name* entry in the symbol table in the object file is marked as ARM, THUMB, CODE32, CODE16, or DATA, according to *type*. This can be used by the linker.

Usage

Use EQU to define constants. This is similar to the use of **#define** to define a constant in C.

* is a synonym for EQU.

Examples

```

abc EQU 2           ; Assigns the value 2 to the symbol abc.
xyz EQU label+8    ; Assigns the address (label+8) to the
                  ; symbol xyz.
fiq EQU 0x1C, CODE32 ; Assigns the absolute address 0x1C to
                  ; the symbol fiq, and marks it as code.

```

Related references

[15.48 KEEP](#) on page 15-814.

[15.27 EXPORT or GLOBAL](#) on page 15-790.

15.27 EXPORT or GLOBAL

The EXPORT directive declares a symbol that can be used by the linker to resolve symbol references in separate object and library files. GLOBAL is a synonym for EXPORT.

Syntax

```
EXPORT {[WEAK]}
```

```
EXPORT symbol {[SIZE=n]}
```

```
EXPORT symbol {[type{,set}]}
```

```
EXPORT symbol [attr{,type{,set}},{,SIZE=n}]
```

```
EXPORT symbol [WEAK {,attr}{,type{,set}},{,SIZE=n}]
```

where:

symbol

is the symbol name to export. The symbol name is case-sensitive. If *symbol* is omitted, all symbols are exported.

WEAK

symbol is only imported into other sources if no other source exports an alternative *symbol*. If [WEAK] is used without *symbol*, all exported symbols are weak.

attr

can be any one of:

DYNAMIC

sets the ELF symbol visibility to STV_DEFAULT.

PROTECTED

sets the ELF symbol visibility to STV_PROTECTED.

HIDDEN

sets the ELF symbol visibility to STV_HIDDEN.

INTERNAL

sets the ELF symbol visibility to STV_INTERNAL.

type

specifies the symbol type:

DATA

symbol is treated as data when the source is assembled and linked.

CODE

symbol is treated as code when the source is assembled and linked.

ELFTYPE=*n*

symbol is treated as a particular ELF symbol, as specified by the value of *n*, where *n* can be any number from 0 to 15.

If unspecified, the assembler determines the most appropriate type. Usually the assembler determines the correct type so you are not required to specify it.

set

specifies the instruction set:

ARM

symbol is treated as an ARM symbol.

THUMB

symbol is treated as a Thumb symbol.

If unspecified, the assembler determines the most appropriate set.

n

specifies the size and can be any 32-bit value. If the SIZE attribute is not specified, the assembler calculates the size:

- For PROC and FUNCTION symbols, the size is set to the size of the code until its ENDP or ENDFUNC.
- For other symbols, the size is the size of instruction or data on the same source line. If there is no instruction or data, the size is zero.

Usage

Use EXPORT to give code in other files access to symbols in the current file.

Use the [WEAK] attribute to inform the linker that a different instance of *symbol* takes precedence over this one, if a different one is available from another source. You can use the [WEAK] attribute with any of the symbol visibility attributes.

Examples

```

AREA Example, CODE, READONLY
EXPORT DoAdd ; Export the function name
DoAdd ADD r0, r0, r1 ; to be used by external modules.

```

Symbol visibility can be overridden for duplicate exports. In the following example, the last EXPORT takes precedence for both binding and visibility:

```

EXPORT SymA[WEAK] ; Export as weak-hidden
EXPORT SymA[DYNAMIC] ; SymA becomes non-weak dynamic.

```

The following examples show the use of the SIZE attribute:

```

EXPORT symA [SIZE=4]
EXPORT symA [DATA, SIZE=4]

```

Related references

[15.45 IMPORT and EXTERN on page 15-810.](#)

Related information

[ELF for the ARM Architecture.](#)

15.28 EXPORTAS

The EXPORTAS directive enables you to export a symbol from the object file, corresponding to a different symbol in the source file.

Syntax

```
EXPORTAS symbol1, symbol2
```

where:

symbol1

is the symbol name in the source file. *symbol1* must have been defined already. It can be any symbol, including an area name, a label, or a constant.

symbol2

is the symbol name you want to appear in the object file.

The symbol names are case-sensitive.

Usage

Use EXPORTAS to change a symbol in the object file without having to change every instance in the source file.

Examples

```
AREA data1, DATA ; Starts a new area data1.
AREA data2, DATA ; Starts a new area data2.
EXPORTAS data2, data1 ; The section symbol referred to as data2
; appears in the object file string table as data1.
one EQU 2
EXPORTAS one, two ; The symbol 'two' appears in the object
EXPORT one ; file's symbol table with the value 2.
```

Related references

[15.27 EXPORT or GLOBAL](#) on page 15-790.

15.29 FIELD

The FIELD directive describes space within a storage map that has been defined using the MAP directive.

Syntax

```
{Label} FIELD expr
```

where:

Label

is an optional label. If specified, *Label* is assigned the value of the storage location counter, {VAR}. The storage location counter is then incremented by the value of *expr*.

expr

is an expression that evaluates to the number of bytes to increment the storage counter.

Usage

If a storage map is set by a MAP directive that specifies a *base-register*, the base register is implicit in all labels defined by following FIELD directives, until the next MAP directive. These register-relative labels can be quoted in load and store instructions.

is a synonym for FIELD.

Examples

The following example shows how register-relative labels are defined using the MAP and FIELD directives:

MAP	0,r9	; set {VAR} to the address stored in R9
FIELD	4	; increment {VAR} by 4 bytes
Lab	FIELD 4	; set Lab to the address [R9 + 4]
		; and then increment {VAR} by 4 bytes
LDR	r0,Lab	; equivalent to LDR r0,[r9,#4]

When using the MAP and FIELD directives, you must ensure that the values are consistent in both passes. The following example shows a use of MAP and FIELD that causes inconsistent values for the symbol x. In the first pass sym is not defined, so x is at 0x04+R9. In the second pass, sym is defined, so x is at 0x00+R0. This example results in an assembly error.

```
MAP 0, r0
if :LNOT: :DEF: sym
  MAP 0, r9
  FIELD 4 ; x is at 0x04+R9 in first pass
ENDIF
x FIELD 4 ; x is at 0x00+R0 in second pass
sym LDR r0, x ; inconsistent values for x results in assembly error
```

Related concepts

[1.3 How the assembler works on page 1-30.](#)

Related references

[15.52 MAP on page 15-820.](#)

[1.4 Directives that can be omitted in pass 2 of the assembler on page 1-32.](#)

15.30 FRAME ADDRESS

The `FRAME ADDRESS` directive describes how to calculate the canonical frame address for the following instructions.

Syntax

```
FRAME ADDRESS reg{,offset}
```

where:

reg

is the register on which the canonical frame address is to be based. This is SP unless the function uses a separate frame pointer.

offset

is the offset of the canonical frame address from *reg*. If *offset* is zero, you can omit it.

Usage

Use `FRAME ADDRESS` if your code alters which register the canonical frame address is based on, or if it changes the offset of the canonical frame address from the register. You must use `FRAME ADDRESS` immediately after the instruction that changes the calculation of the canonical frame address.

You can only use `FRAME ADDRESS` in functions with `FUNCTION` and `ENDFUNC` or `PROC` and `ENDP` directives.

Note

If your code uses a single instruction to save registers and alter the stack pointer, you can use `FRAME PUSH` instead of using both `FRAME ADDRESS` and `FRAME SAVE`.

If your code uses a single instruction to load registers and alter the stack pointer, you can use `FRAME POP` instead of using both `FRAME ADDRESS` and `FRAME RESTORE`.

Example

```

_fn    FUNCTION           ; CFA (Canonical Frame Address) is value
        ; of SP on entry to function
        PUSH    {r4,fp,ip,lr,pc}
        FRAME PUSH {r4,fp,ip,lr,pc}
        SUB     sp,sp,#4    ; CFA offset now changed
        FRAME ADDRESS sp,24 ; - so we correct it
        ADD     fp,sp,#20
        FRAME ADDRESS fp,4 ; New base register
        ; code using fp to base call-frame on, instead of SP

```

Related references

[15.31 FRAME POP on page 15-795.](#)

[15.32 FRAME PUSH on page 15-796.](#)

15.31 FRAME POP

The `FRAME POP` directive informs the assembler when the callee reloads registers.

Syntax

There are the following alternative syntaxes for `FRAME POP`:

```
FRAME POP {regList}
```

```
FRAME POP {regList},n
```

```
FRAME POP n
```

where:

regList

is a list of registers restored to the values they had on entry to the function. There must be at least one register in the list.

n

is the number of bytes that the stack pointer moves.

Usage

`FRAME POP` is equivalent to a `FRAME ADDRESS` and a `FRAME RESTORE` directive. You can use it when a single instruction loads registers and alters the stack pointer.

You must use `FRAME POP` immediately after the instruction it refers to.

You can only use it within functions with `FUNCTION` and `ENDFUNC` or `PROC` and `ENDP` directives. You do not have to do this after the last instruction in a function.

If *n* is not specified or is zero, the assembler calculates the new offset for the canonical frame address from *{regList}*. It assumes that:

- Each ARM register popped occupies four bytes on the stack.
- Each VFP single-precision register popped occupies four bytes on the stack, plus an extra four-byte word for each list.
- Each VFP double-precision register popped occupies eight bytes on the stack, plus an extra four-byte word for each list.

Related references

[15.30 FRAME ADDRESS](#) on page 15-794.

[15.34 FRAME RESTORE](#) on page 15-798.

15.32 FRAME PUSH

The `FRAME PUSH` directive informs the assembler when the callee saves registers, normally at function entry.

Syntax

There are the following alternative syntaxes for `FRAME PUSH`:

```
FRAME PUSH {regList}
```

```
FRAME PUSH {regList},n
```

```
FRAME PUSH n
```

where:

regList

is a list of registers stored consecutively below the canonical frame address. There must be at least one register in the list.

n

is the number of bytes that the stack pointer moves.

Usage

`FRAME PUSH` is equivalent to a `FRAME ADDRESS` and a `FRAME SAVE` directive. You can use it when a single instruction saves registers and alters the stack pointer.

You must use `FRAME PUSH` immediately after the instruction it refers to.

You can only use it within functions with `FUNCTION` and `ENDFUNC` or `PROC` and `ENDP` directives.

If *n* is not specified or is zero, the assembler calculates the new offset for the canonical frame address from *{regList}*. It assumes that:

- Each ARM register pushed occupies four bytes on the stack.
- Each VFP single-precision register pushed occupies four bytes on the stack, plus an extra four-byte word for each list.
- Each VFP double-precision register popped occupies eight bytes on the stack, plus an extra four-byte word for each list.

Example

```
p PROC ; Canonical frame address is SP + 0
EXPORT p
PUSH {r4-r6,lr}
; SP has moved relative to the canonical frame address,
; and registers R4, R5, R6 and LR are now on the stack
FRAME PUSH {r4-r6,lr}
; Equivalent to:
; FRAME ADDRESS sp,16 ; 16 bytes in {R4-R6,LR}
; FRAME SAVE {r4-r6,lr},-16
```

Related references

[15.30 FRAME ADDRESS](#) on page 15-794.

[15.36 FRAME SAVE](#) on page 15-800.

15.33 FRAME REGISTER

The `FRAME REGISTER` directive maintains a record of the locations of function arguments held in registers.

Syntax

```
FRAME REGISTER reg1, reg2
```

where:

reg1

is the register that held the argument on entry to the function.

reg2

is the register in which the value is preserved.

Usage

Use the `FRAME REGISTER` directive when you use a register to preserve an argument that was held in a different register on entry to a function.

You can only use it within functions with `FUNCTION` and `ENDFUNC` or `PROC` and `ENDP` directives.

15.34 FRAME RESTORE

The `FRAME RESTORE` directive informs the assembler that the contents of specified registers have been restored to the values they had on entry to the function.

Syntax

```
FRAME RESTORE {reglist}
```

where:

reglist

is a list of registers whose contents have been restored. There must be at least one register in the list.

Usage

You can only use `FRAME RESTORE` within functions with `FUNCTION` and `ENDFUNC` or `PROC` and `ENDP` directives. Use it immediately after the callee reloads registers from the stack. You do not have to do this after the last instruction in a function.

reglist can contain integer registers or floating-point registers, but not both.

Note

If your code uses a single instruction to load registers and alter the stack pointer, you can use `FRAME POP` instead of using both `FRAME RESTORE` and `FRAME ADDRESS`.

Related references

[15.31 FRAME POP on page 15-795.](#)

15.35 FRAME RETURN ADDRESS

The `FRAME RETURN ADDRESS` directive provides for functions that use a register other than LR for their return address.

Syntax

```
FRAME RETURN ADDRESS reg
```

where:

reg

is the register used for the return address.

Usage

Use the `FRAME RETURN ADDRESS` directive in any function that does not use LR for its return address. Otherwise, a debugger cannot backtrace through the function.

You can only use `FRAME RETURN ADDRESS` within functions with `FUNCTION` and `ENDFUNC` or `PROC` and `ENDP` directives. Use it immediately after the `FUNCTION` or `PROC` directive that introduces the function.

Note

Any function that uses a register other than LR for its return address is not AAPCS compliant. Such a function must not be exported.

15.36 FRAME SAVE

The `FRAME SAVE` directive describes the location of saved register contents relative to the canonical frame address.

Syntax

```
FRAME SAVE {reglist}, offset
```

where:

reglist

is a list of registers stored consecutively starting at *offset* from the canonical frame address. There must be at least one register in the list.

Usage

You can only use `FRAME SAVE` within functions with `FUNCTION` and `ENDFUNC` or `PROC` and `ENDP` directives.

Use it immediately after the callee stores registers onto the stack.

reglist can include registers which are not required for backtracing. The assembler determines which registers it requires to record in the DWARF call frame information.

Note

If your code uses a single instruction to save registers and alter the stack pointer, you can use `FRAME PUSH` instead of using both `FRAME SAVE` and `FRAME ADDRESS`.

Related references

[15.32 FRAME PUSH](#) on page 15-796.

15.37 FRAME STATE REMEMBER

The `FRAME STATE REMEMBER` directive saves the current information on how to calculate the canonical frame address and locations of saved register values.

Syntax

```
FRAME STATE REMEMBER
```

Usage

During an inline exit sequence the information about calculation of canonical frame address and locations of saved register values can change. After the exit sequence another branch can continue using the same information as before. Use `FRAME STATE REMEMBER` to preserve this information, and `FRAME STATE RESTORE` to restore it.

These directives can be nested. Each `FRAME STATE RESTORE` directive must have a corresponding `FRAME STATE REMEMBER` directive.

You can only use `FRAME STATE REMEMBER` within functions with `FUNCTION` and `ENDFUNC` or `PROC` and `ENDP` directives.

Example

```
    ; function code
    FRAME STATE REMEMBER
    ; save frame state before in-line exit sequence
    POP    {r4-r6,pc}
    ; do not have to FRAME POP here, as control has
    ; transferred out of the function
    FRAME STATE RESTORE
    ; end of exit sequence, so restore state
exitB  ; code for exitB
    POP    {r4-r6,pc}
    ENDP
```

Related references

[15.38 FRAME STATE RESTORE](#) on page 15-802.

[15.41 FUNCTION or PROC](#) on page 15-805.

15.38 FRAME STATE RESTORE

The `FRAME STATE RESTORE` directive restores information about how to calculate the canonical frame address and locations of saved register values.

Syntax

```
FRAME STATE RESTORE
```

Usage

You can only use `FRAME STATE RESTORE` within functions with `FUNCTION` and `ENDFUNC` or `PROC` and `ENDP` directives.

Related references

[15.37 FRAME STATE REMEMBER](#) on page 15-801.

[15.41 FUNCTION or PROC](#) on page 15-805.

15.39 FRAME UNWIND ON

The FRAME UNWIND ON directive instructs the assembler to produce unwind tables for this and subsequent functions.

Syntax

```
FRAME UNWIND ON
```

Usage

You can use this directive outside functions. In this case, the assembler produces unwind tables for all following functions until it reaches a FRAME UNWIND OFF directive.

Note

A FRAME UNWIND directive is not sufficient to turn on exception table generation. Furthermore a FRAME UNWIND directive, without other FRAME directives, is not sufficient information for the assembler to generate the unwind information.

Related references

[10.30 --exceptions, --no_exceptions](#) on page 10-255.

[10.31 --exceptions_unwind, --no_exceptions_unwind](#) on page 10-256.

15.40 FRAME UNWIND OFF

The `FRAME UNWIND OFF` directive instructs the assembler to produce no unwind tables for this and subsequent functions.

Syntax

```
FRAME UNWIND OFF
```

Usage

You can use this directive outside functions. In this case, the assembler produces no unwind tables for all following functions until it reaches a `FRAME UNWIND ON` directive.

Related references

[10.30 `--exceptions`, `--no_exceptions` on page 10-255.](#)

[10.31 `--exceptions_unwind`, `--no_exceptions_unwind` on page 10-256.](#)

15.41 FUNCTION or PROC

The FUNCTION directive marks the start of a function. PROC is a synonym for FUNCTION.

Syntax

```
Label FUNCTION [{reglist1} [, {reglist2}]]
```

where:

reglist1

is an optional list of callee-saved ARM registers. If *reglist1* is not present, and your debugger checks register usage, it assumes that the AAPCS is in use. If you use empty brackets, this informs the debugger that all ARM registers are caller-saved.

reglist2

is an optional list of callee-saved VFP registers. If you use empty brackets, this informs the debugger that all VFP registers are caller-saved.

Usage

Use FUNCTION to mark the start of functions. The assembler uses FUNCTION to identify the start of a function when producing DWARF call frame information for ELF.

FUNCTION sets the canonical frame address to be R13 (SP), and the frame state stack to be empty.

Each FUNCTION directive must have a matching ENDFUNC directive. You must not nest FUNCTION and ENDFUNC pairs, and they must not contain PROC or ENDP directives.

You can use the optional *reglist* parameters to inform the debugger about an alternative procedure call standard, if you are using your own. Not all debuggers support this feature. See your debugger documentation for details.

If you specify an empty *reglist*, using {}, this indicates that all registers for the function are caller-saved. Typically you do this when writing a reset vector where the values in all registers are unknown on execution. This avoids problems in a debugger if it tries to construct a backtrace from the values in the registers.

Note

FUNCTION does not automatically cause alignment to a word boundary (or halfword boundary for Thumb). Use ALIGN if necessary to ensure alignment, otherwise the call frame might not point to the start of the function.

Examples

```

dadd    ALIGN          ; Ensures alignment.
        FUNCTION      ; Without the ALIGN directive this might not be word-aligned.
        EXPORT dadd
        PUSH {r4-r6,lr} ; This line automatically word-aligned.
        FRAME PUSH {r4-r6,lr}
        ; subroutine body
        POP {r4-r6,pc}
        ENDFUNC
func6   PROC {r4-r8,r12},{D1-D3} ; Non-AAPCS-conforming function.
        ...
        ENDP
func7   FUNCTION {} ; Another non-AAPCS-conforming function.
        ...
        ENDFUNC

```

Related references

[15.38 FRAME STATE RESTORE](#) on page 15-802.

[15.30 FRAME ADDRESS](#) on page 15-794.

[15.5 ALIGN](#) on page 15-765.

15.42 GBLA, GBLL, and GBLS

The GBLA, GBLL, and GBLS directives declare and initialize global variables.

Syntax

gblx variable

where:

gblx

is one of GBLA, GBLL, or GBLS.

variable

is the name of the variable. *variable* must be unique among symbols within a source file.

Usage

The GBLA directive declares a global arithmetic variable, and initializes its value to 0.

The GBLL directive declares a global logical variable, and initializes its value to {FALSE}.

The GBLS directive declares a global string variable and initializes its value to a null string, "".

Using one of these directives for a variable that is already defined re-initializes the variable.

The scope of the variable is limited to the source file that contains it.

Set the value of the variable with a SETA, SETL, or SETS directive.

Global variables can also be set with the --predefine assembler command-line option.

Examples

The following example declares a variable `objectsize`, sets the value of `objectsize` to `0xFF`, and then uses it later in a `SPACE` directive:

```

objectsize  GBLA   objectsize  ; declare the variable name
            SETA   0xFF        ; set its value
            .
            .                ; other code
            .
            SPACE objectsize  ; quote the variable

```

The following example shows how to declare and set a variable when you invoke `armasm`. Use this when you want to set the value of a variable at assembly time. `--pd` is a synonym for `--predefine`.

```

armasm --predefine "objectsize SETA 0xFF" sourcefile -o objectfile

```

Related references

[15.49 LCLA, LCLL, and LCLS](#) on page 15-815.

[15.63 SETA, SETL, and SETS](#) on page 15-833.

[10.56 --predefine "directive"](#) on page 10-282.

15.43 GET or INCLUDE

The GET directive includes a file within the file being assembled. The included file is assembled at the location of the GET directive. INCLUDE is a synonym for GET.

Syntax

```
GET filename
```

where:

filename

is the name of the file to be included in the assembly. The assembler accepts pathnames in either UNIX or MS-DOS format.

Usage

GET is useful for including macro definitions, EQUs, and storage maps in an assembly. When assembly of the included file is complete, assembly continues at the line following the GET directive.

By default the assembler searches the current place for included files. The current place is the directory where the calling file is located. Use the `-i` assembler command line option to add directories to the search path. File names and directory names containing spaces must not be enclosed in double quotes (" ").

The included file can contain additional GET directives to include other files.

If the included file is in a different directory from the current place, this becomes the current place until the end of the included file. The previous current place is then restored.

You cannot use GET to include object files.

Examples

```
AREA Example, CODE, READONLY
GET file1.s ; includes file1 if it exists in the current place
GET c:\project\file2.s ; includes file2
GET c:\Program files\file3.s ; space is permitted
```

Related references

[15.46 INCBIN on page 15-812.](#)

[15.2 About assembly control directives on page 15-762.](#)

15.44 IF, ELSE, ENDIF, and ELIF

The IF, ELSE, ENDIF, and ELIF directives allow you to conditionally assemble sequences of instructions and directives.

Syntax

```

IF Logical-expression
    ...;code
{ELSE
    ...;code}
ENDIF

```

where:

Logical-expression

is an expression that evaluates to either {TRUE} or {FALSE}.

Usage

Use IF with ENDIF, and optionally with ELSE, for sequences of instructions or directives that are only to be assembled or acted on under a specified condition.

IF...ENDIF conditions can be nested.

The IF directive introduces a condition that controls whether to assemble a sequence of instructions and directives. [is a synonym for IF.

The ELSE directive marks the beginning of a sequence of instructions or directives that you want to be assembled if the preceding condition fails. | is a synonym for ELSE.

The ENDIF directive marks the end of a sequence of instructions or directives that you want to be conditionally assembled.] is a synonym for ENDIF.

The ELIF directive creates a structure equivalent to ELSE IF, without the requirement for nesting or repeating the condition.

Using ELIF

Without using ELIF, you can construct a nested set of conditional instructions like this:

```

IF Logical-expression
    instructions
ELSE
    IF Logical-expression2
        instructions
    ELSE
        IF Logical-expression3
            instructions
        ENDIF
    ENDIF
ENDIF

```

A nested structure like this can be nested up to 256 levels deep.

You can write the same structure more simply using ELIF:

```

IF Logical-expression
    instructions
ELIF logical-expression2
    instructions
ELIF logical-expression3
    instructions
ENDIF

```

This structure only adds one to the current nesting depth, for the IF...ENDIF pair.

Examples

The following example assembles the first set of instructions if NEWVERSION is defined, or the alternative set otherwise:

Assembly conditional on a variable being defined

```

IF :DEF:NEWVERSION
    ; first set of instructions or directives
ELSE
    ; alternative set of instructions or directives
ENDIF

```

Invoking `armasm` as follows defines `NEWVERSION`, so the first set of instructions and directives are assembled:

```
armasm --predefine "NEWVERSION SETL {TRUE}" test.s
```

Invoking `armasm` as follows leaves `NEWVERSION` undefined, so the second set of instructions and directives are assembled:

```
armasm test.s
```

The following example assembles the first set of instructions if `NEWVERSION` has the value `{TRUE}`, or the alternative set otherwise:

Assembly conditional on a variable value

```

IF NEWVERSION = {TRUE}
    ; first set of instructions or directives
ELSE
    ; alternative set of instructions or directives
ENDIF

```

Invoking `armasm` as follows causes the first set of instructions and directives to be assembled:

```
armasm --predefine "NEWVERSION SETL {TRUE}" test.s
```

Invoking `armasm` as follows causes the second set of instructions and directives to be assembled:

```
armasm --predefine "NEWVERSION SETL {FALSE}" test.s
```

Related references

[7.25 Relational operators on page 7-162.](#)

[15.2 About assembly control directives on page 15-762.](#)

15.45 IMPORT and EXTERN

The IMPORT and EXTERN directives provide the assembler with a name that is not defined in the current assembly.

Syntax

directive symbol {[SIZE=*n*]}

directive symbol {[*type*]}

directive symbol [*attr*{,*type*}{,*SIZE*=*n*]}

directive symbol [WEAK {,*attr*}{,*type*}{,*SIZE*=*n*}]

where:

directive

can be either:

IMPORT

imports the symbol unconditionally.

EXTERN

imports the symbol only if it is referred to in the current assembly.

symbol

is a symbol name defined in a separately assembled source file, object file, or library. The symbol name is case-sensitive.

WEAK

prevents the linker generating an error message if the symbol is not defined elsewhere. It also prevents the linker searching libraries that are not already included.

attr

can be any one of:

DYNAMIC

sets the ELF symbol visibility to STV_DEFAULT.

PROTECTED

sets the ELF symbol visibility to STV_PROTECTED.

HIDDEN

sets the ELF symbol visibility to STV_HIDDEN.

INTERNAL

sets the ELF symbol visibility to STV_INTERNAL.

type

specifies the symbol type:

DATA

symbol is treated as data when the source is assembled and linked.

CODE

symbol is treated as code when the source is assembled and linked.

ELFTYPE=*n*

symbol is treated as a particular ELF symbol, as specified by the value of *n*, where *n* can be any number from 0 to 15.

If unspecified, the linker determines the most appropriate type.

n

specifies the size and can be any 32-bit value. If the SIZE attribute is not specified, the assembler calculates the size:

- For PROC and FUNCTION symbols, the size is set to the size of the code until its ENDP or ENDFUNC.
- For other symbols, the size is the size of instruction or data on the same source line. If there is no instruction or data, the size is zero.

Usage

The name is resolved at link time to a symbol defined in a separate object file. The symbol is treated as a program address. If [WEAK] is not specified, the linker generates an error if no corresponding symbol is found at link time.

If [WEAK] is specified and no corresponding symbol is found at link time:

- If the reference is the destination of a B or BL instruction, the value of the symbol is taken as the address of the following instruction. This makes the B or BL instruction effectively a NOP.
- Otherwise, the value of the symbol is taken as zero.

Example

The example tests to see if the C++ library has been linked, and branches conditionally on the result.

```

AREA    Example, CODE, READONLY
EXTERN  __CPP_INITIALIZE[WEAK] ; If C++ library linked, gets the
                                ; address of __CPP_INITIALIZE
                                ; function.
LDR     r0,=__CPP_INITIALIZE   ; If not linked, address is zeroed.
CMP     r0,#0                  ; Test if zero.
BEQ     nocplusplus           ; Branch on the result.

```

The following examples show the use of the SIZE attribute:

```

EXTERN symA [SIZE=4]
EXTERN symA [DATA, SIZE=4]

```

Related references

[15.27 EXPORT or GLOBAL on page 15-790.](#)

Related information

[ELF for the ARM Architecture.](#)

15.46 INCBIN

The INCBIN directive includes a file within the file being assembled. The file is included as it is, without being assembled.

Syntax

```
INCBIN filename
```

where:

filename

is the name of the file to be included in the assembly. The assembler accepts pathnames in either UNIX or MS-DOS format.

Usage

You can use INCBIN to include executable files, literals, or any arbitrary data. The contents of the file are added to the current ELF section, byte for byte, without being interpreted in any way. Assembly continues at the line following the INCBIN directive.

By default, the assembler searches the current place for included files. The current place is the directory where the calling file is located. Use the `-i` assembler command-line option to add directories to the search path. File names and directory names containing spaces must not be enclosed in double quotes (" ").

Example

```
AREA Example, CODE, READONLY
INCBIN file1.dat ; Includes file1 if it exists in the current place
INCBIN c:\project\file2.txt ; Includes file2.
```

15.47 INFO

The INFO directive supports diagnostic generation on either pass of the assembly.

Syntax

INFO *numeric-expression*, *string-expression*{, *severity*}

where:

numeric-expression

is a numeric expression that is evaluated during assembly. If the expression evaluates to zero:

- No action is taken during pass one.
- *string-expression* is printed as a warning during pass two if *severity* is 1.
- *string-expression* is printed as a message during pass two if *severity* is 0 or not specified.

If the expression does not evaluate to zero:

- *string-expression* is printed as an error message and the assembly fails irrespective of whether *severity* is specified or not (non-zero values for *severity* are reserved in this case).

string-expression

is an expression that evaluates to a string.

severity

is an optional number that controls the severity of the message. Its value can be either 0 or 1. All other values are reserved.

Usage

INFO provides a flexible means of creating custom error messages.

! is very similar to INFO, but has less detailed reporting.

Examples

```
INFO    0, "Version 1.0"  
IF endofdata <= label1  
    INFO    4, "Data overrun at label1"  
ENDIF
```

Related concepts

[7.12 String expressions](#) on page 7-149.

[7.14 Numeric expressions](#) on page 7-151.

Related references

[15.8 ASSERT](#) on page 15-771.

15.48 KEEP

The KEEP directive instructs the assembler to retain named local labels in the symbol table in the object file.

Syntax

```
KEEP {Label}
```

where:

Label

is the name of the local label to keep. If *Label* is not specified, all named local labels are kept except register-relative labels.

Usage

By default, the only labels that the assembler describes in its output object file are:

- Exported labels.
- Labels that are relocated against.

Use KEEP to preserve local labels. This can help when debugging. Kept labels appear in the ARM debuggers and in linker map files.

KEEP cannot preserve register-relative labels or numeric local labels.

Example

```
label  ADC    r2,r3,r4
        KEEP  label    ; makes label available to debuggers
        ADD   r2,r2,r5
```

Related concepts

[7.10 Numeric local labels on page 7-147.](#)

Related references

[15.52 MAP on page 15-820.](#)

15.49 LCLA, LCLL, and LCLS

The LCLA, LCLL, and LCLS directives declare and initialize local variables.

Syntax

LcLx variable

where:

LcLx

is one of LCLA, LCLL, or LCLS.

variable

is the name of the variable. *variable* must be unique within the macro that contains it.

Usage

The LCLA directive declares a local arithmetic variable, and initializes its value to 0.

The LCLL directive declares a local logical variable, and initializes its value to {FALSE}.

The LCLS directive declares a local string variable, and initializes its value to a null string, "".

Using one of these directives for a variable that is already defined re-initializes the variable.

The scope of the variable is limited to a particular instantiation of the macro that contains it.

Set the value of the variable with a SETA, SETL, or SETS directive.

Example

```

$label MACRO                                ; Declare a macro
message $a                                  ; Macro prototype line
LCLS err                                     ; Declare local string
                                             ; variable err.
err SETS "error no: "                       ; Set value of err
$label ; code
INFO 0, "err":CC::STR:$a                   ; Use string
MEND

```

Related references

[15.42 GBLA, GBLL, and GBLS](#) on page 15-806.

[15.63 SETA, SETL, and SETS](#) on page 15-833.

[15.51 MACRO and MEND](#) on page 15-817.

15.50 LTORG

The LTORG directive instructs the assembler to assemble the current literal pool immediately.

Syntax

LTORG

Usage

The assembler assembles the current literal pool at the end of every code section. The end of a code section is determined by the AREA directive at the beginning of the following section, or the end of the assembly.

These default literal pools can sometimes be out of range of some LDR, VLDR, and WLDR pseudo-instructions. Use LTORG to ensure that a literal pool is assembled within range.

Large programs can require several literal pools. Place LTORG directives after unconditional branches or subroutine return instructions so that the processor does not attempt to execute the constants as instructions.

The assembler word-aligns data in literal pools.

Example

```

start AREA Example, CODE, READONLY
func1  BL      func1
      ; code
      LDR     r1,=0x55555555 ; => LDR R1, [pc, #offset to Literal Pool 1]
      ; code
      MOV     pc,lr          ; end function
      LTORG
data   SPACE  4200          ; Literal Pool 1 contains literal &55555555.
      END                ; Clears 4200 bytes of memory starting at current location.
                        ; Default literal pool is empty.

```

Related references

[11.46 LDR pseudo-instruction on page 11-386.](#)

[13.14 VLDR pseudo-instruction on page 13-728.](#)

[12.46 VLDR pseudo-instruction on page 12-625.](#)

15.51 MACRO and MEND

The MACRO directive marks the start of the definition of a macro. Macro expansion terminates at the MEND directive.

Syntax

These two directives define a macro. The syntax is:

```

MACRO
{$Label} macroname{$cond} {$parameter{,$Label}...}
; code
MEND

```

where:

\$Label

is a parameter that is substituted with a symbol given when the macro is invoked. The symbol is usually a label.

macroname

is the name of the macro. It must not begin with an instruction or directive name.

\$cond

is a special parameter designed to contain a condition code. Values other than valid condition codes are permitted.

\$parameter

is a parameter that is substituted when the macro is invoked. A default value for a parameter can be set using this format:

```
$parameter="default value"
```

Double quotes must be used if there are any spaces within, or at either end of, the default value.

Usage

If you start any WHILE...WEND loops or IF...ENDIF conditions within a macro, they must be closed before the MEND directive is reached. You can use MEXIT to enable an early exit from a macro, for example, from within a loop.

Within the macro body, parameters such as *\$Label*, *\$parameter* or *\$cond* can be used in the same way as other variables. They are given new values each time the macro is invoked. Parameters must begin with \$ to distinguish them from ordinary symbols. Any number of parameters can be used.

\$Label is optional. It is useful if the macro defines internal labels. It is treated as a parameter to the macro. It does not necessarily represent the first instruction in the macro expansion. The macro defines the locations of any labels.

Use | as the argument to use the default value of a parameter. An empty string is used if the argument is omitted.

In a macro that uses several internal labels, it is useful to define each internal label as the base label with a different suffix.

Use a dot between a parameter and following text, or a following parameter, if a space is not required in the expansion. Do not use a dot between preceding text and a parameter.

You can use the *\$cond* parameter for condition codes. Use the unary operator :REVERSE_CC: to find the inverse condition code, and :CC_ENCODING: to find the 4-bit encoding of the condition code.

Macros define the scope of local variables.

Macros can be nested.

Examples

A macro that uses internal labels to implement loops:

```

; macro definition
MACRO                                ; start macro definition
$label      xmac      $p1,$p2
; code
$label.loop1 ; code
; code
; code
BGE      $label.loop1
$label.loop2 ; code
BL      $p1
BGT      $label.loop2
; code
ADR      $p2
; code
MEND                                ; end macro definition
; macro invocation
abc      xmac      subr1,de          ; invoke macro
; code                                  ; this is what is
abcloop1 ; code                      ; is produced when
; code                                  ; the xmac macro is
BGE      abcloop1                    ; expanded
$label.loop2 ; code
BL      subr1
BGT      abcloop2
; code
ADR      de
; code

```

A macro that produces assembly-time diagnostics:

```

MACRO                                ; Macro definition
diagnose  $param1="default"          ; This macro produces
INFO      0,"$param1"                ; assembly-time diagnostics
MEND                                ; (on second assembly pass)
; macro expansion
diagnose                                ; Prints blank line at assembly-time
diagnose "hello"                        ; Prints "hello" at assembly-time
diagnose |                              ; Prints "default" at assembly-time

```

When variables are being passed in as arguments, use of | might leave some variables unsubstituted. To work around this, define the | in a LCLS or GBLs variable and pass this variable as an argument instead of |. For example:

```

MACRO                                ; Macro definition
m2 $a,$b=r1,$c                        ; The default value for $b is r1
add $a,$b,$c                          ; The macro adds $b and $c and puts result in $a.
MEND                                    ; Macro end
MACRO                                ; Macro definition
m1 $a,$b                              ; This macro adds $b to r1 and puts result in $a.
LCLS def                               ; Declare a local string variable for |
def SETS "|"                           ; Define |
m2 $a,$def,$b                          ; Invoke macro m2 with $def instead of |
; to use the default value for the second argument.
MEND                                    ; Macro end

```

A macro that uses a condition code parameter:

```

AREA      codx, CODE, READONLY
; macro  definition
MACRO
Return$cond
[ {ARCHITECTURE} <> "4"
  BX$cond lr
  |
  MOV$cond pc,lr
]
MEND
; macro  invocation
fun      PROC
        CMP      r0,#0
        MOVEQ    r0,#1
        ReturnEQ
        MOV      r0,#0
        Return
        ENDP
        END

```

Related concepts

4.21 Use of macros on page 4-90.

7.4 Assembly time substitution of variables on page 7-141.

Related references

15.53 MEXIT on page 15-821.

15.42 GBLA, GBL, and GBL on page 15-806.

15.49 LCLA, LCLL, and LCLS on page 15-815.

15.52 MAP

The MAP directive sets the origin of a storage map to a specified address.

Syntax

```
MAP expr{,base-register}
```

where:

expr

is a numeric or PC-relative expression:

- If *base-register* is not specified, *expr* evaluates to the address where the storage map starts. The storage map location counter is set to this address.
- If *expr* is PC-relative, you must have defined the label before you use it in the map. The map requires the definition of the label during the first pass of the assembler.

base-register

specifies a register. If *base-register* is specified, the address where the storage map starts is the sum of *expr*, and the value in *base-register* at runtime.

Usage

Use the MAP directive in combination with the FIELD directive to describe a storage map.

Specify *base-register* to define register-relative labels. The base register becomes implicit in all labels defined by following FIELD directives, until the next MAP directive. The register-relative labels can be used in load and store instructions.

The MAP directive can be used any number of times to define multiple storage maps.

The storage-map location counter, {VAR}, is set to the same address as that specified by the MAP directive. The {VAR} counter is set to zero before the first MAP directive is used.

^ is a synonym for MAP.

Examples

```
MAP    0,r9
MAP    0xff,r9
```

Related concepts

[1.3 How the assembler works on page 1-30.](#)

Related references

[15.29 FIELD on page 15-793.](#)

[1.4 Directives that can be omitted in pass 2 of the assembler on page 1-32.](#)

15.53 MEXIT

The MEXIT directive exits a macro definition before the end.

Usage

Use MEXIT when you require an exit from within the body of a macro. Any unclosed WHILE . . . WEND loops or IF . . . ENDIF conditions within the body of the macro are closed by the assembler before the macro is exited.

Example

```
$abc    MACRO
        example abc    $param1,$param2
        ; code
        WHILE condition1
            ; code
            IF condition2
                ; code
                MEXIT
            ELSE
                ; code
            ENDIF
        WEND
        ; code
    MEND
```

Related references

[15.51 MACRO and MEND](#) on page 15-817.

15.54 NOFP

The NOFP directive ensures that there are no floating-point instructions in an assembly language source file.

Syntax

NOFP

Usage

Use NOFP to ensure that no floating-point instructions are used in situations where there is no support for floating-point instructions either in software or in target hardware.

If a floating-point instruction occurs after the NOFP directive, an Unknown opcode error is generated and the assembly fails.

If a NOFP directive occurs after a floating-point instruction, the assembler generates the error:

```
Too late to ban floating point instructions
```

and the assembly fails.

15.55 OPT

The OPT directive sets listing options from within the source code.

Syntax

OPT *n*

where:

n

is the OPT directive setting. The following table lists the valid settings:

Table 15-2 OPT directive settings

OPT <i>n</i>	Effect
1	Turns on normal listing.
2	Turns off normal listing.
4	Page throw. Issues an immediate form feed and starts a new page.
8	Resets the line number counter to zero.
16	Turns on listing for SET, GBL and LCL directives.
32	Turns off listing for SET, GBL and LCL directives.
64	Turns on listing of macro expansions.
128	Turns off listing of macro expansions.
256	Turns on listing of macro invocations.
512	Turns off listing of macro invocations.
1024	Turns on the first pass listing.
2048	Turns off the first pass listing.
4096	Turns on listing of conditional directives.
8192	Turns off listing of conditional directives.
16384	Turns on listing of MEND directives.
32768	Turns off listing of MEND directives.

Usage

Specify the `--list=` assembler option to turn on listing.

By default the `--list=` option produces a normal listing that includes variable declarations, macro expansions, call-conditioned directives, and MEND directives. The listing is produced on the second pass only. Use the OPT directive to modify the default listing options from within your code.

You can use OPT to format code listings. For example, you can specify a new page before functions and sections.

Example

```

start  AREA    Example, CODE, READONLY
        ; code
        ; code
        BL     func1
        ; code
        OPT 4           ; places a page break before func1
func1  ; code

```

Related references

[10.42 --list=file](#) on page 10-268.

15.56 QN, DN, and SN

The QN, DN, and SN directives define names for NEON and VFP registers.

Syntax

```
name directive expr{.type}{[x]}
```

where:

directive

is QN, DN, or SN.

name

is the name to be assigned to the extension register. *name* cannot be the same as any of the predefined names.

expr

Can be:

- An expression that evaluates to a number in the range:
 - 0-15 if you are using DN in VFPv2 or QN in NEON.
 - 0-31 otherwise.
- A predefined register name, or a register name that has already been defined in a previous directive.

type

is any NEON or VFP datatype.

[*x*]

is only available for NEON code. [*x*] is a scalar index into a register.

type and [*x*] are *Extended notation*.

Usage

Use QN, DN, or SN to allocate convenient names to extension registers, to help you to remember what you use each one for.

The QN directive defines a name for a specified 128-bit extension register.

The DN directive defines a name for a specified 64-bit extension register.

The SN directive defines a name for a specified single-precision VFP register.

Note

Avoid conflicting uses of the same register under different names.

You cannot specify a vector length in a DN or SN directive.

Examples

```
energy DN 6 ; defines energy as a symbol for VFP double-precision register 6
mass SN 16 ; defines mass as a symbol for VFP single-precision register 16
```

Extended notation examples

```
varA DN d1.U16
varB DN d2.U16
varC DN d3.U16
      VADD varA,varB,varC ; VADD.U16 d1,d2,d3
index DN d4.U16[0]
result QN q5.I32
      VMULL result,varA,index ; VMULL.U16 q5,d1,d4[0]
```

Related concepts

[8.9 NEON data types on page 8-177.](#)

9.22 Overview of VFP directives and vector notation on page 9-214.

8.10 Extended notation extension for NEON on page 8-178.

Related references

2.11 Predeclared core register names on page 2-46.

2.12 Predeclared extension register names on page 2-47.

2.13 Predeclared XScale register names on page 2-48.

2.14 Predeclared coprocessor names on page 2-49.

15.57 RELOC

The RELOC directive explicitly encodes an ELF relocation in an object file.

Syntax

```
RELOC n, symbol
```

```
RELOC n
```

where:

n

must be an integer in the range 0 to 255 or one of the relocation names defined in the Application Binary Interface for the ARM Architecture.

symbol

can be any PC-relative label.

Usage

Use RELOC *n*, *symbol* to create a relocation with respect to the address labeled by *symbol*.

If used immediately after an ARM or Thumb instruction, RELOC results in a relocation at that instruction. If used immediately after a DCB, DCW, or DCD, or any other data generating directive, RELOC results in a relocation at the start of the data. Any addend to be applied must be encoded in the instruction or in the data.

If the assembler has already emitted a relocation at that place, the relocation is updated with the details in the RELOC directive, for example:

```
DCD    sym2 ; R_ARM_ABS32 to sym32
RELOC  55  ; ... makes it R_ARM_ABS32_NOI
```

RELOC is faulted in all other cases, for example, after any non-data generating directive, LTORG, ALIGN, or as the first thing in an AREA.

Use RELOC *n* to create a relocation with respect to the anonymous symbol, that is, symbol 0 of the symbol table. If you use RELOC *n* without a preceding assembler generated relocation, the relocation is with respect to the anonymous symbol.

Examples

```
IMPORT  impsym
LDR     r0,[pc,#-8]
RELOC   4, impsym
DCD     0
RELOC   2, sym
DCD     0,1,2,3,4      ; the final word is relocated
RELOC   38,sym2        ; R_ARM_TARGET1
DCD     impsym
RELOC   R_ARM_TARGET1 ; relocation code 38
```

Related information

[Application Binary Interface for the ARM Architecture.](#)

15.58 REQUIRE

The REQUIRE directive specifies a dependency between sections.

Syntax

REQUIRE *Label*

where:

Label

is the name of the required label.

Usage

Use REQUIRE to ensure that a related section is included, even if it is not directly called. If the section containing the REQUIRE directive is included in a link, the linker also includes the section containing the definition of the specified label.

15.59 REQUIRE8 and PRESERVE8

The REQUIRE8 and PRESERVE8 directives specify that the current file requires or preserves eight-byte alignment of the stack.

Syntax

```
REQUIRE8 {bool}
```

```
PRESERVE8 {bool}
```

where:

bool

is an optional Boolean constant, either {TRUE} or {FALSE}.

Usage

Where required, if your code preserves eight-byte alignment of the stack, use PRESERVE8 to set the PRES8 build attribute on your file. If your code does not preserve eight-byte alignment of the stack, use PRESERVE8 {FALSE} to ensure that the PRES8 build attribute is not set. Use REQUIRE8 to set the REQ8 build attribute. If there are multiple REQUIRE8 or PRESERVE8 directives in a file, the assembler uses the value of the last directive.

The linker checks that any code that requires eight-byte alignment of the stack is only called, directly or indirectly, by code that preserves eight-byte alignment of the stack.

Note

If you omit both PRESERVE8 and PRESERVE8 {FALSE}, the assembler decides whether to set the PRES8 build attribute or not, by examining instructions that modify the SP. ARM recommends that you specify PRESERVE8 explicitly.

You can enable a warning by using the `--diag_warning 1546` option when invoking `armasm`.

This gives you warnings like:

```
"test.s", line 37: Warning: A1546W: Stack pointer update potentially breaks 8 byte stack alignment
37 00000044      STMFD    sp!,{r2,r3,lr}
```

Examples

```
REQUIRE8
REQUIRE8    {TRUE}      ; equivalent to REQUIRE8
REQUIRE8    {FALSE}     ; equivalent to absence of REQUIRE8
PRESERVE8    {TRUE}      ; equivalent to PRESERVE8
PRESERVE8    {FALSE}     ; NOT exactly equivalent to absence of PRESERVE8
```

Related references

[10.23 --diag_warning=tag\[,tag,...\]](#) on page 10-248.

Related information

[Eight-byte Stack Alignment.](#)

15.60 RLIST

The RLIST (register list) directive gives a name to a set of general-purpose registers.

Syntax

```
name RLIST {list-of-registers}
```

where:

name

is the name to be given to the set of registers. *name* cannot be the same as any of the predefined names.

list-of-registers

is a comma-delimited list of register names and register ranges. The register list must be enclosed in braces.

Usage

Use RLIST to give a name to a set of registers to be transferred by the LDM or STM instructions.

LDM and STM always put the lowest physical register numbers at the lowest address in memory, regardless of the order they are supplied to the LDM or STM instruction. If you have defined your own symbolic register names it can be less apparent that a register list is not in increasing register order.

Use the `--diag_warning 1206` assembler option to ensure that the registers in a register list are supplied in increasing register order. If registers are not supplied in increasing register order, a warning is issued.

Example

```
Context RLIST {r0-r6,r8,r10-r12,pc}
```

Related references

[2.11 Predeclared core register names on page 2-46.](#)

[2.12 Predeclared extension register names on page 2-47.](#)

[2.13 Predeclared XScale register names on page 2-48.](#)

[2.14 Predeclared coprocessor names on page 2-49.](#)

15.61 RN

The RN directive defines a name for a specified register.

Syntax

name RN *expr*

where:

name

is the name to be assigned to the register. *name* cannot be the same as any of the predefined names.

expr

evaluates to a register number from 0 to 15.

Usage

Use RN to allocate convenient names to registers, to help you to remember what you use each register for. Be careful to avoid conflicting uses of the same register under different names.

Examples

```
regname    RN 11 ; defines regname for register 11
sqr4       RN r6 ; defines sqr4 for register 6
```

Related references

[2.11 Predeclared core register names](#) on page 2-46.

[2.12 Predeclared extension register names](#) on page 2-47.

[2.13 Predeclared XScale register names](#) on page 2-48.

[2.14 Predeclared coprocessor names](#) on page 2-49.

15.62 ROUT

The ROUT directive marks the boundaries of the scope of numeric local labels.

Syntax

```
{name} ROUT
```

where:

name

is the name to be assigned to the scope.

Usage

Use the ROUT directive to limit the scope of numeric local labels. This makes it easier for you to avoid referring to a wrong label by accident. The scope of numeric local labels is the whole area if there are no ROUT directives in it.

Use the *name* option to ensure that each reference is to the correct numeric local label. If the name of a label or a reference to a label does not match the preceding ROUT directive, the assembler generates an error message and the assembly fails.

Example

```

routineA    ; code
            ROUT          ; ROUT is not necessarily a routine
            ; code
3routineA   ; code          ; this label is checked
            ; code
            BEQ          %4routineA ; this reference is checked
            ; code
            BGE          %3          ; refers to 3 above, but not checked
            ; code
4routineA   ; code          ; this label is checked
            ; code
otherstuff  ROUT          ; start of next scope

```

Related concepts

[7.10 Numeric local labels on page 7-147.](#)

Related references

[15.6 AREA on page 15-767.](#)

15.63 SETA, SETL, and SETS

The SETA, SETL, and SETS directives set the value of a local or global variable.

Syntax

variable setx expr

where:

variable

is the name of a variable declared by a GBLA, GBLL, GBLS, LCLA, LCLL, or LCLS directive.

setx

is one of SETA, SETL, or SETS.

expr

is an expression that is:

- Numeric, for SETA.
- Logical, for SETL.
- String, for SETS.

Usage

The SETA directive sets the value of a local or global arithmetic variable.

The SETL directive sets the value of a local or global logical variable.

The SETS directive sets the value of a local or global string variable.

You must declare *variable* using a global or local declaration directive before using one of these directives.

You can also predefine variable names on the command line.

Examples

VersionNumber	GBLA	VersionNumber
	SETA	21
	GBLL	Debug
Debug	SETL	{TRUE}
	GBLS	VersionString
VersionString	SETS	"Version 1.0"

Related concepts

[7.12 String expressions on page 7-149.](#)

[7.14 Numeric expressions on page 7-151.](#)

[7.17 Logical expressions on page 7-154.](#)

Related references

[15.42 GBLA, GBLL, and GBLS on page 15-806.](#)

[15.49 LCLA, LCLL, and LCLS on page 15-815.](#)

[10.56 --predefine "directive" on page 10-282.](#)

15.64 SPACE or FILL

The SPACE directive reserves a zeroed block of memory. The FILL directive reserves a block of memory to fill with a given value.

Syntax

```
{label} SPACE expr
```

```
{label} FILL expr{,value{,valuesize}}
```

where:

Label

is an optional label.

expr

evaluates to the number of bytes to fill or zero.

value

evaluates to the value to fill the reserved bytes with. *value* is optional and if omitted, it is 0. *value* must be 0 in a NOINIT area.

valuesize

is the size, in bytes, of *value*. It can be any of 1, 2, or 4. *valuesize* is optional and if omitted, it is 1.

Usage

Use the ALIGN directive to align any code following a SPACE or FILL directive.

% is a synonym for SPACE.

Example

```

data1  AREA  MyData, DATA, READWRITE
        SPACE 255 ; defines 255 bytes of zeroed store
data2  FILL  50,0xAB,1 ; defines 50 bytes containing 0xAB

```

Related concepts

[7.14 Numeric expressions on page 7-151.](#)

Related references

[15.5 ALIGN on page 15-765.](#)

[15.15 DCB on page 15-778.](#)

[15.16 DCD and DCDD on page 15-779.](#)

[15.21 DCQ and DCQU on page 15-784.](#)

[15.22 DCW and DCWU on page 15-785.](#)

15.65 THUMB

The THUMB directive instructs the assembler to interpret subsequent instructions as Thumb instructions, using the UAL syntax.

Syntax

```
THUMB
```

Usage

In files that contain code using different instruction sets, THUMB must precede Thumb code written in UAL syntax.

If necessary, this directive also inserts one byte of padding to align to the next halfword boundary.

This directive does not assemble to any instructions. It also does not change the state. It only instructs the assembler to assemble Thumb instructions, and inserts padding if necessary.

ARM and THUMB directives

This example shows how you can use ARM and THUMB directives to switch state and assemble both ARM and Thumb instructions in a single area.

```

        AREA ToThumb, CODE, READONLY ; Name this block of code
        ENTRY                        ; Mark first instruction to execute
        ARM                          ; Subsequent instructions are ARM
start
        ADR    r0, into_thumb + 1    ; Processor starts in ARM state
        BX    r0                    ; Inline switch to Thumb state
        THUMB ; Subsequent instructions are Thumb
into_thumb
        MOVS   r0, #10               ; New-style Thumb instructions

```

Related references

[15.7 ARM or CODE32 on page 15-770.](#)

[15.11 CODE16 on page 15-774.](#)

[15.66 THUMBX on page 15-836.](#)

15.66 THUMBX

The THUMBX directive instructs the assembler to interpret subsequent instructions as ThumbEE instructions, using the UAL syntax.

Syntax

THUMBX

Usage

In files that contain code using different instruction sets, THUMBX must precede ThumbEE code written in UAL syntax.

If necessary, this directive also inserts one byte of padding to align to the next halfword boundary.

This directive does not assemble to any instructions. It also does not change the state. It only instructs the assembler to assemble ThumbEE instructions, and inserts padding if necessary.

Note

- ARM deprecates the use of ThumbEE instructions.
 - For descriptions of ThumbEE instructions, see the ARM Architecture Reference Manual.
-

Related references

[15.7 ARM or CODE32 on page 15-770.](#)

[15.11 CODE16 on page 15-774.](#)

[15.65 THUMB on page 15-835.](#)

Related information

[ARM Architecture Reference Manual.](#)

15.67 TTL and SUBT

The TTL directive inserts a title at the start of each page of a listing file. The SUBT directive places a subtitle on the pages of a listing file.

Syntax

TTL *title*

SUBT *subtitle*

where:

title

is the title.

subtitle

is the subtitle.

Usage

Use the TTL directive to place a title at the top of each page of a listing file. If you want the title to appear on the first page, the TTL directive must be on the first line of the source file.

Use additional TTL directives to change the title. Each new TTL directive takes effect from the top of the next page.

Use SUBT to place a subtitle at the top of each page of a listing file. Subtitles appear in the line below the titles. If you want the subtitle to appear on the first page, the SUBT directive must be on the first line of the source file.

Use additional SUBT directives to change subtitles. Each new SUBT directive takes effect from the top of the next page.

Examples

```
TTL First Title ; places title on first and subsequent pages of listing file.  
SUBT First Subtitle ; places subtitle on second and subsequent pages of listing file.
```

15.68 WHILE and WEND

The WHILE directive starts a sequence of instructions or directives that are to be assembled repeatedly. The sequence is terminated with a WEND directive.

Syntax

```
WHILE Logical-expression  
  code  
WEND
```

where:

Logical-expression

is an expression that can evaluate to either {TRUE} or {FALSE}.

Usage

Use the WHILE directive, together with the WEND directive, to assemble a sequence of instructions a number of times. The number of repetitions can be zero.

You can use IF . . . ENDIF conditions within WHILE . . . WEND loops.

WHILE . . . WEND loops can be nested.

Example

```
count  GBLA  count          ; declare local variable  
       SETA  1             ; you are not restricted to  
count  WHILE count <= 4   ; such simple conditions  
       SETA  count+1       ; In this case, this code is  
       ; code              ; executed four times  
       ; code              ;  
       WEND
```

Related concepts

[7.17 Logical expressions on page 7-154.](#)

Related references

[15.2 About assembly control directives on page 15-762.](#)

Chapter 16

Via File Syntax

Describes the syntax of via files accepted by `armasm`.

It contains the following sections:

- [16.1 Overview of via files on page 16-840.](#)
- [16.2 Via file syntax rules on page 16-841.](#)

16.1 Overview of via files

Via files are plain text files that allow you to specify assembler command-line arguments and options.

Typically, you use a via file to overcome the command-line length limitations. However, you might want to create multiple via files that:

- Group similar arguments and options together.
- Contain different sets of arguments and options to be used in different scenarios.

Note

In general, you can use a via file to specify any command-line option to a tool, including `--via`. This means that you can call multiple nested via files from within a via file.

Via file evaluation

When the assembler is invoked it:

1. Replaces the first specified `--via via_file` argument with the sequence of argument words extracted from the via file, including recursively processing any nested `--via` commands in the via file.
2. Processes any subsequent `--via via_file` arguments in the same way, in the order they are presented.

That is, via files are processed in the order you specify them, and each via file is processed completely including processing nested via files before processing the next via file.

Related references

[16.2 Via file syntax rules on page 16-841.](#)

[10.68 `--via=filename` on page 10-294.](#)

16.2 Via file syntax rules

Via files must conform to some syntax rules.

- A via file is a text file containing a sequence of words. Each word in the text file is converted into an argument string and passed to the tool.
- Words are separated by whitespace, or the end of a line, except in delimited strings, for example:

```
--bigend --reduce_paths (two words)
```

```
--bigend--reduce_paths (one word)
```

- The end of a line is treated as whitespace, for example:

```
--bigend
--reduce_paths
```

This is equivalent to:

```
--bigend --reduce_paths
```

- Strings enclosed in quotation marks ("), or apostrophes (') are treated as a single word. Within a quoted word, an apostrophe is treated as an ordinary character. Within an apostrophe delimited word, a quotation mark is treated as an ordinary character.

Use quotation marks to delimit filenames or path names that contain spaces, for example:

```
--errors C:\My Project\errors.txt (three words)
```

```
--errors "C:\My Project\errors.txt" (two words)
```

Use apostrophes to delimit words that contain quotes, for example:

```
-DNAME=' "ARM Compiler"' (one word)
```

- Characters enclosed in parentheses are treated as a single word, for example:

```
--option(x, y, z) (one word)
```

```
--option (x, y, z) (two words)
```

- Within quoted or apostrophe delimited strings, you can use a backslash (\) character to escape the quote, apostrophe, and backslash characters.
- A word that occurs immediately next to a delimited word is treated as a single word, for example:

```
--errors"C:\Project\errors.txt"
```

This is treated as the single word:

```
--errorsC:\Project\errors.txt
```

- Lines beginning with a semicolon (;) or a hash (#) character as the first nonwhitespace character are comment lines. A semicolon or hash character that appears anywhere else in a line is not treated as the start of a comment, for example:

```
-o objectname.axf ;this is not a comment
```

A comment ends at the end of a line, or at the end of the file. There are no multi-line comments, and there are no part-line comments.

Related concepts

[16.1 Overview of via files on page 16-840.](#)

Related references

[10.68 --via=filename on page 10-294.](#)

Appendix A

Assembler Document Revisions

Describes the technical changes that have been made to the *armasm* User Guide.

It contains the following sections:

- [A.1 Revisions for *armasm* User Guide](#) on page [Appx-A-843](#).

A.1 Revisions for armasm User Guide

The following technical changes have been made to the armasm User Guide.

Table A-1 Differences between issue L and issue M

Change	Topics affected
Removed references to <code>--licretry</code> as the option no longer has an effect.	<code>--licretry</code>

Table A-2 Differences between issue K and issue L

Change	Topics affected
Added v7E-M row and added underscores to entries in the XX column where required.	6.4 Built-in variables and constants on page 6-118
Removed <i>IBLE</i> from all instances of SETCOMPATIBLEWITHVALUE and SETCOMPATIBLEWITHSTRING.	15.9 ATTR on page 15-772
Clarified that <code>--cpreproc_opts</code> must contain at least one option.	10.13 --cpreproc_opts=option[,option,...] on page 10-236
Moved the NEON and VFP instructions into separate chapters.	<ul style="list-style-type: none"> Chapter 12 NEON Instructions on page 12-571 Chapter 13 VFP Instructions on page 13-712
Added the <i>option</i> operand. Removed the <i>Label</i> operand from STC{2}.	<ul style="list-style-type: none"> 11.40 LDC and LDC2 on page 11-370 11.134 STC and STC2 on page 11-499
Clarified that RSC is not available in Thumb code.	11.95 RSC on page 11-454
Removed the distinction between signed and unsigned types from the store instructions.	<ul style="list-style-type: none"> 11.136 STR (immediate offset) on page 11-503 11.137 STR (register offset) on page 11-506 11.138 STR, unprivileged on page 11-509
Removed the <i>Label</i> form of the VSTR NEON and VFP instructions.	<ul style="list-style-type: none"> 13.32 VSTR (floating-point) on page 13-746 12.120 VSTR on page 12-701
Added some missing VMOV instructions to the table.	13.1 Summary of VFP instructions on page 13-714
Corrected the availability for SDIV and UDIV instructions.	<ul style="list-style-type: none"> 11.1 ARM and Thumb instruction summary on page 11-303 11.158 UDIV on page 11-536 11.101 SDIV on page 11-463
Removed mention of register <i>Rd</i> and added that LDREXB and LDREXH zero extend the value loaded.	11.48 LDREX on page 11-390
Removed mention of the accumulator and the <i>Ra</i> operand.	<ul style="list-style-type: none"> 11.124 SMULxy on page 11-488 11.126 SMULWy on page 11-490
Removed the description of <code>--device=name</code> .	Chapter 10 Assembler Command-line Options on page 10-221

Table A-3 Differences between issue J and issue K

Change	Topics affected
Added generic notes about supported features in ARM Compiler and code generation between releases.	<i>1.1 About the ARM Compiler toolchain assemblers on page 1-28</i>
Mentioned how to enable and disable alignment checking in ARMv7-M.	<i>6.16 Address alignment on page 6-134</i>
Removed the single quotation marks from the example.	<i>10.13 --cpreproc_opts=option[,option,...] on page 10-236</i>
Corrected the description of <i>Rm</i> in LSL.	<i>11.49 LSL on page 11-392</i>
Added a note about ECC memory to the AREA NOINIT attribute description.	<i>15.6 AREA on page 15-767</i>
Mentioned that there is no 16-bit version of the RBIT instruction in Thumb.	<i>11.87 RBIT on page 11-442</i>
Mentioned the instruction sets supported by the ARMv7 architecture profiles.	<i>2.2 ARM, Thumb, and ThumbEE instruction sets on page 2-36</i>
Included Hyp mode in the diagram and description.	<i>2.8 ARM registers on page 2-42</i>
Added a note to explain the purpose of the example.	<i>4.17 Block copy with LDM and STM on page 4-85</i>
Clarified that LDRD and STRD doubleword data transfers must be eight-byte aligned only in ARMv5TE, or in ARMv6 when SCTL.R.U is 0.	<i>15.5 ALIGN on page 15-765</i>
Updated topics for VFPv4.	<ul style="list-style-type: none"> • <i>2.7 VFP hardware on page 2-41</i> • <i>8.4 Extension register bank mapping in NEON on page 8-171</i> • <i>9.5 VFP views of the extension register bank on page 9-196</i> • <i>8.17 Flush-to-zero mode in NEON on page 8-185</i>
Added the HVC instruction.	<i>11.37 HVC on page 11-366</i>
Clarified that <i>width+Lsb</i> can be equal to 32.	<ul style="list-style-type: none"> • <i>11.18 BFI on page 11-338</i> • <i>11.17 BFC on page 11-337</i>
Removed the ThumbEE instructions and removed information specific to ThumbEE instructions from the ARM and Thumb Instructions chapter. Mentioned that information about ThumbEE instructions can be found in the <i>ARM Architecture Reference Manual</i> .	<ul style="list-style-type: none"> • <i>Chapter 11 ARM and Thumb Instructions on page 11-298</i> • <i>10.63 --thumbx on page 10-289</i> • <i>15.66 THUMBX on page 15-836</i>
Modified the Address alignment topic.	<i>6.16 Address alignment on page 6-134</i>
Clarified the description of PC-relative expressions.	<i>7.5 Register-relative and PC-relative expressions on page 7-142</i>
Removed the description of <code>--device=list</code> .	<i>Chapter 10 Assembler Command-line Options on page 10-221</i>

Table A-4 Differences between issue I and issue J

Change	Topics affected
Added the chapters from the <i>Assembler Reference</i> into the <i>armasm User Guide</i> . The <i>Assembler Reference</i> is no longer being provided as a separate document.	<ul style="list-style-type: none"> • Chapter 10 Assembler Command-line Options on page 10-221 • Chapter 11 ARM and Thumb Instructions on page 11-298 • Chapter 12 NEON Instructions on page 12-571 • Chapter 14 Wireless MMX Technology Instructions on page 14-749 • Chapter 15 Directives Reference on page 15-759
Added the <code>--execute_only</code> command-line option.	10.29 --execute_only on page 10-254
Added the EXECONLY and ZEROALIGN AREA attributes, and mentioned that CODEALIGN is the default for execute-only sections.	15.6 AREA on page 15-767
Changed references to the assembler environment variable from ARMCCn_ASMOPT to ARMCC5_ASMOPT.	<ul style="list-style-type: none"> • 6.2 Specify command-line options with an environment variable on page 6-116 • <code>--licretry</code>
<code>--cpu</code> and <code>--fpu</code> options are fully documented	<ul style="list-style-type: none"> • 10.15 --cpu=name on page 10-238 • 10.34 --fpu=name on page 10-259
Added topics on via file syntax.	<ul style="list-style-type: none"> • 16.1 Overview of via files on page 16-840 • 16.2 Via file syntax rules on page 16-841
Removed the topics <code>--project</code> , <code>--no_project</code> , <code>--reinitialize_workdir</code> , and <code>--workdir</code> .	<ul style="list-style-type: none"> • Chapter 10 Assembler Command-line Options on page 10-221
Mentioned a difference in behavior between pre-UAL Thumb syntax and UAL syntax for the <code>LDR Rd, = const</code> literal load pseudo-instruction.	<ul style="list-style-type: none"> • 4.28 Assembly language changes after RVCT v2.1 on page 4-99

Table A-5 Differences between issue H and issue I

Change	Topics affected
Where appropriate, changed the term <i>local label</i> to either <i>numeric local label</i> or <i>named local label</i> .	<ul style="list-style-type: none"> • 3.1 Syntax of source lines in assembly language on page 3-58 • 7.1 Symbol naming rules on page 7-138 • 7.10 Numeric local labels on page 7-147 • 7.11 Syntax of numeric local labels on page 7-148 • 15.48 KEEP on page 15-814 • 15.62 ROUT on page 15-832 • 10.38 --keep on page 10-264 • 10.66 --untyped_local_labels on page 10-292 • 11.46 LDR pseudo-instruction on page 11-386
Replaced or removed the term UNPREDICTABLE.	Various instructions
Clarified how the carry flag is set.	5.4 Updates to the condition flags on page 5-105
Where appropriate, changed the terminology that implied that 16-bit Thumb and 32-bit Thumb are separate instruction sets.	Various topics

Table A-5 Differences between issue H and issue I (continued)

Change	Topics affected
Where appropriate, changed the term <i>processor state</i> to <i>instruction set state</i> .	<ul style="list-style-type: none"> 2.3 Changing between ARM, Thumb, and ThumbEE state on page 2-37 2.18 Current Program Status Register on page 2-53 2.19 Saved Program Status Registers on page 2-54 11.24 BXJ on page 11-348
Clarified the difference between changing the assembler mode and changing the instruction set state.	2.3 Changing between ARM, Thumb, and ThumbEE state on page 2-37
Mentioned that DMB, DSB and ISB cannot be conditional in ARM code.	<ul style="list-style-type: none"> 11.33 DMB on page 11-359 11.34 DSB on page 11-361 11.38 ISB on page 11-367
Corrected the available immediate ranges for VQ{R}SHR{U}N and mentioned the I16, I32, and I64 datatypes.	<ul style="list-style-type: none"> 12.92 VQRSHRN and VQRSHRUN (by immediate) on page 12-671 12.95 VQSHRN and VQSHRUN (by immediate) on page 12-674
Mentioned that VFP vector mode and mixed mode are deprecated, for the following VFP instructions: VABS, VADD, VDIV, VMLA, VMLS, VMUL, VNEG, VNMLA, VNMLS, VNMUL, VSQRT, and VSUB.	Chapter 8 NEON Programming on page 8-167
Described the E suffix for the VCMP instruction.	13.4 VCMP, VCMPE on page 13-718
Added the non flag-setting forms to the lists of 16-bit Thumb instructions, for the following instructions: ADC, ADD, AND, ASR, BIC, EOR, LSL, LSR, MOV, MUL, ORR, ROR, RSB, SBC, and SUB. Also mentioned that the corresponding flag-setting forms can only be used outside IT blocks.	Chapter 11 ARM and Thumb Instructions on page 11-298
Corrected the examples given for the DCQ and DCQU directives.	15.21 DCQ and DCQU on page 15-784

Table A-6 Differences between issue G and issue H

Change	Topics affected
Added a topic about conditional assembly.	6.14 Conditional assembly on page 6-131
Clarified the difference between the <code>--predefine</code> assembler option and the <code>Dname</code> compiler option.	10.56 <code>--predefine</code> "directive" on page 10-282
Mentioned behavior when using PC or SP with the MRS or MSR instructions.	<ul style="list-style-type: none"> 11.63 MRS (PSR to general-purpose register) on page 11-410 11.66 MSR (general-purpose register to PSR) on page 11-414
Added a note about using the ISB instruction in an IT block on ARMv7-M.	11.38 ISB on page 11-367
Separated the V{R}SHR, V{R}SHRN and V{R}SRA instruction descriptions and changed the descriptions of the valid immediate ranges.	<ul style="list-style-type: none"> 12.112 VSHR (by immediate) on page 12-691 12.113 VSHRN (by immediate) on page 12-692 12.115 VSRA (by immediate) on page 12-694 12.103 VRSHR (by immediate) on page 12-682 12.104 VRSHRN (by immediate) on page 12-683 12.107 VRSRA (by immediate) on page 12-686

Table A-6 Differences between issue G and issue H (continued)

Change	Topics affected
Changed the terminology used for ARM architecture versions and added explanatory table footnotes.	<ul style="list-style-type: none"> • 11.11 ADR (PC-relative) on page 11-325 • 11.12 ADR (register-relative) on page 11-327 • 11.42 LDR (immediate offset) on page 11-374 • 11.137 STR (register offset) on page 11-506 • 11.47 LDR, unprivileged on page 11-388 • 11.43 LDR (PC-relative) on page 11-377 • 11.45 LDR (register-relative) on page 11-383
Added the CPY and NEG pseudo-instructions.	<ul style="list-style-type: none"> • 11.31 CPY pseudo-instruction on page 11-357 • 11.69 NEG pseudo-instruction on page 11-420
Expanded the Usage and Example sections for the ENTRY directive.	15.25 ENTRY on page 15-788

Table A-7 Differences between issue F and issue G

Change	Topics affected
Changed the ordering of some operands from vector, scalar, vector to vector, vector, scalar, in the examples of VFP arithmetic instructions.	<ul style="list-style-type: none"> • 9.25 VFPASSERT SCALAR on page 9-218 • 9.26 VFPASSERT VECTOR on page 9-219
Where appropriate: <ul style="list-style-type: none"> • Mentioned Thumb-2 technology. • Changed 32-bit Thumb to Thumb-2 technology. 	<ul style="list-style-type: none"> • 2.2 ARM, Thumb, and ThumbEE instruction sets on page 2-36 • 2.20 ARM and Thumb instruction set overview on page 2-55
Updated the description of <code>--untyped_local_labels</code> .	10.66 --untyped_local_labels on page 10-292
Added the ERET instruction.	11.36 ERET on page 11-365
Mentioned that the MVN instruction exists in a 16-bit Thumb encoding.	11.68 MVN on page 11-418
Added a figure showing the operation of VSHL and updated the figures for VSLI and VSRI.	<ul style="list-style-type: none"> • 12.109 VSHL (by immediate) on page 12-688 • 12.114 VSLI on page 12-693 • 12.116 VSRI on page 12-695
Added links to the NEON and VFP data types topic from the associated NEON and VFP instructions.	Various NEON and VFP instructions
Mentioned that the FUNCTION directive can accept an empty regist.	15.41 FUNCTION or PROC on page 15-805

Table A-8 Differences between issue E and issue F

Change	Topics affected
Clarified the range of addresses accessible to the ADR instruction and the ADRL pseudo-instruction in ARM state.	<ul style="list-style-type: none"> • Address range for the ADR instruction • 11.13 ADRL pseudo-instruction on page 11-329
Where appropriate: <ul style="list-style-type: none"> • Changed Thumb-2 to 32-bit Thumb. • Changed Thumb-2EE to ThumbEE. 	Various topics
Changed the minor version component of the built-in variable <code>ARMASM_VERSION</code> from one to two digits.	6.4 Built-in variables and constants on page 6-118
Changed the minor version component of the integer reported by the <code>--version_number</code> option from one to two digits.	10.67 --version_number on page 10-293

Table A-8 Differences between issue E and issue F (continued)

Change	Topics affected
Modified the description of <code>--vsn</code> .	10.69 --vsn on page 10-295
Added a note that the <code>--device</code> option is deprecated.	<ul style="list-style-type: none"> <code>--device=list</code> <code>--device=name</code>
Modified the description of <code>--licretry</code> .	<code>--licretry</code>
Mentioned a restriction on using LSL in an IT block with a zero value for <code>sh</code> .	11.49 LSL on page 11-392

Table A-9 Differences between issue D and issue E

Change	Topics affected
Added SC300 and SC000 to table of <code>--compatible</code> options.	10.11 --compatible=name on page 10-234

Table A-10 Differences between issue C and issue D

Change	Topics affected
Added note about <code>--use_frame_pointer</code> .	2.9 General-purpose registers on page 2-44
Changed ARMCC41* environment variables to ARMCCnn*. Added a link to the topic Toolchain environment variables.	6.2 Specify command-line options with an environment variable on page 6-116
Added a topic on directives that can be omitted in pass 2 and added a link to this topic from <i>How the assembler works</i> .	1.4 Directives that can be omitted in pass 2 of the assembler on page 1-32
Added that all instructions must appear in both passes.	1.3 How the assembler works on page 1-30
In the summary table, changed instruction mnemonics from: <ul style="list-style-type: none"> VQRSHR to VQRSHR{U}N. VQSHR to VQSHR{U}N. VRSUBH to VRSUBHN. VSUBH to VSUBHN. VRADDH to VRADDHN. 	12.1 Summary of NEON instructions on page 12-574
Added GBLA count to the example.	15.68 WHILE and WEND on page 15-838
Changed FPv4_SP to FPv4-SP.	10.34 --fpu=name on page 10-259
Made changes to ALinknames for MRS, MSR, SEV, SYS, and NOP instructions.	<ul style="list-style-type: none"> 11.65 MSR (ARM register to system coprocessor register) on page 11-413 11.64 MRS (system coprocessor register to ARM register) on page 11-412 11.150 SYS on page 11-526 11.104 SEV on page 11-467 11.70 NOP on page 11-421

Table A-11 Differences between issue B and issue C

Change	Topics affected
Added topic on 2 pass assembler diagnostics.	6.13 Two pass assembler diagnostics on page 6-130
Added topic on How the assembler works.	1.3 How the assembler works on page 1-30
Changed the restrictions to say that R \bar{t} must be even-numbered only in LDREXD and STREXD instructions.	<ul style="list-style-type: none"> 11.48 LDREX on page 11-390 11.139 STREX on page 11-511

Table A-11 Differences between issue B and issue C (continued)

Change	Topics affected
Mentioned the additional cases where SP and PC are deprecated.	<ul style="list-style-type: none"> • 11.48 LDREX on page 11-390 • 11.10 ADD on page 11-322 • 11.57 MOV on page 11-403 • 11.40 LDC and LDC2 on page 11-370
Mentioned that deprecation of SP and PC is only in ARMv6T2 and above.	Various instructions
Added example of inconsistent use of MAP and FIELD directives.	15.29 FIELD on page 15-793
Changed <code>--cpu PXA270</code> to <code>--device PXA270</code> .	14.1 About Wireless MMX Technology instructions on page 14-750

Table A-12 Differences between issue A and issue B

Change	Topics affected
Split the General-purpose registers topic into two. The second topic is called Register accesses.	<ul style="list-style-type: none"> • 2.9 General-purpose registers on page 2-44 • 2.10 Register accesses on page 2-45
Mentioned that PC is not considered to be a general-purpose register and that the instruction topics describe when SP and PC can be used.	2.9 General-purpose registers on page 2-44
Mentioned that the use of PC in reglist in 32-bit Thumb instructions is for LDM and POP only.	<ul style="list-style-type: none"> • 11.41 LDM on page 11-372 • 11.135 STM on page 11-501 • 11.76 PUSH on page 11-431 • 11.75 POP on page 11-429
Added a note that ARM instructions are deprecated if reglist contains SP or PC (STM and PUSH), or both PC and LR (LDM and POP).	<ul style="list-style-type: none"> • 11.41 LDM on page 11-372 • 11.135 STM on page 11-501 • 11.76 PUSH on page 11-431 • 11.75 POP on page 11-429
Added a topic on Instruction and directive relocations.	4.24 Instruction and directive relocations on page 4-94
Added a topic on Thumb code size diagnostics.	6.10 Thumb code size diagnostics on page 6-127
Added a topic on ARM and Thumb instruction portability diagnostics.	6.11 ARM and Thumb instruction portability diagnostics on page 6-128
Added a link to Thumb code size diagnostics.	6.17 Instruction width selection in Thumb on page 6-135
Added that symbols beginning with \$v must be avoided.	7.1 Symbol naming rules on page 7-138
Removed as an alias for :OR:	7.24 Addition, subtraction, and logical operators on page 7-161
Clarified that NEON is optionally available on ARMv7-A and ARMv7-R but not on ARMv7E-M. Clarified that ARMv7E-M adds only the VFP single-precision floating-point instructions.	8.1 Architecture support for NEON on page 8-168
Added a new topic on how to input assembly code using stdin.	6.3 Using stdin to input source code to the assembler on page 6-117
Added the options <code>--execstack</code> and <code>--no_execstack</code> .	10.28 --execstack, --no_execstack on page 10-253
Updated the description of <code>--cpu=name</code> .	10.15 --cpu=name on page 10-238
Added the option <code>--fpmode=none</code> .	10.32 --fpmode=model on page 10-257

Table A-12 Differences between issue A and issue B (continued)

Change	Topics affected
Updated the description of <code>--show_cmdline</code> .	10.60 --show_cmdline on page 10-286
Updated the instruction summary table and footnotes with ARMv7E-M.	11.1 ARM and Thumb instruction summary on page 11-303
Replaced "profile" with "architecture" when referring to ARMv6-M, ARMv7-M, ARMv7-R, and ARMv7-A in the instruction summary table and in the architecture sections of the instruction descriptions.	11.1 ARM and Thumb instruction summary on page 11-303
Mentioned register-controlled shift in the description of Operand2.	11.5 Syntax of Operand2 as a register with optional shift on page 11-314
Added register restrictions to ADR (PC-relative).	11.11 ADR (PC-relative) on page 11-325
Added register restrictions and deprecation information in LDR and STR (immediate offset).	<ul style="list-style-type: none"> 11.42 LDR (immediate offset) on page 11-374 11.136 STR (immediate offset) on page 11-503
Identified the ARM only instruction syntaxes in LDR and STR (register offset).	<ul style="list-style-type: none"> 11.44 LDR (register offset) on page 11-380 11.137 STR (register offset) on page 11-506
Added register restrictions and deprecation information, use of SP, and use of PC in LDR and STR (register offset).	<ul style="list-style-type: none"> 11.44 LDR (register offset) on page 11-380 11.137 STR (register offset) on page 11-506
Noted that PC-relative STR is available but deprecated.	11.43 LDR (PC-relative) on page 11-377
Added information about deprecation and use of SP in LDR (PC-relative).	11.43 LDR (PC-relative) on page 11-377
In Restrictions on reglist in ARM instructions, added that reglist containing both PC and LR in ARM LDM is deprecated.	11.41 LDM on page 11-372
Added Restrictions of reglist in ARM instructions.	11.75 POP on page 11-429
Added register restriction for <i>Rn</i> and moved the statement " <i>Rm</i> must not be PC" to this section.	11.74 PLD, PLDW, and PLI on page 11-427
Added restrictions on reglist in LDM and STM.	<ul style="list-style-type: none"> 11.41 LDM on page 11-372 11.135 STM on page 11-501
Added the statement "must not be PC" for each of the registers in the syntax.	11.143 SWP and SWPB on page 11-518
Mentioned <code>SUBS pc, lr</code> in Use of PC and SP in ARM instructions.	11.10 ADD on page 11-322
Removed the caution against the use of the S suffix when using PC as <i>Rd</i> in User or System mode.	11.10 ADD on page 11-322
Mentioned the deprecated instructions that use PC.	11.10 ADD on page 11-322
Added more syntaxes that are only present in ARM code and described the additional items in the syntax.	11.141 SUBS pc, lr on page 11-515
Documented the valid forms of the SUBS instruction in ARM and Thumb, and added the caution to not use these instructions in User or System mode.	11.141 SUBS pc, lr on page 11-515
Mentioned <code>SUBS pc, lr</code> in Use of PC and SP in ARM instructions.	11.14 AND on page 11-331
Removed the caution against the use of the S suffix when using PC as <i>Rd</i> in User or System mode.	11.14 AND on page 11-331
Added Register restrictions section to say <i>Rn</i> cannot be PC in instructions that write back to <i>Rn</i> .	11.40 LDC and LDC2 on page 11-370
Mentioned that <i>Rt</i> cannot be PC.	11.52 MCR and MCR2 on page 11-397

Table A-12 Differences between issue A and issue B (continued)

Change	Topics affected
Mentioned that <i>Rm</i> cannot be PC.	11.66 MSR (general-purpose register to PSR) on page 11-414
Mentioned <code>SUBS pc, lr</code> in Use of PC and SP in ARM MOV.	11.57 MOV on page 11-403
Removed the caution against the use of the <i>S</i> suffix when using PC as <i>Rd</i> in User or System mode.	11.57 MOV on page 11-403
Mentioned the deprecated instructions that use PC.	11.57 MOV on page 11-403
Mentioned that SP is not permitted in Thumb TST and TEQ instructions, and is deprecated in ARM TST and TEQ instructions.	<ul style="list-style-type: none"> 11.153 TST on page 11-530 11.152 TEQ on page 11-528
Added that SEL is available in ARMv7E-M.	11.102 SEL on page 11-464
Added that <i>Rn</i> must be different from <i>Rd</i> in MUL and MLA before ARMv6.	<ul style="list-style-type: none"> 11.67 MUL on page 11-416 11.55 MLA on page 11-401
Added that <i>Rn</i> must be different from <i>RdLo</i> and <i>RdHi</i> before ARMv6.	11.167 UMULL on page 11-545
Added that the Thumb instructions are available in ARMv7E-M.	<ul style="list-style-type: none"> 11.124 SMULxy on page 11-488 11.126 SMULWy on page 11-490 11.116 SMLALxy on page 11-480 11.123 SMUAD on page 11-487 11.122 SMMUL on page 11-486 11.113 SMLAD on page 11-477 11.115 SMLALD on page 11-479 11.165 UMAAL on page 11-543 11.77 QADD on page 11-432 11.175 USAD8 on page 11-553 11.130 SSAT16 on page 11-495 11.147 SXTB on page 11-522 11.73 PKHBT and PKHTB on page 11-425
DBG is available in ARMv6K and above in ARM, and in ARMv6T2 and above in Thumb. Also mentioned that DBG executes as NOP in ARMv6K and ARMv6T2.	11.32 DBG on page 11-358
Added figures for the operation of VSLI and VSRI.	<ul style="list-style-type: none"> 12.114 VSLI on page 12-693 12.116 VSRI on page 12-695
Added tables showing the register state before and after operation of VUZP and VZIP.	<ul style="list-style-type: none"> 12.129 VUZP on page 12-710 12.130 VZIP on page 12-711
Added that <i>n</i> can be a defined relocation name and added a related example in the examples section.	15.57 RELOC on page 15-827
Added a note for a macro workaround when using <code> </code> .	15.51 MACRO and MEND on page 15-817
Clarified the message to say that error generation is during assembly rather than second pass of the assembly.	15.8 ASSERT on page 15-771
Added the ALIAS directive.	15.4 ALIAS on page 15-764
Clarified that <i>n</i> is any integer, and described the examples in the examples sections.	15.5 ALIGN on page 15-765
Clarified the description of COMGROUP and GROUP.	15.6 AREA on page 15-767
Added note about R_ARM_TARGET1.	15.6 AREA on page 15-767

Table A-12 Differences between issue A and issue B (continued)

Change	Topics affected
Added link to 8 Byte Stack Alignment.	15.59 REQUIRE8 and PRESERVE8 on page 15-829
Added /hardfp and /softfp values to the --apcs option and added a link to the --apcs compiler option.	10.3 --apcs=qualifier...qualifier on page 10-225